



# FIBER-OPTIC SENSORS AND FIBERS

FIT FLEXIBLY INTO THE NARROWEST CORNERS

Photoelectric sensors

**SICK**  
Sensor Intelligence.

REGISTER NOW AT  
[WWW.SICK.COM](http://WWW.SICK.COM) AND ENJOY  
THE FOLLOWING BENEFITS



- View net price and individual discount for each product.
- Simple ordering and delivery tracking.
- Overview of all quotes and orders.
- Create, save and share personalized wish lists.
- Direct ordering: place large orders quickly.
- Status of all quotes and orders. Notification by e-mail in the event of status changes.
- Simple reuse of previous orders.
- Convenient export of quotes and orders in the right format for your systems.

## SYSTEMS



Proximity system



Through-beam system

## DESIGN



Threaded sleeve



Flat design



Smooth sleeve

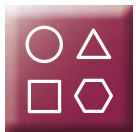


Long end sleeve



90° deflection

## FIELDS OF APPLICATION



Area detection



LCDs/transparent objects/semiconductors



Heat-resistant



Robotics



Oil and chemical resistant



Flexible fibers



Liquid level

## 3 STEPS TO FINDING SUITABLE FIBERS



### 1. Icon overview

Select the design or application for the fibers. The applicable characteristics are highlighted in color in the selection table.  
→ Page A-6

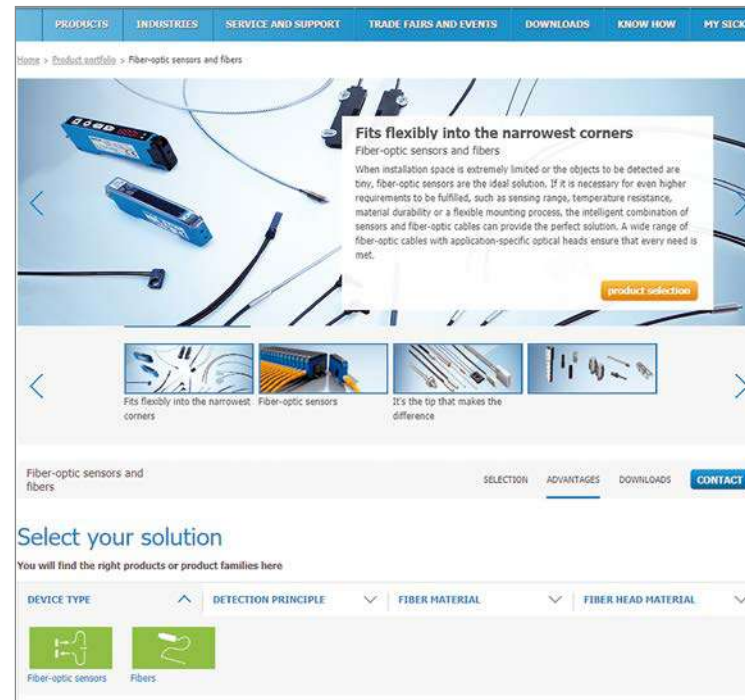
### 2. Fiber categories

Select the fibers that are suitable for your application.  
→ Page B-16

### 3. Fiber-optic sensors

Select one of the amplifiers.  
→ Page D-86

→ [www.sick.com/lichtleiter](http://www.sick.com/lichtleiter)



## ADDITIONAL PRODUCT INFORMATION

You can find further technical data about fibers along with dimensional drawings and 3D CAD files in the product finder for fibers at [www.sick.com](http://www.sick.com).



**OVERVIEW/SELECTION GUIDES**

Systems and design, fields of application, selection guide

**A**



**FIBERS**  
LL3

**B**



**ADAPTER LENSES**  
LL3

**C**



**FIBER-OPTIC SENSORS**  
GLL170, WLL180T

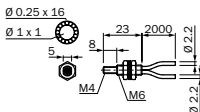
**D**



**ACCESSORIES**

Mounting systems, reflectors and optics, connectivity

**E**



**DIMENSIONAL DRAWINGS**

Fiber-optic cables, tip adapters

**F**

**ANNEX**

Index

**G**

## SYSTEMS

A



Proximity system

- Sender and receiver fibers are enclosed together or combined in a single sensor head
- Recognition of measuring object by detecting the light beam reflected from the object
- Optical axis does not need to be adjusted
- Reflective or transparent measuring object can be detected
- Easy mounting
- Ideal for color and position markings



Through-beam system

- Sender and receiver fibers are mounted separately
- Detection of measuring object by moving the optical axis between sender and receiver
- Very large sensing ranges
- Accurate positioning
- Stable measuring position
- Optically opaque measuring object can be detected regardless of their shape, color, or material
- Strong light beam

## DESIGN



Threaded sleeve

- Quick and easy mounting
- Models with hexagonal flange for trouble-free mounting with only one nut
- Optional tip adapter for a larger detection distance and detection of small objects



Smooth sleeve

- For installation in areas with limited space
- The smooth sleeve is simply secured with a setscrew



90° deflection

- Space-saving installation
- Axial cable outlet option available to avoid loops and possible cable damage



Flat design

- Easy mounting
- Flush mounting in a single slot
- Detection of objects in the background are minimized



Long end sleeve

- Sensor tip can be positioned close to the object
- Flexible end sleeves are available
- Fits in tight spaces

# FIELDS OF APPLICATION



Area detection

- Detection of objects with different shapes
- Detection of moving and free-falling objects
- Leading edge detection



Heat-resistant

- Heat-resistant plastic and glass fibers
- Glass fibers with metallic sheath
- Suitable for high-temperature applications up to +350 °C



Oil and chemical resistant

- PTFE sheath
- Resistant to a wide range of chemicals and cleaning agents
- Suitable for the food and beverage industry



Liquid level

- Fibers for tube mounting and for immersion into liquids
- Models for immersion are made of PTFE and are suitable for the food industry
- Leakage detection
- Fibers for non-contact detection of liquids (in conjunction with a fiber-optic sensor with infrared sender LED)



LCDs/transparent objects/semiconductors

- Detection of glass lead frames
- Detection of solar wafers
- Indexing, e.g., in FOUP (Front Opening Unified Pod)



Robotics

- Ideal for repeated bending
- Presence detection in the gripper



Flexible fibers

- Easy installation around small corners
- 1 mm bend radius




































































































































































































































































































































Fiber-optic proximity systems

A

Type	Design	Application	Page
LL3-DB01	M6	100 °C	→ B-18
LL3-DB01-10	M6	100 °C	→ B-18
LL3-DB01-3	M6	100 °C	→ B-19
LL3-DB01-30	M6	100 °C	→ B-19
LL3-DB02	M3	100 °C	→ B-45
LL3-DB03	M6	100 °C	→ B-19
LL3-DB04	M6	100 °C	→ B-19
LL3-DB05	M3	100 °C	→ B-45
LL3-DB06	M3	100 °C	→ B-46
LL3-DB07	M3	100 °C	→ B-19
LL3-DB08	M3	100 °C	→ B-46
LL3-DB09	M3	100 °C	→ B-32
LL3-DB10	M3	100 °C	→ B-26
LL3-DC03	M3	100 °C	→ B-39, B-64
LL3-DC04	M3	100 °C	→ B-39, B-65, B-68, B-72
LL3-DC05	M3	100 °C	→ B-40, B-65
LL3-DC06	M3	100 °C	→ B-40, B-65, B-68, B-72
LL3-DC07	M3	100 °C	→ B-40, B-65
LL3-DC08	M3	100 °C	→ B-40, B-65
LL3-DC09	M3	100 °C	→ B-40, B-65
LL3-DC38	M3	100 °C	→ B-40, B-65
LL3-DC39	M3	100 °C	→ B-40, B-65
LL3-DC47	M3	100 °C	→ B-40, B-73
LL3-DE01	M3	100 °C	→ B-41, B-73
LL3-DE02	M3	100 °C	→ B-41, B-73



Type	Design	Application	Page
LL3-DE03	    	      	→ B-41, B-73
LL3-DE04	    	      	→ B-41, B-73
LL3-DF02-S01	    	      	→ B-60
LL3-DF04	    	      	→ B-61
LL3-DF05	    	      	→ B-61
LL3-DF07	    	      	→ B-61
LL3-DH01	    	      	→ B-19, B-53
LL3-DH01-03	    	      	→ B-19, B-53
LL3-DH02	    	      	→ B-19, B-54
LL3-DH03	    	      	→ B-54
LL3-DH04	    	      	→ B-46, B-54
LL3-DH05	    	      	→ B-46, B-54
LL3-DH06	    	      	→ B-41, B-54, B-65
LL3-DH07	    	      	→ B-54
LL3-DH08	    	      	→ B-41, B-54, B-66
LL3-DH10	    	      	→ B-41, B-54, B-66
LL3-DH11	    	      	→ B-41, B-54, B-66
LL3-DJ01	    	      	→ B-19
LL3-DJ02	    	      	→ B-20
LL3-DK04	    	      	→ B-26
LL3-DK06	    	      	→ B-20
LL3-DK21	    	      	→ B-20
LL3-DK33	    	      	→ B-32, B-46
LL3-DK43	    	      	→ B-46
LL3-DK4Z	    	      	→ B-26, B-73
LL3-DK63Z	    	      	→ B-46, B-73
LL3-DK66	    	      	→ B-20, B-73



































































































A

Type	Design	Application	Page
LL3-DK67			→ B-20, B-73
LL3-DM01			→ B-20
LL3-DM02			→ B-20
LL3-DM03			→ B-46
LL3-DP01			→ B-27
LL3-DR01			→ B-20, B-69, B-74
LL3-DR02			→ B-20, B-69, B-74
LL3-DR03			→ B-27, B-69, B-74
LL3-DR04			→ B-27, B-69, B-74
LL3-DR05			→ B-27, B-46, B-69
LL3-DR06			→ B-21, B-69, B-74
LL3-DR07			→ B-47
LL3-DR08			→ B-21, B-69
LL3-DR09			→ B-41, B-66, B-74
LL3-DR10			→ B-47
LL3-DR11			→ B-27
LL3-DR12			→ B-27, B-33, B-74
LL3-DS06			→ B-21
LL3-DT01			→ B-21
LL3-DT01-05			→ B-21
LL3-DT02			→ B-47, B-70, B-74
LL3-DT03			→ B-27
LL3-DT04			→ B-47, B-70, B-75
LL3-DT05			→ B-47
LL3-DV01			→ B-33, B-47
LL3-DV02			→ B-33, B-47
LL3-DV03			→ B-33, B-47

Type	Design					Application										Page
LL3-DV05	M6									100 °C						→ B-21, B-33
LL3-DV06	M6									105 °C						→ B-21, B-33, B-55
LL3-DV07	M6									100 °C						→ B-21, B-33, B-75
LL3-DW01	M6									200 °C						→ B-21, B-55, B-61
LL3-DW01-2	M6									200 °C						→ B-22, B-55, B-61
LL3-DW02	M3									100 °C						→ B-61
LL3-DY01	M3									100 °C						→ B-58
LL3-DZ01	M3									100 °C						→ B-50
LL3-DZ02	M3									100 °C						→ B-51
LL3-DZ03	M3									100 °C						→ B-51
LL3-LM31150	M3									100 °C						→ B-27
LL3-LM311500	M3									100 °C						→ B-28
LL3-LM31300	M3									100 °C						→ B-27
LL3-LM31450	M3									100 °C						→ B-28
LL3-LM31750	M3									100 °C						→ B-28
LL3-LM32750	M3									100 °C						→ B-28, B-30, B-61, B-63
LL3-LM35150	M3									100 °C						→ B-28
LL3-LM35450	M3									100 °C						→ B-28
LL3-LM35750	M3									100 °C						→ B-28
LL3-LM361000	M3									100 °C						→ B-33
LL3-LM361250	M3									100 °C						→ B-33
LL3-LM36150	M3									100 °C						→ B-34
LL3-LM36450	M3									100 °C						→ B-34
LL3-LM36750	M3									100 °C						→ B-34
LL3-LM37150	M3									100 °C						→ B-34
LL3-LM37450	M3									100 °C						→ B-34
LL3-LM37750	M3									100 °C						→ B-34

A

Type	Design	Application	Page
LL3-LM38750	    	  100°C     	→ B-34, B-35, B-61, B-63
LL3-LM38751	    	  100°C     	→ B-34, B-35, B-61, B-63
LL3-LM39750	    	  100°C     	→ B-34, B-35, B-62, B-63
LL3-LM401000	    	  100°C     	→ B-28
LL3-LT312200	    	  100°C     	→ B-30
LL3-LT31450	    	  100°C     	→ B-28
LL3-LT31750	    	  100°C     	→ B-29
LL3-RR01	    	  100°C     	→ B-42, B-75



Fiber-optic through-beam systems

A

Type	Design	Application	Page
LL3-DC57			→ B-43, B-76
LL3-LM32450			→ B-30
LL3-LM32750			→ B-28, B-30, B-61, B-63
LL3-LM38150			→ B-35
LL3-LM38450			→ B-35
LL3-LM38750			→ B-34, B-35, B-61, B-63
LL3-LM38751			→ B-34, B-35, B-61, B-63
LL3-LM39450			→ B-35
LL3-LM39750			→ B-34, B-35, B-62, B-63
LL3-TB01			→ B-23
LL3-TB01-10			→ B-23
LL3-TB01-30			→ B-23
LL3-TB02			→ B-23
LL3-TB03			→ B-48
LL3-TB05			→ B-48
LL3-TB06			→ B-36
LL3-TB07			→ B-30
LL3-TE01			→ B-43, B-76
LL3-TE02			→ B-43, B-76
LL3-TE03			→ B-43, B-76
LL3-TE04			→ B-43, B-76
LL3-TE05			→ B-43, B-76
LL3-TF01			→ B-63
LL3-TG01			→ B-67
LL3-TG02			→ B-36, B-67, B-76





























































































































































# Selection guide THROUGH-BEAM SYSTEMS

# A

Type	Design	Application	Page
LL3-TG03		100°C	→ B-67
LL3-TG04		100°C	→ B-67, B-76
LL3-TG05		100°C	→ B-30, B-36, B-77
LL3-TH01		100°C	→ B-23, B-56
LL3-TH02		180°C	→ B-23, B-56
LL3-TH06		100°C	→ B-30, B-36
LL3-TH07		200°C	→ B-36, B-56
LL3-TH08		350°C	→ B-56
LL3-TH09		350°C	→ B-56
LL3-TH10		200°C	→ B-56
LL3-TH11		200°C	→ B-56
LL3-TH12		200°C	→ B-57
LL3-TH13		200°C	→ B-57
LL3-TH14		200°C	→ B-57
LL3-TH15		200°C	→ B-36, B-57
LL3-TH16		200°C	→ B-36, B-57
LL3-TJ01		100°C	→ B-23
LL3-TK05		100°C	→ B-30, B-77
LL3-TK16		100°C	→ B-36, B-48
LL3-TK77		100°C	→ B-24, B-77
LL3-TM01		100°C	→ B-24
LL3-TM02		100°C	→ B-24
LL3-TM03		100°C	→ B-30
LL3-TP01		100°C	→ B-48, B-77
LL3-TR01		100°C	→ B-24, B-71, B-77
LL3-TR01-05		100°C	→ B-24, B-71, B-77
LL3-TR02		100°C	→ B-24, B-71, B-77

Type	Design					Application								Page	
LL3-TR03	M3														→ B-24, B-71, B-77
LL3-TR03-2	M3														→ B-31, B-71, B-77
LL3-TR04	M3														→ B-31, B-71, B-78
LL3-TR05	M3														→ B-44, B-71, B-78
LL3-TR06	M3														→ B-44, B-71, B-78
LL3-TR08	M3														→ B-37, B-67, B-78
LL3-TR09	M3														→ B-37, B-67, B-78
LL3-TR10	M3														→ B-31, B-78
LL3-TR11	M3														→ B-44, B-78
LL3-TR12	M3														→ B-44, B-78
LL3-TR13	M3														→ B-44, B-78
LL3-TS07	M3														→ B-31
LL3-TS08	M3														→ B-37, B-48
LL3-TS10	M3														→ B-52
LL3-TS12	M3														→ B-37, B-48
LL3-TS14	M3														→ B-52
LL3-TS22	M3														→ B-37, B-67
LL3-TS22M	M3														→ B-37, B-57, B-67
LL3-TS40	M3														→ B-52, B-79
LL3-TT01	M3														→ B-48
LL3-TV01	M3														→ B-37, B-48
LL3-TV02	M3														→ B-37, B-49
LL3-TV04	M3														→ B-37, B-49
LL3-TV05	M4														→ B-24, B-38
LL3-TV06	M4														→ B-24, B-38, B-57
LL3-TV07	M4														→ B-25, B-38, B-79
LL3-TV08	M3														→ B-31, B-38

A

Type	Design	Application	Page
LL3-TV77	    	 100 °C      	→ B-25, B-38, B-79
LL3-TW01	    	 200 °C      	→ B-25, B-57, B-63
LL3-TW01-2	    	 200 °C      	→ B-25, B-57, B-63
LL3-TX01	    	 100 °C      	→ B-25
LL3-TX02	    	 100 °C      	→ B-25
LL3-TY01	    	 100 °C      	→ B-59
LL3-TY02	    	 100 °C      	→ B-38, B-59
LL3-TY03	    	 100 °C      	→ B-38, B-59
LL3-TY05	    	 100 °C      	→ B-59
LL3-TZ05	    	 100 °C      	→ B-52
LL3-TZ06	    	 100 °C      	→ B-52
LL3-TZ09	    	 100 °C      	→ B-52, B-79
LL3-TZ10	    	 100 °C      	→ B-52

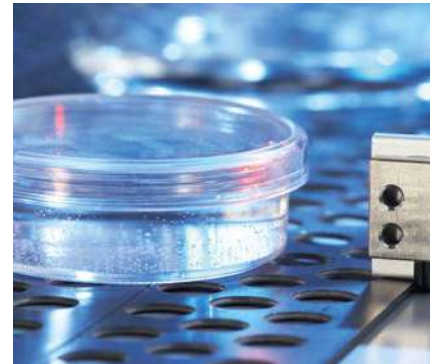




B



## FIBERS

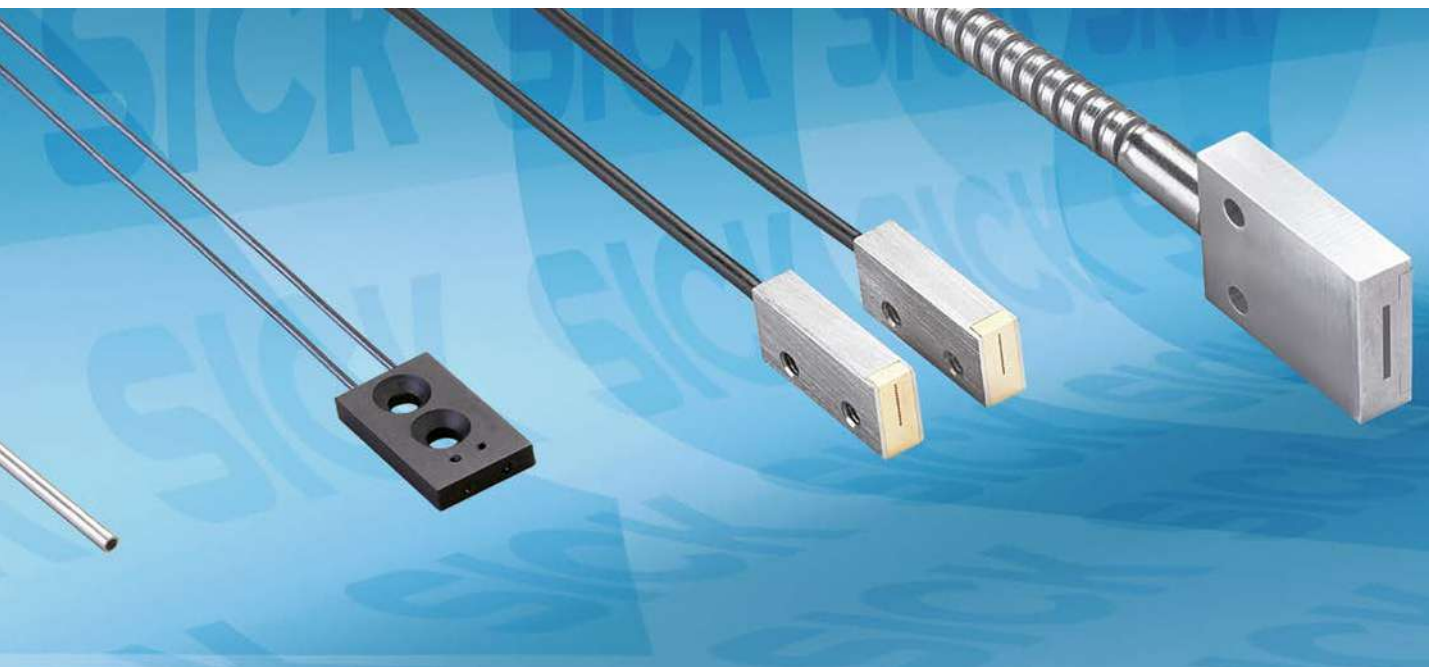


### Fit flexibly into the narrowest corners

When installation space is extremely limited or the objects to be detected are tiny, fiber-optic sensors are the ideal solution. If it is necessary for even higher requirements to be fulfilled, such as sensing range, temperature resistance, material durability or a flexible mounting process, the intelligent combination of sensors and fibers can provide the perfect solution. A wide range of fibers with application-specific optical heads ensure that every need is met.

### Your benefits

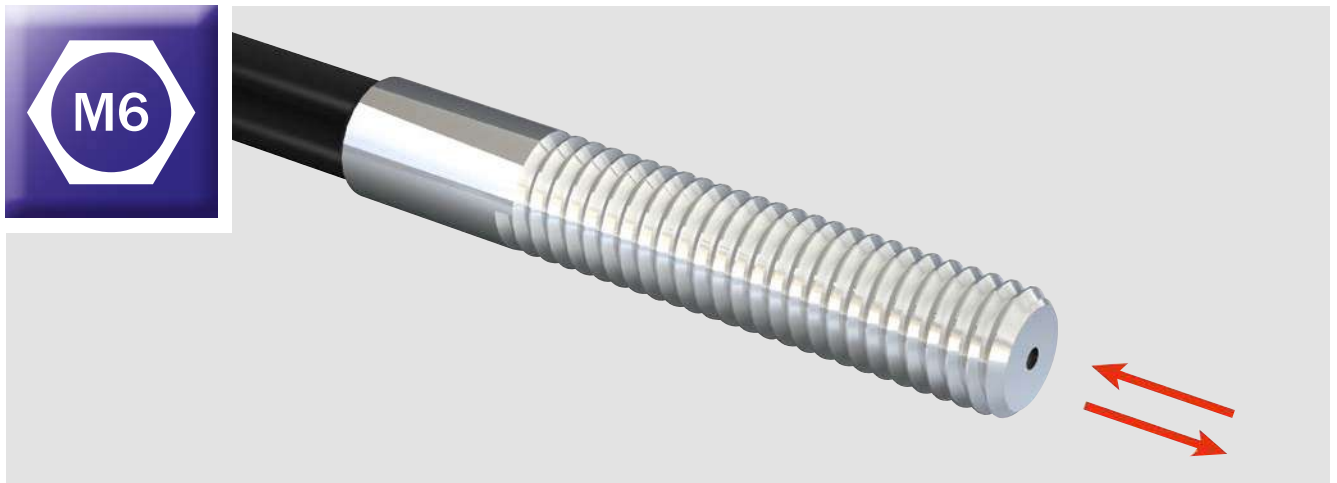
- Reliable and accurate detection of the smallest objects thanks to innovative, microcontroller-supported electronics
- EMC, high temperature tolerance and resistance to chemicals, as the evaluation electronics are mounted separately from the fiber-optic head
- Space-saving mounting even in confined spaces
- Multiple setting options provide solutions for practically any application
- Lightweight, suitable for use on a robot arm
- Universal application possibilities due to wide range of fibers



B

Design	Application
 Threaded sleeve. . . . . B-18	 Area detection. . . . . B-50
 Smooth sleeve. . . . . B-26	 Heat-resistant. . . . . B-53
 90° deflection. . . . . B-32	 Oil/chemical resistant . . . . . B-58
 Flat design. . . . . B-39	 Liquid level. . . . . B-60
 Long end sleeve. . . . . B-45	 LCDs/transparent objects . . . . . B-64
	 Robotics . . . . . B-68
	 Flexible fibers . . . . . B-72

B



Axial outlet



Fibers with hexagon head for space-saving installation

### Threaded sleeve

Fibers with thread are easy to mount, e.g., on a mounting bracket. An even greater sensing range can be achieved with a tip adapter, which can be optionally screwed on to some models.

The LL3-TV05/06/07 and LL3-DV05/06/07 90° models with hexagonal head, for example, are ideal for space-saving mounting. These are also available as highly-flexible and heat-resistant fibers.



### Threaded sleeve, proximity system

Figure	Length	Min. object diameter <sup>2)</sup>	Bend radius, fiber-optic cable	Ambient temperature, operation	Sensing range with GLL170 in mm		Sensing range with WLL180T in mm		Type	Part no.
	2 m <sup>1)</sup>	0.015 mm	25 mm	-40 °C ... +70 °C		160 <sup>8)</sup>		90 <sup>3)</sup>	LL3-DB01	5308074
						150 <sup>9)</sup>		280 <sup>4)</sup>		
						290 <sup>10)</sup>		500 <sup>5)</sup>		
						-		900 <sup>6)</sup>		
						-		1,350 <sup>7)</sup>		
	10 m <sup>1)</sup>	0.015 mm	25 mm	-40 °C ... +70 °C		100 <sup>8)</sup>		50 <sup>3)</sup>	LL3-DB01-10	5308075
						70 <sup>9)</sup>		140 <sup>4)</sup>		
						150 <sup>10)</sup>		250 <sup>5)</sup>		
						-		500 <sup>6)</sup>		
						-		750 <sup>7)</sup>		

<sup>1)</sup> FC fiber optic fiber cutter included in scope of delivery.

<sup>2)</sup> Minimum detectable object was determined at optimal measuring distance and optimal setting.




























































<sup>3)</sup> Operating mode: 16 µs. <sup>4)</sup> Operating mode: 70 µs. <sup>5)</sup> Operating mode: 250 µs. <sup>6)</sup> Operating mode: 2 ms. <sup>7)</sup> Operating mode: 8 ms.

<sup>8)</sup> Operating mode: 250 µs (potentiometer). <sup>9)</sup> Operating mode: 50 µs (teach-in). <sup>10)</sup> Operating mode: 250 µs (teach-in).

<sup>11)</sup> Humidity/level detection only in conjunction with WLL180T-P474 IR version.

Fiber optic cables with lengths different to the products shown here are available on request.

**B**

Figure	Length	Min. object diameter <sup>2)</sup>	Bend radius, fiber-optic cable	Ambient temperature, operation	Sensing range with GLL170 in mm		Sensing range with WLL180T in mm		Type	Part no.
	3 m <sup>1)</sup> 	0.015 mm	25 mm	-40 °C ... +70 °C	120 <sup>8)</sup>		90 <sup>3)</sup>	LL3-DB01-3	5322552	
					90 <sup>9)</sup>		280 <sup>4)</sup>			
					170 <sup>10)</sup>		500 <sup>5)</sup>			
					–		900 <sup>6)</sup>			
					–		1,350 <sup>7)</sup>			
Dimensional drawing → F-114										
	30 m <sup>1)</sup> 	0.015 mm	25 mm	-40 °C ... +70 °C	5 <sup>8)</sup>		35 <sup>3)</sup>	LL3-DB01-30	5324662	
					40 <sup>9)</sup>		98 <sup>4)</sup>			
					16 <sup>10)</sup>		175 <sup>5)</sup>			
					–		350 <sup>6)</sup>			
					–		525 <sup>7)</sup>			
Dimensional drawing → F-114										
	0.015 mm	25 mm	-40 °C ... +70 °C	-40 °C ... +70 °C	160 <sup>8)</sup>		90 <sup>3)</sup>	LL3-DB03	5313021	
					160 <sup>9)</sup>		300 <sup>4)</sup>			
					300 <sup>10)</sup>		500 <sup>5)</sup>			
					–		900 <sup>6)</sup>			
					–		1,350 <sup>7)</sup>			
Dimensional drawing → F-114										
	2 m <sup>1)</sup> 	0.015 mm	25 mm	-40 °C ... +70 °C	170 <sup>8)</sup>		90 <sup>3)</sup>	LL3-DB04	5325990	
					180 <sup>9)</sup>		280 <sup>4)</sup>			
					320 <sup>10)</sup>		500 <sup>5)</sup>			
					–		900 <sup>6)</sup>			
					–		1,350 <sup>7)</sup>			
Dimensional drawing → F-115										
	0.02 mm	25 mm	25 mm	-40 °C ... +60 °C	90 <sup>8)</sup>		27 <sup>3)</sup>	LL3-DB07	5325988	
					50 <sup>9)</sup>		88 <sup>4)</sup>			
					120 <sup>10)</sup>		165 <sup>5)</sup>			
					–		330 <sup>6)</sup>			
					–		350 <sup>7)</sup>			
Dimensional drawing → F-115										
	0.015 mm	35 mm	35 mm	-40 °C ... +180 °C	150 <sup>8)</sup>		120 <sup>3)</sup>	LL3-DH01	5308091	
					180 <sup>9)</sup>		350 <sup>4)</sup>			
					320 <sup>10)</sup>		600 <sup>5)</sup>			
					–		980 <sup>6)</sup>			
					–		1,500 <sup>7)</sup>			
Dimensional drawing → F-119										
	3 m <sup>1)</sup> 	0.015 mm	35 mm	-40 °C ... +180 °C	210 <sup>8)</sup>		100 <sup>3)</sup>	LL3-DH01-03	5321260	
					180 <sup>9)</sup>		300 <sup>4)</sup>			
					330 <sup>10)</sup>		500 <sup>5)</sup>			
					–		850 <sup>6)</sup>			
					–		1,400 <sup>7)</sup>			
Dimensional drawing → F-119										
	2 m <sup>1)</sup> 	0.015 mm	25 mm	-40 °C ... +100 °C	90 <sup>8)</sup>		70 <sup>3)</sup>	LL3-DH02	5308092	
					110 <sup>9)</sup>		230 <sup>4)</sup>			
					220 <sup>10)</sup>		350 <sup>5)</sup>			
					–		600 <sup>6)</sup>			
					–		1,000 <sup>7)</sup>			
Dimensional drawing → F-119										
	1 m	0.02 mm	10 mm	-40 °C ... +60 °C	70 <sup>8)</sup>		14 <sup>3)</sup>	LL3-DJ01	5325989	
					30 <sup>9)</sup>		49 <sup>4)</sup>			
					70 <sup>10)</sup>		99 <sup>5)</sup>			
					–		190 <sup>6)</sup>			
					–		210 <sup>7)</sup>			
Dimensional drawing → F-121										

<sup>1)</sup> FC fiber optic fiber cutter included in scope of delivery.

<sup>2)</sup> Minimum detectable object was determined at optimal measuring distance and optimal setting.

<sup>3)</sup> Operating mode: 16 µs. <sup>4)</sup> Operating mode: 70 µs. <sup>5)</sup> Operating mode: 250 µs. <sup>6)</sup> Operating mode: 2 ms. <sup>7)</sup> Operating mode: 8 ms.


















































































<sup>8)</sup> Operating mode: 250 µs (potentiometer). <sup>9)</sup> Operating mode: 50 µs (teach-in). <sup>10)</sup> Operating mode: 250 µs (teach-in).

<sup>11)</sup> Humidity/level detection only in conjunction with WLL180T-P474 IR version.

Fiber optic cables with lengths different to the products shown here are available on request.



B

Figure	Length	Min. object diameter <sup>2)</sup>	Bend radius, fiber-optic cable	Ambient temperature, operation	Sensing range with GLL170 in mm		Sensing range with WLL180T in mm		Type	Part no.
	1 m	0.02 mm	10 mm	-40 °C ... +70 °C	 150 <sup>8)</sup>	 38 <sup>3)</sup>	LL3-DJ02	5325992	Dimensional drawing → F-121	
					 80 <sup>9)</sup>	 120 <sup>4)</sup>				
					 160 <sup>10)</sup>	 230 <sup>5)</sup>				
					-	 460 <sup>6)</sup>				
					-	 490 <sup>7)</sup>				
	2 m <sup>1)</sup>	0.015 mm	15 mm	-40 °C ... +70 °C	 170 <sup>8)</sup>	 100 <sup>3)</sup>	LL3-DK06	5313019	Dimensional drawing → F-121	
					 180 <sup>9)</sup>	 300 <sup>4)</sup>				
					 310 <sup>10)</sup>	 500 <sup>5)</sup>				
					-	 900 <sup>6)</sup>				
					-	 1,400 <sup>7)</sup>				
 <p>Suitable for tip adapters</p>	500 mm	0.015 mm	15 mm	-40 °C ... +70 °C	 70 <sup>8)</sup>	 14 <sup>3)</sup>	LL3-DK21	5313023	Dimensional drawing → F-121	
					 20 <sup>9)</sup>	 45 <sup>4)</sup>				
					 40 <sup>10)</sup>	 75 <sup>5)</sup>				
					-	 135 <sup>6)</sup>				
					-	 200 <sup>7)</sup>				
	2 m <sup>1)</sup>	0.015 mm	2 mm	-40 °C ... +70 °C	 120 <sup>8)</sup>	 90 <sup>3)</sup>	LL3-DK66	5313024	Dimensional drawing → F-122	
					 160 <sup>9)</sup>	 300 <sup>4)</sup>				
					 290 <sup>10)</sup>	 500 <sup>5)</sup>				
					-	 900 <sup>6)</sup>				
					-	 1,400 <sup>7)</sup>				
	2 m <sup>1)</sup>	0.015 mm	2 mm	-40 °C ... +70 °C	 120 <sup>8)</sup>	 90 <sup>3)</sup>	LL3-DK67	5313025	Dimensional drawing → F-122	
					 160 <sup>9)</sup>	 300 <sup>4)</sup>				
					 290 <sup>10)</sup>	 500 <sup>5)</sup>				
					-	 900 <sup>6)</sup>				
					-	 1,400 <sup>7)</sup>				
	2 m <sup>1)</sup>	0.015 mm	25 mm	-40 °C ... +70 °C	 170 <sup>8)</sup>	 75 <sup>3)</sup>	LL3-DM01	5308071	Dimensional drawing → F-122	
					 130 <sup>9)</sup>	 255 <sup>4)</sup>				
					 240 <sup>10)</sup>	 420 <sup>5)</sup>				
					-	 800 <sup>6)</sup>				
					-	 1,300 <sup>7)</sup>				
 <p>Suitable for tip adapters</p>	2 m <sup>1)</sup>	0.015 mm	15 mm	-40 °C ... +70 °C	 70 <sup>8)</sup>	 40 <sup>3)</sup>	LL3-DM02	5308077	Dimensional drawing → F-122	
					 60 <sup>9)</sup>	 130 <sup>4)</sup>				
					 110 <sup>10)</sup>	 200 <sup>5)</sup>				
					-	 350 <sup>6)</sup>				
					-	 600 <sup>7)</sup>				
	2 m <sup>1)</sup>	0.015 mm	4 mm	-40 °C ... +70 °C	 140 <sup>8)</sup>	 90 <sup>3)</sup>	LL3-DR01	5308078	Dimensional drawing → F-123	
					 140 <sup>9)</sup>	 280 <sup>4)</sup>				
					 260 <sup>10)</sup>	 450 <sup>5)</sup>				
					-	 880 <sup>6)</sup>				
					-	 1,350 <sup>7)</sup>				
	1 m <sup>1)</sup>	0.015 mm	4 mm	-40 °C ... +70 °C	 30 <sup>8)</sup>	 18 <sup>3)</sup>	LL3-DR02	5308079	Dimensional drawing → F-123	
					 20 <sup>9)</sup>	 50 <sup>4)</sup>				
					 40 <sup>10)</sup>	 90 <sup>5)</sup>				
					-	 200 <sup>6)</sup>				
					-	 370 <sup>7)</sup>				

<sup>1)</sup> FC fiber optic fiber cutter included in scope of delivery.









































































<sup>2)</sup> Minimum detectable object was determined at optimal measuring distance and optimal setting.

<sup>3)</sup> Operating mode: 16 µs. <sup>4)</sup> Operating mode: 70 µs. <sup>5)</sup> Operating mode: 250 µs. <sup>6)</sup> Operating mode: 2 ms. <sup>7)</sup> Operating mode: 8 ms.

<sup>8)</sup> Operating mode: 250 µs (potentiometer). <sup>9)</sup> Operating mode: 50 µs (teach-in). <sup>10)</sup> Operating mode: 250 µs (teach-in).

<sup>11)</sup> Humidity/level detection only in conjunction with WLL180T-P474 IR version.

Fiber optic cables with lengths different to the products shown here are available on request.

Figure	Length	Min. object diameter <sup>2)</sup>	Bend radius, fiber-optic cable	Ambient temperature, operation	Sensing range with GLL170 in mm		Sensing range with WLL180T in mm		Type	Part no.
	2 m <sup>1)</sup>	0.015 mm	4 mm	-40 °C ... +70 °C	 40 <sup>8)</sup>	 18 <sup>3)</sup>	LL3-DR06	5308082		
					 30 <sup>9)</sup>	 60 <sup>4)</sup>				
					 60 <sup>10)</sup>	 100 <sup>5)</sup>				
					-	 220 <sup>6)</sup>				
Dimensional drawing → F-123										
	2 m <sup>1)</sup>	0.02 mm	4 mm	-40 °C ... +70 °C	 30 <sup>8)</sup>	 8 <sup>3)</sup>	LL3-DR08	5326037		
					 10 <sup>9)</sup>	 25 <sup>4)</sup>				
					 30 <sup>10)</sup>	 46 <sup>5)</sup>				
					-	 90 <sup>6)</sup>				
Dimensional drawing → F-124										
	2 m <sup>1)</sup>	0.015 mm	15 mm	-40 °C ... +70 °C	 60 <sup>8)</sup>	 18 <sup>3)</sup>	LL3-DS06	5308073		
					 50 <sup>9)</sup>	 55 <sup>4)</sup>				
					 90 <sup>10)</sup>	 95 <sup>5)</sup>				
					-	 190 <sup>6)</sup>				
Dimensional drawing → F-124										
	2 m <sup>1)</sup>	0.015 mm	15 mm	-40 °C ... +70 °C	 70 <sup>8)</sup>	 40 <sup>3)</sup>	LL3-DT01	5308076		
					 60 <sup>9)</sup>	 130 <sup>4)</sup>				
					 110 <sup>10)</sup>	 200 <sup>5)</sup>				
					-	 350 <sup>6)</sup>				
Dimensional drawing → F-125										
	5 m <sup>1)</sup>	0.015 mm	15 mm	-40 °C ... +70 °C	 60 <sup>8)</sup>	 30 <sup>3)</sup>	LL3-DT01-05	5309087		
					 50 <sup>9)</sup>	 100 <sup>4)</sup>				
					 90 <sup>10)</sup>	 150 <sup>5)</sup>				
					-	 300 <sup>6)</sup>				
Dimensional drawing → F-125										
	2 m <sup>1)</sup>	0.015 mm	25 mm	-40 °C ... +70 °C	 50 <sup>8)</sup>	 25 <sup>3)</sup>	LL3-DV05	5322549		
					 60 <sup>9)</sup>	 110 <sup>4)</sup>				
					 100 <sup>10)</sup>	 185 <sup>5)</sup>				
					-	 400 <sup>6)</sup>				
Dimensional drawing → F-126										
	2 m <sup>1)</sup>	0.015 mm	25 mm	-40 °C ... +105 °C	 50 <sup>8)</sup>	 30 <sup>3)</sup>	LL3-DV06	5322550		
					 70 <sup>9)</sup>	 130 <sup>4)</sup>				
					 120 <sup>10)</sup>	 210 <sup>5)</sup>				
					-	 450 <sup>6)</sup>				
Dimensional drawing → F-126										
	2 m <sup>1)</sup>	0.015 mm	2 mm	-40 °C ... +70 °C	 60 <sup>8)</sup>	 20 <sup>3)</sup>	LL3-DV07	5322551		
					 60 <sup>9)</sup>	 110 <sup>4)</sup>				
					 100 <sup>10)</sup>	 180 <sup>5)</sup>				
					-	 400 <sup>6)</sup>				
Dimensional drawing → F-126										
	1 m	0.02 mm	25 mm	-40 °C ... +210 °C	 142 <sup>8)</sup>	 20 <sup>3)</sup>	LL3-DW01 <sup>11)</sup>	5315234		
					 206 <sup>9)</sup>	 50 <sup>4)</sup>				
					 323 <sup>10)</sup>	 95 <sup>5)</sup>				
					-	 150 <sup>6)</sup>				
Dimensional drawing → F-126										

<sup>1)</sup> FC fiber optic fiber cutter included in scope of delivery.

<sup>2)</sup> Minimum detectable object was determined at optimal measuring distance and optimal setting.










<sup>3)</sup> Operating mode: 16 µs. <sup>4)</sup> Operating mode: 70 µs. <sup>5)</sup> Operating mode: 250 µs. <sup>6)</sup> Operating mode: 2 ms. <sup>7)</sup> Operating mode: 8 ms.

<sup>8)</sup> Operating mode: 250 µs (potentiometer). <sup>9)</sup> Operating mode: 50 µs (teach-in). <sup>10)</sup> Operating mode: 250 µs (teach-in).

<sup>11)</sup> Humidity/level detection only in conjunction with WLL180T-P474 IR version.

Fiber optic cables with lengths different to the products shown here are available on request.



Figure	Length	Min. object diameter <sup>2)</sup>	Bend radius, fiber-optic cable	Ambient temperature, operation	Sensing range with GLL170 in mm		Sensing range with WLL180T in mm		Type	Part no.
	2 m	0.02 mm	25 mm	-40 °C ... +210 °C	 153 <sup>8)</sup>	 20 <sup>3)</sup>	LL3-DW01-2 <sup>11)</sup>	5324789		
					 230 <sup>9)</sup>	 50 <sup>4)</sup>				
					 352 <sup>10)</sup>	 95 <sup>5)</sup>				
					-	 150 <sup>6)</sup>				
					-	 400 <sup>7)</sup>				
Dimensional drawing → <a href="#">F-127</a>										

<sup>1)</sup> FC fiber optic fiber cutter included in scope of delivery.

<sup>2)</sup> Minimum detectable object was determined at optimal measuring distance and optimal setting.

<sup>3)</sup> Operating mode: 16 µs. <sup>4)</sup> Operating mode: 70 µs. <sup>5)</sup> Operating mode: 250 µs. <sup>6)</sup> Operating mode: 2 ms. <sup>7)</sup> Operating mode: 8 ms.

<sup>8)</sup> Operating mode: 250 µs (potentiometer). <sup>9)</sup> Operating mode: 50 µs (teach-in). <sup>10)</sup> Operating mode: 250 µs (teach-in).














































































<sup>11)</sup> Humidity/level detection only in conjunction with WLL180T-P474 IR version.

Fiber optic cables with lengths different to the products shown here are available on request.

B



Threaded sleeve, through-beam system

Figure	Length	Min. object diameter <sup>2)</sup>	Bend radius, fiber-optic cable	Ambient temperature, operation	Sensing range with GLL170 in mm		Sensing range with WLL180T in mm		Type	Part no.
  Suitable for tip adapters	2 m <sup>1)</sup> 	0.5 mm	30 mm	-40 °C ... +70 °C	 830 <sup>8)</sup>	 300 <sup>3)</sup>	LL3-TB01	5308050		
					 770 <sup>9)</sup>	 950 <sup>4)</sup>				
					 1,220 <sup>10)</sup>	 1,700 <sup>5)</sup>				
					-	 3,500 <sup>6)</sup>				
					-	 4,000 <sup>7)</sup>				
Dimensional drawing → F-135										
  Suitable for tip adapters	10 m <sup>1)</sup> 	0.5 mm	30 mm	-40 °C ... +70 °C	 490 <sup>8)</sup>	 230 <sup>3)</sup>	LL3-TB01-10	5308051		
					 550 <sup>9)</sup>	 650 <sup>4)</sup>				
					 880 <sup>10)</sup>	 1,200 <sup>5)</sup>				
					-	 2,450 <sup>6)</sup>				
					-	 4,000 <sup>7)</sup>				
Dimensional drawing → F-135										
  Suitable for tip adapters	30 m <sup>1)</sup> 	0.5 mm	30 mm	-40 °C ... +70 °C	 5 <sup>8)</sup>	 160 <sup>3)</sup>	LL3-TB01-30	5315499		
					 40 <sup>9)</sup>	 450 <sup>4)</sup>				
					 16 <sup>10)</sup>	 840 <sup>5)</sup>				
					-	 1,700 <sup>6)</sup>				
					-	 2,800 <sup>7)</sup>				
Dimensional drawing → F-135										
  Suitable for tip adapters	2 m <sup>1)</sup> 	0.2 mm	25 mm	-40 °C ... +70 °C	 610 <sup>8)</sup>	 225 <sup>3)</sup>	LL3-TB02	5308048		
					 550 <sup>9)</sup>	 650 <sup>4)</sup>				
					 890 <sup>10)</sup>	 1,200 <sup>5)</sup>				
					-	 2,500 <sup>6)</sup>				
					-	 4,000 <sup>7)</sup>				
Dimensional drawing → F-136										
   Suitable for tip adapters	2 m <sup>1)</sup> 	0.2 mm	25 mm	-40 °C ... +100 °C	 410 <sup>8)</sup>	 55 <sup>3)</sup>	LL3-TH01	5308064		
					 340 <sup>9)</sup>	 180 <sup>4)</sup>				
					 580 <sup>10)</sup>	 320 <sup>5)</sup>				
					-	 680 <sup>6)</sup>				
					-	 1,000 <sup>7)</sup>				
Dimensional drawing → F-138										
  	0.5 mm	35 mm	-40 °C ... +180 °C	-40 °C ... +180 °C	 460 <sup>8)</sup>	 230 <sup>3)</sup>	LL3-TH02	5308065		
					 460 <sup>9)</sup>	 700 <sup>4)</sup>				
					 780 <sup>10)</sup>	 1,300 <sup>5)</sup>				
					-	 2,700 <sup>6)</sup>				
					-	 4,000 <sup>7)</sup>				
Dimensional drawing → F-138										
 	1 m	0.05 mm	10 mm	-40 °C ... +60 °C	 540 <sup>8)</sup>	 145 <sup>3)</sup>	LL3-TJ01	5325915		
					 450 <sup>9)</sup>	 460 <sup>4)</sup>				
					 710 <sup>10)</sup>	 830 <sup>5)</sup>				
					-	 1,600 <sup>6)</sup>				
					-	 1,770 <sup>7)</sup>				
Dimensional drawing → F-140										

<sup>1)</sup> FC fiber optic fiber cutter included in scope of delivery.

<sup>2)</sup> Minimum detectable object was determined at optimal measuring distance and optimal setting.

<sup>3)</sup> Operating mode: 16 µs. <sup>4)</sup> Operating mode: 70 µs. <sup>5)</sup> Operating mode: 250 µs. <sup>6)</sup> Operating mode: 2 ms. <sup>7)</sup> Operating mode: 8 ms.































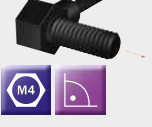









<sup>8)</sup> Operating mode: 250 µs (potentiometer). <sup>9)</sup> Operating mode: 50 µs (teach-in). <sup>10)</sup> Operating mode: 250 µs (teach-in).

<sup>11)</sup> Humidity/level detection only in conjunction with WLL180T-P474 IR version.

Fiber optic cables with lengths different to the products shown here are available on request.

**B**

B

Figure	Length	Min. object diameter <sup>2)</sup>	Bend radius, fiber-optic cable	Ambient temperature, operation	Sensing range with GLL170 in mm		Sensing range with WLL180T in mm		Type	Part no.
 Suitable for tip adapters	2 m <sup>1)</sup>	0.2 mm	2 mm	-40 °C ... +70 °C	 420 <sup>8)</sup>	 220 <sup>3)</sup>	LL3-TK77	5313035		
					 450 <sup>9)</sup>	 650 <sup>4)</sup>				
 Suitable for tip adapters	2 m <sup>1)</sup>	0.2 mm	25 mm	-40 °C ... +70 °C	 550 <sup>8)</sup>	 220 <sup>3)</sup>	LL3-TM01	5308068		
					 550 <sup>9)</sup>	 680 <sup>4)</sup>				
 Suitable for tip adapters	2 m <sup>1)</sup>	0.1 mm	15 mm	-40 °C ... +70 °C	 150 <sup>8)</sup>	 55 <sup>3)</sup>	LL3-TM02	5308069		
					 140 <sup>9)</sup>	 175 <sup>4)</sup>				
 Suitable for tip adapters	5 m <sup>1)</sup>	0.3 mm	4 mm	-40 °C ... +70 °C	 470 <sup>8)</sup>	 200 <sup>3)</sup>	LL3-TR01	5308052		
					 380 <sup>9)</sup>	 600 <sup>4)</sup>				
 Suitable for tip adapters	5 m <sup>1)</sup>	0.3 mm	4 mm	-40 °C ... +70 °C	 680 <sup>10)</sup>	 1,000 <sup>5)</sup>	LL3-TR01-05	5322198		
					 470 <sup>8)</sup>	 200 <sup>3)</sup>				
 Suitable for tip adapters	2 m <sup>1)</sup>	0.1 mm	4 mm	-40 °C ... +70 °C	 130 <sup>8)</sup>	 60 <sup>3)</sup>	LL3-TR02	5308053		
					 100 <sup>9)</sup>	 175 <sup>4)</sup>				
 Suitable for tip adapters	2 m <sup>1)</sup>	0.4 mm	25 mm	-40 °C ... +70 °C	 640 <sup>8)</sup>	 350 <sup>3)</sup>	LL3-TV05	5322546		
					 620 <sup>9)</sup>	 750 <sup>4)</sup>				
 Suitable for tip adapters	2 m <sup>1)</sup>	0.4 mm	25 mm	-40 °C ... +105 °C	 1,410 <sup>10)</sup>	 1,800 <sup>5)</sup>	LL3-TV06	5322547		
					 560 <sup>8)</sup>	 180 <sup>3)</sup>				

<sup>1)</sup> FC fiber optic fiber cutter included in scope of delivery.



















































<sup>2)</sup> Minimum detectable object was determined at optimal measuring distance and optimal setting.

<sup>3)</sup> Operating mode: 16 µs. <sup>4)</sup> Operating mode: 70 µs. <sup>5)</sup> Operating mode: 250 µs. <sup>6)</sup> Operating mode: 2 ms. <sup>7)</sup> Operating mode: 8 ms.

<sup>8)</sup> Operating mode: 250 µs (potentiometer). <sup>9)</sup> Operating mode: 50 µs (teach-in). <sup>10)</sup> Operating mode: 250 µs (teach-in).

<sup>11)</sup> Humidity/level detection only in conjunction with WLL180T-P474 IR version.

Fiber optic cables with lengths different to the products shown here are available on request.

Figure	Length	Min. object diameter <sup>2)</sup>	Bend radius, fiber-optic cable	Ambient temperature, operation	Sensing range with GLL170 in mm		Sensing range with WLL180T in mm		Type	Part no.
	2 m <sup>1)</sup>	0.4 mm	2 mm	-40 °C ... +70 °C	 460 <sup>8)</sup>	 340 <sup>3)</sup>	LL3-TV07	5322548		
					 840 <sup>9)</sup>	 1,000 <sup>4)</sup>				
					 1,290 <sup>10)</sup>	 1,800 <sup>5)</sup>				
					-	 4,000 <sup>6)</sup>				
		0.4 mm	2 mm	-40 °C ... +70 °C	 200 <sup>8)</sup>	 340 <sup>3)</sup>	LL3-TV77	5326557		
					 640 <sup>9)</sup>	 1,000 <sup>4)</sup>				
					 1,068 <sup>10)</sup>	 1,800 <sup>5)</sup>				
					-	 4,000 <sup>6)</sup>				
	1 m	0.4 mm	25 mm	-40 °C ... +210 °C	 556 <sup>8)</sup>	 80 <sup>3)</sup>	LL3-TW01 <sup>11)</sup>	5315233		
					 866 <sup>9)</sup>	 230 <sup>4)</sup>				
					 1,435 <sup>10)</sup>	 350 <sup>5)</sup>				
					-	 560 <sup>6)</sup>				
	2 m	0.4 mm	25 mm	-40 °C ... +210 °C	 534 <sup>8)</sup>	 80 <sup>3)</sup>	LL3-TW01-2 <sup>11)</sup>	5321306		
					 821 <sup>9)</sup>	 230 <sup>4)</sup>				
					 1,393 <sup>10)</sup>	 350 <sup>5)</sup>				
					-	 560 <sup>6)</sup>				
	20 m <sup>1)</sup>	0.5 mm	25 mm	-40 °C ... +60 °C	 2,700 <sup>8)</sup>	 1,000 <sup>3)</sup>	LL3-TX01	5324173		
					 6,890 <sup>9)</sup>	 3,700 <sup>4)</sup>				
					 10,810 <sup>10)</sup>	 7,000 <sup>5)</sup>				
					-	 14,000 <sup>6)</sup>				
		0.5 mm	25 mm	-40 °C ... +60 °C	 2,700 <sup>8)</sup>	 2,000 <sup>3)</sup>	LL3-TX02	5325046		
					 6,890 <sup>9)</sup>	 7,500 <sup>4)</sup>				
					 10,810 <sup>10)</sup>	 13,500 <sup>5)</sup>				
					-	 27,000 <sup>6)</sup>				

<sup>1)</sup> FC fiber optic fiber cutter included in scope of delivery.

<sup>2)</sup> Minimum detectable object was determined at optimal measuring distance and optimal setting.

<sup>3)</sup> Operating mode: 16 µs. <sup>4)</sup> Operating mode: 70 µs. <sup>5)</sup> Operating mode: 250 µs. <sup>6)</sup> Operating mode: 2 ms. <sup>7)</sup> Operating mode: 8 ms.

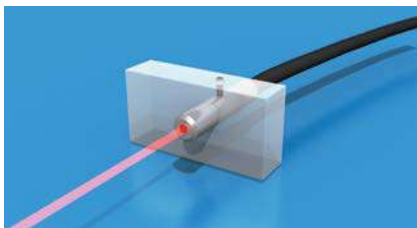
<sup>8)</sup> Operating mode: 250 µs (potentiometer). <sup>9)</sup> Operating mode: 50 µs (teach-in). <sup>10)</sup> Operating mode: 250 µs (teach-in).

<sup>11)</sup> Humidity/level detection only in conjunction with WLL180T-P474 IR version.

Fiber optic cables with lengths different to the products shown here are available on request.

B

B



Easy to mount with setscrew

### Smooth sleeve

Cylindrical fibers are ideal for space-saving mounting. This is carried out by simply securing it with a setscrew.



### Smooth sleeve, proximity system

Figure	Length	Min. object diameter <sup>2)</sup>	Bend radius, fiber-optic cable	Ambient temperature, operation	Sensing range with GLL170 in mm		Sensing range with WLL180T in mm		Type	Part no.
		0.02 mm	25 mm	-40 °C ... +70 °C		240 <sup>8)</sup>		70 <sup>3)</sup>	LL3-DB10	5325999
						140 <sup>9)</sup>		220 <sup>4)</sup>		
						260 <sup>10)</sup>		360 <sup>5)</sup>		
						-		720 <sup>6)</sup>		
						-		770 <sup>7)</sup>		
	2 m <sup>1)</sup>	0.015 mm	25 mm	-40 °C ... +70 °C		170 <sup>8)</sup>		100 <sup>3)</sup>	LL3-DK04	5313020
						180 <sup>9)</sup>		300 <sup>4)</sup>		
						310 <sup>10)</sup>		500 <sup>5)</sup>		
						-		900 <sup>6)</sup>		
						-		1,400 <sup>7)</sup>		
		0.015 mm	2 mm	-40 °C ... +70 °C		120 <sup>8)</sup>		65 <sup>3)</sup>	LL3-DK4Z	5313026
						160 <sup>9)</sup>		200 <sup>4)</sup>		
						290 <sup>10)</sup>		350 <sup>5)</sup>		
						-		650 <sup>6)</sup>		
						-		1,000 <sup>7)</sup>		

<sup>1)</sup> FC fiber optic fiber cutter included in scope of delivery.

<sup>2)</sup> Minimum detectable object was determined at optimal measuring distance and optimal setting.

<sup>3)</sup> Operating mode: 16 µs. <sup>4)</sup> Operating mode: 70 µs. <sup>5)</sup> Operating mode: 250 µs. <sup>6)</sup> Operating mode: 2 ms. <sup>7)</sup> Operating mode: 8 ms.

<sup>8)</sup> Operating mode: 250 µs (potentiometer). <sup>9)</sup> Operating mode: 50 µs (teach-in). <sup>10)</sup> Operating mode: 250 µs (teach-in).

Fiber optic cables with lengths different to the products shown here are available on request.

Figure	Length	Min. object diameter <sup>2)</sup>	Bend radius, fiber-optic cable	Ambient temperature, operation	Sensing range with GLL170 in mm		Sensing range with WLL180T in mm		Type	Part no.
	1 m	0.02 mm	10 mm	-40 °C ... +60 °C	4 <sup>8)</sup>	-	-	LL3-DP01	5325998	
					2 <sup>9)</sup>	3 <sup>4)</sup>				
					11 <sup>10)</sup>	14 <sup>5)</sup>				
					-	29 <sup>6)</sup>				
					-	31 <sup>7)</sup>				
Dimensional drawing → F-123										
	2 m <sup>1)</sup>	0.015 mm	4 mm	-40 °C ... +70 °C	40 <sup>8)</sup>	30 <sup>3)</sup>	LL3-DR03	5308080		
					40 <sup>9)</sup>	85 <sup>4)</sup>				
					80 <sup>10)</sup>	140 <sup>5)</sup>				
					-	300 <sup>6)</sup>				
					-	600 <sup>7)</sup>				
Dimensional drawing → F-123										
	1 m	0.015 mm	4 mm	-40 °C ... +70 °C	20 <sup>7)</sup>	20 <sup>3)</sup>	LL3-DR04	5308081		
					30 <sup>8)</sup>	70 <sup>4)</sup>				
					60 <sup>9)</sup>	110 <sup>5)</sup>				
					-	220 <sup>6)</sup>				
					-	360 <sup>7)</sup>				
Dimensional drawing → F-123										
	500 mm	0.015 mm	4 mm	-40 °C ... +70 °C	10 <sup>8)</sup>	10 <sup>3)</sup>	LL3-DR05	5308087		
					10 <sup>9)</sup>	30 <sup>4)</sup>				
					30 <sup>10)</sup>	60 <sup>5)</sup>				
					-	140 <sup>6)</sup>				
					-	225 <sup>7)</sup>				
Dimensional drawing → F-123										
	2 m	0.02 mm	2 mm	-40 °C ... +60 °C	90 <sup>8)</sup>	22 <sup>3)</sup>	LL3-DR11	5326000		
					40 <sup>9)</sup>	74 <sup>4)</sup>				
					100 <sup>10)</sup>	140 <sup>5)</sup>				
					-	280 <sup>6)</sup>				
					-	300 <sup>7)</sup>				
Dimensional drawing → F-124										
	2 m <sup>1)</sup>	0.02 mm	1 mm	-40 °C ... +60 °C	10 <sup>8)</sup>	4 <sup>3)</sup>	LL3-DR12	5326001		
					0 <sup>9)</sup>	13 <sup>4)</sup>				
					20 <sup>10)</sup>	27 <sup>5)</sup>				
					-	55 <sup>6)</sup>				
					-	59 <sup>7)</sup>				
Dimensional drawing → F-124										
	2 m	0.015 mm	15 mm	-40 °C ... +70 °C	60 <sup>8)</sup>	18 <sup>3)</sup>	LL3-DT03	5308072		
					50 <sup>9)</sup>	55 <sup>4)</sup>				
					90 <sup>10)</sup>	95 <sup>5)</sup>				
					-	190 <sup>6)</sup>				
					-	360 <sup>7)</sup>				
Dimensional drawing → F-125										
	150 mm	0.5 mm	20 mm	-10 °C ... +60 °C	105 <sup>8)</sup>	60 <sup>3)</sup>	LL3-LM31150	2073483		
					185 <sup>9)</sup>	170 <sup>4)</sup>				
					279 <sup>10)</sup>	270 <sup>5)</sup>				
					-	370 <sup>6)</sup>				
					-	400 <sup>7)</sup>				
Dimensional drawing → F-128										
	300 mm	0.5 mm	20 mm	-10 °C ... +60 °C	95 <sup>8)</sup>	50 <sup>3)</sup>	LL3-LM31300	2079212		
					174 <sup>9)</sup>	140 <sup>4)</sup>				
					261 <sup>10)</sup>	210 <sup>5)</sup>				
					-	310 <sup>6)</sup>				
					-	340 <sup>7)</sup>				
Dimensional drawing → F-128										

<sup>1)</sup> FC fiber optic fiber cutter included in scope of delivery.
















































































<sup>2)</sup> Minimum detectable object was determined at optimal measuring distance and optimal setting.

<sup>3)</sup> Operating mode: 16 µs. <sup>4)</sup> Operating mode: 70 µs. <sup>5)</sup> Operating mode: 250 µs. <sup>6)</sup> Operating mode: 2 ms. <sup>7)</sup> Operating mode: 8 ms.

<sup>8)</sup> Operating mode: 250 µs (potentiometer). <sup>9)</sup> Operating mode: 50 µs (teach-in). <sup>10)</sup> Operating mode: 250 µs (teach-in).

Fiber optic cables with lengths different to the products shown here are available on request.

B

Figure	Length	Min. object diameter <sup>2)</sup>	Bend radius, fiber-optic cable	Ambient temperature, operation	Sensing range with GLL170 in mm		Sensing range with WLL180T in mm		Type	Part no.
	450 mm	0.5 mm	20 mm	-10 °C ... +60 °C	 93 <sup>8)</sup>	 50 <sup>3)</sup>	 168 <sup>9)</sup>	 140 <sup>4)</sup>	LL3-LM31450	2073484
					 254 <sup>10)</sup>	 240 <sup>5)</sup>	 300 <sup>6)</sup>			
					-	 310 <sup>7)</sup>				
					-					
					-					
									Dimensional drawing → F-128	
	750 mm	0.5 mm	20 mm	-10 °C ... +60 °C	 82 <sup>8)</sup>	 50 <sup>3)</sup>	 153 <sup>9)</sup>	 140 <sup>4)</sup>	LL3-LM31750	2073485
					 236 <sup>10)</sup>	 240 <sup>5)</sup>	 220 <sup>6)</sup>			
					-	 220 <sup>7)</sup>				
					-					
					-					
									Dimensional drawing → F-128	
	1.5 m	0.5 mm	20 mm	-10 °C ... +60 °C	 125 <sup>8)</sup>	 50 <sup>3)</sup>	 217 <sup>9)</sup>	 140 <sup>4)</sup>	LL3-LM311500	2073486
					 332 <sup>10)</sup>	 240 <sup>5)</sup>	 220 <sup>6)</sup>			
					-	 220 <sup>7)</sup>				
					-					
					-					
									Dimensional drawing → F-128	
	750 mm	0.5 mm	20 mm	-10 °C ... +60 °C	 285 <sup>8)</sup>	 170 <sup>3)</sup>	 485 <sup>9)</sup>	 520 <sup>4)</sup>	LL3-LM32750	2073500
					 811 <sup>10)</sup>	 580 <sup>5)</sup>	 580 <sup>6)</sup>			
					-	 580 <sup>7)</sup>				
					-					
					-					
									Dimensional drawing → F-128	
	150 mm	0.5 mm	20 mm	-10 °C ... +60 °C	 175 <sup>8)</sup>	 60 <sup>3)</sup>	 104 <sup>9)</sup>	 160 <sup>4)</sup>	LL3-LM35150	2073488
					 182 <sup>10)</sup>	 190 <sup>5)</sup>	 200 <sup>6)</sup>			
					-	 200 <sup>7)</sup>				
					-					
					-					
									Dimensional drawing → F-129	
	450 mm	0.5 mm	20 mm	-10 °C ... +60 °C	 105 <sup>8)</sup>	 50 <sup>3)</sup>	 54 <sup>9)</sup>	 160 <sup>4)</sup>	LL3-LM35450	2073489
					 96 <sup>10)</sup>	 190 <sup>5)</sup>	 200 <sup>6)</sup>			
					-	 200 <sup>7)</sup>				
					-					
					-					
									Dimensional drawing → F-129	
	750 mm	0.5 mm	20 mm	-10 °C ... +60 °C	 49 <sup>8)</sup>	 50 <sup>3)</sup>	 31 <sup>9)</sup>	 90 <sup>4)</sup>	LL3-LM35750	2073490
					 58 <sup>10)</sup>	 100 <sup>5)</sup>	 100 <sup>6)</sup>			
					-	 100 <sup>7)</sup>				
					-					
					-					
									Dimensional drawing → F-129	
	1 m	0.5 mm	20 mm	-10 °C ... +60 °C	 12 <sup>8)</sup>	 40 <sup>3)</sup>	 16 <sup>9)</sup>	 40 <sup>4)</sup>	LL3-LM401000	2082375
					 20 <sup>10)</sup>	-	-			
					-	-	-			
					-	-	-			
					-	-	-			
									Dimensional drawing → F-131	
	450 mm	0.5 mm	20 mm	-10 °C ... +60 °C	 93 <sup>8)</sup>	 50 <sup>3)</sup>	 165 <sup>9)</sup>	 140 <sup>4)</sup>	LL3-LT31450	2077269
					 254 <sup>10)</sup>	 240 <sup>5)</sup>	 300 <sup>6)</sup>			
					-	 300 <sup>6)</sup>				
					-					
					-	 310 <sup>7)</sup>				
									Dimensional drawing → F-131	

<sup>1)</sup> FC fiber optic fiber cutter included in scope of delivery.










<sup>2)</sup> Minimum detectable object was determined at optimal measuring distance and optimal setting.

<sup>3)</sup> Operating mode: 16 µs. <sup>4)</sup> Operating mode: 70 µs. <sup>5)</sup> Operating mode: 250 µs. <sup>6)</sup> Operating mode: 2 ms. <sup>7)</sup> Operating mode: 8 ms.

<sup>8)</sup> Operating mode: 250 µs (potentiometer). <sup>9)</sup> Operating mode: 50 µs (teach-in). <sup>10)</sup> Operating mode: 250 µs (teach-in).

Fiber optic cables with lengths different to the products shown here are available on request.



Figure	Length	Min. object diameter <sup>2)</sup>	Bend radius, fiber-optic cable	Ambient temperature, operation	Sensing range with GLL170 in mm		Sensing range with WLL180T in mm		Type	Part no.
	750 mm	0.5 mm	20 mm	-10 °C ... +60 °C	 86 <sup>8)</sup>	 50 <sup>3)</sup>	LL3-LT31750	2074450		
					 164 <sup>9)</sup>	 140 <sup>4)</sup>				
					 270 <sup>10)</sup>	 240 <sup>5)</sup>				
					-	 220 <sup>6)</sup>				
					-	 220 <sup>7)</sup>				
Dimensional drawing → <a href="#">F-131</a>										

<sup>1)</sup> FC fiber optic fiber cutter included in scope of delivery.

<sup>2)</sup> Minimum detectable object was determined at optimal measuring distance and optimal setting.

<sup>3)</sup> Operating mode: 16 µs. <sup>4)</sup> Operating mode: 70 µs. <sup>5)</sup> Operating mode: 250 µs. <sup>6)</sup> Operating mode: 2 ms. <sup>7)</sup> Operating mode: 8 ms.

<sup>8)</sup> Operating mode: 250 µs (potentiometer). <sup>9)</sup> Operating mode: 50 µs (teach-in). <sup>10)</sup> Operating mode: 250 µs (teach-in).

Fiber optic cables with lengths different to the products shown here are available on request.

**B**



Smooth sleeve, through-beam system

B

Figure	Length	Min. object diameter <sup>2)</sup>	Bend radius, fiber-optic cable	Ambient temperature, operation	Sensing range with GLL170 in mm		Sensing range with WLL180T in mm		Type	Part no.
	450 mm	0.5 mm	20 mm	-10 °C ... +60 °C		305 <sup>8)</sup>		200 <sup>3)</sup>	LL3-LM32450	2073499
						623 <sup>9)</sup>		550 <sup>4)</sup>		
						640 <sup>10)</sup>		580 <sup>5)</sup>		
					-	-		580 <sup>6)</sup>		
					-	-		580 <sup>7)</sup>		
Dimensional drawing → F-133										
	750 mm	0.5 mm	20 mm	-10 °C ... +60 °C		285 <sup>8)</sup>		170 <sup>3)</sup>	LL3-LM32750	2073500
						485 <sup>9)</sup>		520 <sup>4)</sup>		
						811 <sup>10)</sup>		580 <sup>5)</sup>		
					-	-		580 <sup>6)</sup>		
					-	-		580 <sup>7)</sup>		
Dimensional drawing → F-133										
	2.2 m	0.5 mm	20 mm	-10 °C ... +60 °C		90 <sup>8)</sup>		50 <sup>3)</sup>	LL3-LT312200	2073487
						157 <sup>9)</sup>		140 <sup>4)</sup>		
						248 <sup>10)</sup>		200 <sup>5)</sup>		
					-	-		220 <sup>6)</sup>		
					-	-		220 <sup>7)</sup>		
Dimensional drawing → F-131										
	2 m <sup>1)</sup>	0.03 mm	25 mm	-40 °C ... +70 °C		670 <sup>8)</sup>		180 <sup>3)</sup>	LL3-TB07	5325919
						530 <sup>9)</sup>		540 <sup>4)</sup>		
						760 <sup>10)</sup>		890 <sup>5)</sup>		
					-	-		1,700 <sup>6)</sup>		
					-	-		1,900 <sup>7)</sup>		
Dimensional drawing → F-136										
	2 m <sup>1)</sup>	0.02 mm	1 mm	-40 °C ... +60 °C		40 <sup>8)</sup>		13 <sup>3)</sup>	LL3-TG05	5325921
						30 <sup>9)</sup>		50 <sup>4)</sup>		
						60 <sup>10)</sup>		85 <sup>5)</sup>		
					-	-		170 <sup>6)</sup>		
					-	-		180 <sup>7)</sup>		
Dimensional drawing → F-137										
	1 m <sup>1)</sup>	1 mm	10 mm	-40 °C ... +105 °C		20 <sup>8)</sup>		6 <sup>3)</sup>	LL3-TH06	5325926
						10 <sup>9)</sup>		19 <sup>4)</sup>		
						20 <sup>10)</sup>		38 <sup>5)</sup>		
					-	-		74 <sup>6)</sup>		
					-	-		130 <sup>7)</sup>		
Dimensional drawing → F-138										
	2 m <sup>1)</sup>	0.2 mm	2 mm	-40 °C ... +70 °C		540 <sup>8)</sup>		220 <sup>3)</sup>	LL3-TK05	5313034
						450 <sup>9)</sup>		650 <sup>4)</sup>		
						760 <sup>10)</sup>		1,200 <sup>5)</sup>		
					-	-		2,750 <sup>6)</sup>		
					-	-		4,000 <sup>7)</sup>		
Dimensional drawing → F-140										
	2 m <sup>1)</sup>	0.1 mm	15 mm	-40 °C ... +70 °C		150 <sup>8)</sup>		55 <sup>3)</sup>	LL3-TM03	5308070
						140 <sup>9)</sup>		175 <sup>4)</sup>		
						230 <sup>10)</sup>		300 <sup>5)</sup>		
					-	-		700 <sup>6)</sup>		
					-	-		1,100 <sup>7)</sup>		
Dimensional drawing → F-140										

<sup>1)</sup> FC fiber optic fiber cutter included in scope of delivery.

<sup>2)</sup> Minimum detectable object was determined at optimal measuring distance and optimal setting.

<sup>3)</sup> Operating mode: 16 µs. <sup>4)</sup> Operating mode: 70 µs. <sup>5)</sup> Operating mode: 250 µs. <sup>6)</sup> Operating mode: 2 ms. <sup>7)</sup> Operating mode: 8 ms.

<sup>8)</sup> Operating mode: 250 µs (potentiometer). <sup>9)</sup> Operating mode: 50 µs (teach-in). <sup>10)</sup> Operating mode: 250 µs (teach-in).

Fiber optic cables with lengths different to the products shown here are available on request.

Figure	Length	Min. object diameter <sup>2)</sup>	Bend radius, fiber-optic cable	Ambient temperature, operation	Sensing range with GLL170 in mm		Sensing range with WLL180T in mm		Type	Part no.
	1 m <sup>1)</sup>	0.1 mm	4 mm	-40 °C ... +70 °C		140 <sup>8)</sup>		60 <sup>3)</sup>	LL3-TR03	5308054
						150 <sup>9)</sup>		175 <sup>4)</sup>		
						240 <sup>10)</sup>		330 <sup>5)</sup>		
					-	-		750 <sup>6)</sup>		
					-	-		1,100 <sup>7)</sup>		
Dimensional drawing → F-141										
	2 m <sup>1)</sup>	0.1 mm	4 mm	-40 °C ... +70 °C		140 <sup>8)</sup>		60 <sup>3)</sup>	LL3-TR03-2	5308055
						150 <sup>9)</sup>		175 <sup>4)</sup>		
						240 <sup>10)</sup>		330 <sup>5)</sup>		
					-	-		750 <sup>6)</sup>		
					-	-		1,100 <sup>7)</sup>		
Dimensional drawing → F-141										
	500 mm	0.02 mm	4 mm	-40 °C ... +60 °C		40 <sup>8)</sup>		5 <sup>3)</sup>	LL3-TR04	5325918
						20 <sup>9)</sup>		17 <sup>4)</sup>		
						50 <sup>10)</sup>		28 <sup>5)</sup>		
					-	-		56 <sup>6)</sup>		
					-	-		60 <sup>7)</sup>		
Dimensional drawing → F-141										
		0.02 mm	1 mm	-40 °C ... +60 °C		1,070 <sup>8)</sup>		380 <sup>3)</sup>	LL3-TR10	5325920
						1,200 <sup>9)</sup>		1,220 <sup>4)</sup>		
						1,750 <sup>10)</sup>		2,000 <sup>5)</sup>		
					-	-		4,000 <sup>6)</sup>		
					-	-		4,000 <sup>7)</sup>		
Dimensional drawing → F-142										
	2 m <sup>1)</sup>	0.5 mm	30 mm	-40 °C ... +70 °C		830 <sup>8)</sup>		275 <sup>3)</sup>	LL3-TS07	5308049
						820 <sup>9)</sup>		1,000 <sup>4)</sup>		
						1,330 <sup>10)</sup>		1,800 <sup>5)</sup>		
					-	-		3,500 <sup>6)</sup>		
					-	-		4,000 <sup>7)</sup>		
Dimensional drawing → F-143										
		0.05 mm	25 mm	-40 °C ... +60 °C		1,690 <sup>8)</sup>		590 <sup>3)</sup>	LL3-TV08	5325922
						1,760 <sup>9)</sup>		1,790 <sup>4)</sup>		
						2,060 <sup>10)</sup>		2,400 <sup>5)</sup>		
					-	-		4,000 <sup>6)</sup>		
					-	-		4,000 <sup>7)</sup>		
Dimensional drawing → F-145										

<sup>1)</sup> FC fiber optic fiber cutter included in scope of delivery.

<sup>2)</sup> Minimum detectable object was determined at optimal measuring distance and optimal setting.

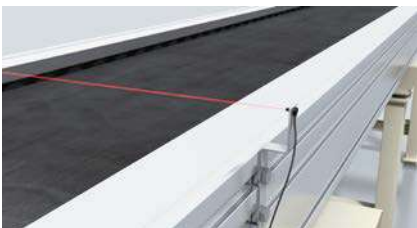
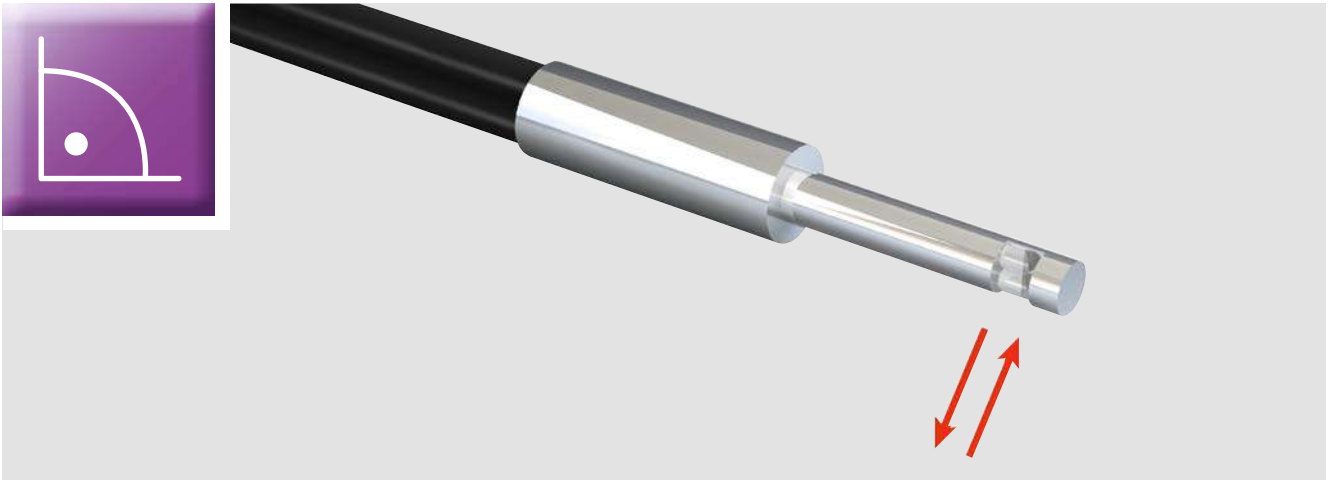
<sup>3)</sup> Operating mode: 16 µs. <sup>4)</sup> Operating mode: 70 µs. <sup>5)</sup> Operating mode: 250 µs. <sup>6)</sup> Operating mode: 2 ms. <sup>7)</sup> Operating mode: 8 ms.

<sup>8)</sup> Operating mode: 250 µs (potentiometer). <sup>9)</sup> Operating mode: 50 µs (teach-in). <sup>10)</sup> Operating mode: 250 µs (teach-in).

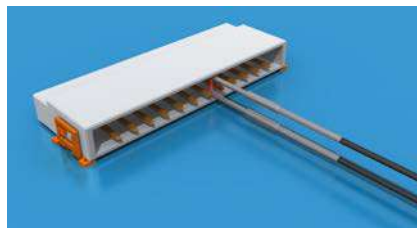
Fiber optic cables with lengths different to the products shown here are available on request.

**B**

B



Fibers with hexagon head for space-saving installation



The fiber-optic tip can be brought very close to the object

### 90° deflection

Fibers with integrated 90° deflection are the ideal solution for small installation depths and tight installation spaces. The fiber-optic cable can be installed close to the machine body to save space.



### 90° deflection, proximity system

Figure	Length	Min. object diameter <sup>2)</sup>	Bend radius, fiber-optic cable	Ambient temperature, operation	Sensing range with GLL170 in mm		Sensing range with WLL180T in mm		Type	Part no.
	2 m <sup>1)</sup>	0.02 mm	25 mm	-40 °C ... +70 °C		170 <sup>8)</sup>		47 <sup>3)</sup>	LL3-DB09	5325991
						110 <sup>9)</sup>		165 <sup>4)</sup>		
						200 <sup>10)</sup>		285 <sup>5)</sup>		
						-		575 <sup>6)</sup>		
						-		610 <sup>7)</sup>		
Dimensional drawing → <a href="#">F-115</a>										
	2 m <sup>1)</sup>	0.025 mm	25 mm	-40 °C ... +70 °C		100 <sup>8)</sup>		35 <sup>3)</sup>	LL3-DK33	5313031
						80 <sup>9)</sup>		135 <sup>4)</sup>		
						170 <sup>10)</sup>		170 <sup>5)</sup>		
						-		290 <sup>6)</sup>		
						-		320 <sup>7)</sup>		
Dimensional drawing → <a href="#">F-121</a>										

<sup>1)</sup> FC fiber optic fiber cutter included in scope of delivery.










<sup>2)</sup> Minimum detectable object was determined at optimal measuring distance and optimal setting.

<sup>3)</sup> Operating mode: 16 µs. <sup>4)</sup> Operating mode: 70 µs. <sup>5)</sup> Operating mode: 250 µs. <sup>6)</sup> Operating mode: 2 ms. <sup>7)</sup> Operating mode: 8 ms.

<sup>8)</sup> Operating mode: 250 µs (potentiometer). <sup>9)</sup> Operating mode: 50 µs (teach-in). <sup>10)</sup> Operating mode: 250 µs (teach-in).

Fiber optic cables with lengths different to the products shown here are available on request.

**B**

Figure	Length	Min. object diameter <sup>2)</sup>	Bend radius, fiber-optic cable	Ambient temperature, operation	Sensing range with GLL170 in mm		Sensing range with WLL180T in mm		Type	Part no.
		0.02 mm	1 mm	-40 °C ... +60 °C	■	10 <sup>8)</sup>	■	4 <sup>3)</sup>	LL3-DR12	5326001
					–	–	■	13 <sup>4)</sup>		
					■	20 <sup>10)</sup>	■	27 <sup>5)</sup>		
					–	–	■	55 <sup>6)</sup>		
Dimensional drawing → F-124										
		0.025 mm	25 mm	-40 °C ... +70 °C	■	150 <sup>8)</sup>	■	40 <sup>3)</sup>	LL3-DV01	5308088
					■	200 <sup>9)</sup>	■	135 <sup>4)</sup>		
					■	300 <sup>10)</sup>	■	180 <sup>5)</sup>		
					–	–	■	270 <sup>6)</sup>		
Dimensional drawing → F-126										
		0.015 mm	15 mm	-40 °C ... +70 °C	■	20 <sup>8)</sup>	■	10 <sup>3)</sup>	LL3-DV02	5308089
					■	20 <sup>9)</sup>	■	35 <sup>4)</sup>		
					■	40 <sup>10)</sup>	■	70 <sup>5)</sup>		
					–	–	■	125 <sup>6)</sup>		
Dimensional drawing → F-126										
	2 m <sup>1)</sup>	0.025 mm	25 mm	-40 °C ... +70 °C	■	100 <sup>8)</sup>	■	35 <sup>3)</sup>	LL3-DV03	5308090
					■	80 <sup>9)</sup>	■	135 <sup>4)</sup>		
					■	170 <sup>10)</sup>	■	170 <sup>5)</sup>		
					–	–	■	290 <sup>6)</sup>		
Dimensional drawing → F-126										
		0.015 mm	25 mm	-40 °C ... +70 °C	■	50 <sup>8)</sup>	■	25 <sup>3)</sup>	LL3-DV05	5322549
					■	60 <sup>9)</sup>	■	110 <sup>4)</sup>		
					■	100 <sup>10)</sup>	■	185 <sup>5)</sup>		
					–	–	■	400 <sup>6)</sup>		
Dimensional drawing → F-126										
		0.015 mm	25 mm	-40 °C ... +105 °C	■	50 <sup>8)</sup>	■	30 <sup>3)</sup>	LL3-DV06	5322550
					■	70 <sup>9)</sup>	■	130 <sup>4)</sup>		
					■	120 <sup>10)</sup>	■	210 <sup>5)</sup>		
					–	–	■	450 <sup>6)</sup>		
Dimensional drawing → F-126										
		0.015 mm	2 mm	-40 °C ... +70 °C	■	60 <sup>8)</sup>	■	20 <sup>3)</sup>	LL3-DV07	5322551
					■	60 <sup>9)</sup>	■	110 <sup>4)</sup>		
					■	100 <sup>10)</sup>	■	180 <sup>5)</sup>		
					–	–	■	400 <sup>6)</sup>		
Dimensional drawing → F-126										
	1 m	0.5 mm	20 mm	-10 °C ... +60 °C	■	95 <sup>8)</sup>	■	40 <sup>3)</sup>	LL3-LM361000	2073494
					■	195 <sup>9)</sup>	■	130 <sup>4)</sup>		
					■	329 <sup>10)</sup>	■	160 <sup>5)</sup>		
					–	–	■	180 <sup>6)</sup>		
Dimensional drawing → F-129										
	1.25 m	0.5 mm	20 mm	-10 °C ... +60 °C	■	125 <sup>8)</sup>	■	40 <sup>3)</sup>	LL3-LM361250	2073495
					■	252 <sup>9)</sup>	■	130 <sup>4)</sup>		
					■	482 <sup>10)</sup>	■	160 <sup>5)</sup>		
					–	–	■	180 <sup>6)</sup>		
Dimensional drawing → F-129										

<sup>1)</sup> FC fiber optic fiber cutter included in scope of delivery.

<sup>2)</sup> Minimum detectable object was determined at optimal measuring distance and optimal setting.

<sup>3)</sup> Operating mode: 16 µs. <sup>4)</sup> Operating mode: 70 µs. <sup>5)</sup> Operating mode: 250 µs. <sup>6)</sup> Operating mode: 2 ms. <sup>7)</sup> Operating mode: 8 ms.

<sup>8)</sup> Operating mode: 250 µs (potentiometer). <sup>9)</sup> Operating mode: 50 µs (teach-in). <sup>10)</sup> Operating mode: 250 µs (teach-in).

Fiber optic cables with lengths different to the products shown here are available on request.

B

Figure	Length	Min. object diameter <sup>2)</sup>	Bend radius, fiber-optic cable	Ambient temperature, operation	Sensing range with GLL170 in mm		Sensing range with WLL180T in mm		Type	Part no.
	150 mm	0.5 mm	20 mm	-10 °C ... +60 °C	97 <sup>8)</sup>	50 <sup>3)</sup>	LL3-LM36150	2073491		
					132 <sup>9)</sup>	160 <sup>4)</sup>				
					229 <sup>10)</sup>	210 <sup>5)</sup>				
					-	240 <sup>6)</sup>				
					-	260 <sup>7)</sup>				
Dimensional drawing → F-129										
	450 mm	0.5 mm	20 mm	-10 °C ... +60 °C	70 <sup>8)</sup>	50 <sup>3)</sup>	LL3-LM36450	2073492		
					171 <sup>9)</sup>	160 <sup>4)</sup>				
					325 <sup>10)</sup>	210 <sup>5)</sup>				
					-	230 <sup>6)</sup>				
					-	260 <sup>7)</sup>				
Dimensional drawing → F-130										
	750 mm	0.5 mm	20 mm	-10 °C ... +60 °C	100 <sup>8)</sup>	40 <sup>3)</sup>	LL3-LM36750	2073493		
					140 <sup>9)</sup>	150 <sup>4)</sup>				
					260 <sup>10)</sup>	160 <sup>5)</sup>				
					-	180 <sup>6)</sup>				
					-	190 <sup>7)</sup>				
Dimensional drawing → F-130										
	150 mm	0.5 mm	20 mm	-10 °C ... +60 °C	108 <sup>8)</sup>	50 <sup>3)</sup>	LL3-LM37150	2073496		
					212 <sup>9)</sup>	160 <sup>4)</sup>				
					290 <sup>10)</sup>	240 <sup>5)</sup>				
					-	320 <sup>6)</sup>				
					-	340 <sup>7)</sup>				
Dimensional drawing → F-130										
	450 mm	0.5 mm	20 mm	-10 °C ... +60 °C	84 <sup>8)</sup>	50 <sup>3)</sup>	LL3-LM37450	2073497		
					177 <sup>9)</sup>	160 <sup>4)</sup>				
					250 <sup>10)</sup>	230 <sup>5)</sup>				
					-	290 <sup>6)</sup>				
					-	310 <sup>7)</sup>				
Dimensional drawing → F-130										
	750 mm	0.5 mm	20 mm	-10 °C ... +60 °C	115 <sup>8)</sup>	50 <sup>3)</sup>	LL3-LM37750	2073498		
					123 <sup>9)</sup>	160 <sup>4)</sup>				
					229 <sup>10)</sup>	220 <sup>5)</sup>				
					-	240 <sup>6)</sup>				
					-	270 <sup>7)</sup>				
Dimensional drawing → F-130										
	750 mm	0.5 mm	20 mm	-10 °C ... +60 °C	325 <sup>8)</sup>	100 <sup>3)</sup>	LL3-LM38750	2073503		
					592 <sup>9)</sup>	330 <sup>4)</sup>				
					992 <sup>10)</sup>	650 <sup>5)</sup>				
					-	1,300 <sup>6)</sup>				
					-	1,350 <sup>7)</sup>				
Dimensional drawing → F-130										
	750 mm	0.5 mm	20 mm	-10 °C ... +60 °C	465 <sup>8)</sup>	230 <sup>3)</sup>	LL3-LM38751	2073504		
					780 <sup>9)</sup>	690 <sup>4)</sup>				
					1,321 <sup>10)</sup>	1,320 <sup>5)</sup>				
					-	1,350 <sup>6)</sup>				
					-	1,350 <sup>7)</sup>				
Dimensional drawing → F-131										
	750 mm	0.5 mm	20 mm	-10 °C ... +60 °C	270 <sup>8)</sup>	130 <sup>3)</sup>	LL3-LM39750	2073506		
					441 <sup>9)</sup>	390 <sup>4)</sup>				
					742 <sup>10)</sup>	740 <sup>5)</sup>				
					-	1,350 <sup>6)</sup>				
					-	1,350 <sup>7)</sup>				
Dimensional drawing → F-131										

<sup>1)</sup> FC fiber optic fiber cutter included in scope of delivery.

<sup>2)</sup> Minimum detectable object was determined at optimal measuring distance and optimal setting.

<sup>3)</sup> Operating mode: 16 µs. <sup>4)</sup> Operating mode: 70 µs. <sup>5)</sup> Operating mode: 250 µs. <sup>6)</sup> Operating mode: 2 ms. <sup>7)</sup> Operating mode: 8 ms.

<sup>8)</sup> Operating mode: 250 µs (potentiometer). <sup>9)</sup> Operating mode: 50 µs (teach-in). <sup>10)</sup> Operating mode: 250 µs (teach-in).

Fiber optic cables with lengths different to the products shown here are available on request.



90° deflection, through-beam system

Figure	Length	Min. object diameter <sup>2)</sup>	Bend radius, fiber-optic cable	Ambient temperature, operation	Sensing range with GLL170 in mm		Sensing range with WLL180T in mm		Type	Part no.
	150 mm	0.5 mm	20 mm	-10 °C ... +60 °C		190 <sup>8)</sup>		140 <sup>3)</sup>	LL3-LM38150	2073501
						190 <sup>9)</sup>		200 <sup>4)</sup>		
						190 <sup>10)</sup>		200 <sup>5)</sup>		
						200 <sup>6)</sup>		200 <sup>6)</sup>		
						200 <sup>7)</sup>		200 <sup>7)</sup>		
Dimensional drawing → F-133										
	450 mm	0.5 mm	20 mm	-10 °C ... +60 °C		270 <sup>8)</sup>		140 <sup>3)</sup>	LL3-LM38450	2073502
						462 <sup>9)</sup>		490 <sup>4)</sup>		
						764 <sup>10)</sup>		750 <sup>5)</sup>		
						750 <sup>6)</sup>		750 <sup>6)</sup>		
						750 <sup>7)</sup>		750 <sup>7)</sup>		
Dimensional drawing → F-134										
	750 mm	0.5 mm	20 mm	-10 °C ... +60 °C		325 <sup>8)</sup>		100 <sup>3)</sup>	LL3-LM38750	2073503
						592 <sup>9)</sup>		330 <sup>4)</sup>		
						992 <sup>10)</sup>		650 <sup>5)</sup>		
						1,300 <sup>6)</sup>		1,300 <sup>6)</sup>		
						1,350 <sup>7)</sup>		1,350 <sup>7)</sup>		
Dimensional drawing → F-134										
	750 mm	0.5 mm	20 mm	-10 °C ... +60 °C		465 <sup>8)</sup>		230 <sup>3)</sup>	LL3-LM38751	2073504
						780 <sup>9)</sup>		690 <sup>4)</sup>		
						1,321 <sup>10)</sup>		1,320 <sup>5)</sup>		
						1,350 <sup>6)</sup>		1,350 <sup>6)</sup>		
						1,350 <sup>7)</sup>		1,350 <sup>7)</sup>		
Dimensional drawing → F-134										
	450 mm	0.5 mm	20 mm	-10 °C ... +60 °C		318 <sup>8)</sup>		130 <sup>3)</sup>	LL3-LM39450	2073505
						531 <sup>9)</sup>		390 <sup>4)</sup>		
						774 <sup>10)</sup>		740 <sup>5)</sup>		
						750 <sup>6)</sup>		750 <sup>6)</sup>		
						750 <sup>7)</sup>		750 <sup>7)</sup>		
Dimensional drawing → F-134										
	750 mm	0.5 mm	20 mm	-10 °C ... +60 °C		270 <sup>8)</sup>		130 <sup>3)</sup>	LL3-LM39750	2073506
						441 <sup>9)</sup>		390 <sup>4)</sup>		
						742 <sup>10)</sup>		740 <sup>5)</sup>		
						1,350 <sup>6)</sup>		1,350 <sup>6)</sup>		
						1,350 <sup>7)</sup>		1,350 <sup>7)</sup>		
Dimensional drawing → F-135										

<sup>1)</sup> FC fiber optic fiber cutter included in scope of delivery.

<sup>2)</sup> Minimum detectable object was determined at optimal measuring distance and optimal setting.

<sup>3)</sup> Operating mode: 16 μs. <sup>4)</sup> Operating mode: 70 μs. <sup>5)</sup> Operating mode: 250 μs. <sup>6)</sup> Operating mode: 2 ms. <sup>7)</sup> Operating mode: 8 ms.

<sup>8)</sup> Operating mode: 250 μs (potentiometer). <sup>9)</sup> Operating mode: 50 μs (teach-in). <sup>10)</sup> Operating mode: 250 μs (teach-in).

Fiber optic cables with lengths different to the products shown here are available on request.

**B**

B

Figure	Length	Min. object diameter <sup>2)</sup>	Bend radius, fiber-optic cable	Ambient temperature, operation	Sensing range with GLL170 in mm		Sensing range with WLL180T in mm		Type	Part no.
	2 m <sup>1)</sup>	0.05 mm	25 mm	-40 °C ... +70 °C	590 <sup>8)</sup>	150 <sup>3)</sup>	460 <sup>9)</sup>	480 <sup>4)</sup>	LL3-TB06	5325916
					660 <sup>10)</sup>	770 <sup>5)</sup>				
					-	1,500 <sup>6)</sup>				
					-	1,600 <sup>7)</sup>				
					Dimensional drawing → F-136					
	2 m <sup>1)</sup>	0.06 mm	1 mm	-40 °C ... +55 °C	1,730 <sup>8)</sup>	580 <sup>3)</sup>	1,650 <sup>9)</sup>	1,670 <sup>4)</sup>	LL3-TG02	5325943
					2,060 <sup>10)</sup>	2,400 <sup>5)</sup>				
					-	4,000 <sup>6)</sup>				
					-	4,000 <sup>7)</sup>				
					Dimensional drawing → F-137					
	2 m <sup>1)</sup>	0.02 mm	1 mm	-40 °C ... +60 °C	40 <sup>8)</sup>	13 <sup>3)</sup>	30 <sup>9)</sup>	50 <sup>4)</sup>	LL3-TG05	5325921
					60 <sup>10)</sup>	85 <sup>5)</sup>				
					-	170 <sup>6)</sup>				
					-	180 <sup>7)</sup>				
					Dimensional drawing → F-137					
	1 m <sup>1)</sup>	1 mm	10 mm	-40 °C ... +105 °C	20 <sup>8)</sup>	6 <sup>3)</sup>	10 <sup>9)</sup>	19 <sup>4)</sup>	LL3-TH06	5325926
					20 <sup>10)</sup>	38 <sup>5)</sup>				
					-	74 <sup>6)</sup>				
					-	130 <sup>7)</sup>				
					Dimensional drawing → F-138					
	2 m	0.1 mm	50 mm	-60 °C ... +200 °C	60 <sup>8)</sup>	18 <sup>3)</sup>	50 <sup>9)</sup>	30 <sup>4)</sup>	LL3-TH07	5325977
					90 <sup>10)</sup>	120 <sup>5)</sup>				
					-	220 <sup>6)</sup>				
					-	420 <sup>7)</sup>				
					Dimensional drawing → F-138					
	2 m <sup>1)</sup>	0.16 mm	25 mm	-60 °C ... +200 °C	270 <sup>8)</sup>	90 <sup>3)</sup>	290 <sup>9)</sup>	290 <sup>4)</sup>	LL3-TH15	5325975
					410 <sup>10)</sup>	480 <sup>5)</sup>				
					-	970 <sup>6)</sup>				
					-	1,000 <sup>7)</sup>				
					Dimensional drawing → F-139					
	2 m <sup>1)</sup>	0.16 mm	25 mm	-60 °C ... +200 °C	270 <sup>8)</sup>	90 <sup>3)</sup>	290 <sup>9)</sup>	290 <sup>4)</sup>	LL3-TH16	5325976
					410 <sup>10)</sup>	480 <sup>5)</sup>				
					-	970 <sup>6)</sup>				
					-	1,000 <sup>7)</sup>				
					Dimensional drawing → F-140					
	2 m <sup>1)</sup>	0.2 mm	25 mm	-40 °C ... +100 °C	590 <sup>8)</sup>	180 <sup>3)</sup>	530 <sup>9)</sup>	600 <sup>4)</sup>	LL3-TK16	5313038
					790 <sup>10)</sup>	1,100 <sup>5)</sup>				
					-	2,500 <sup>6)</sup>				
					-	3,300 <sup>7)</sup>				
					Dimensional drawing → F-140					

<sup>1)</sup> FC fiber optic fiber cutter included in scope of delivery.

<sup>2)</sup> Minimum detectable object was determined at optimal measuring distance and optimal setting.

<sup>3)</sup> Operating mode: 16 µs. <sup>4)</sup> Operating mode: 70 µs. <sup>5)</sup> Operating mode: 250 µs. <sup>6)</sup> Operating mode: 2 ms. <sup>7)</sup> Operating mode: 8 ms.

<sup>8)</sup> Operating mode: 250 µs (potentiometer). <sup>9)</sup> Operating mode: 50 µs (teach-in). <sup>10)</sup> Operating mode: 250 µs (teach-in).

Fiber optic cables with lengths different to the products shown here are available on request.



**B**

Figure	Length	Min. object diameter <sup>2)</sup>	Bend radius, fiber-optic cable	Ambient temperature, operation	Sensing range with GLL170 in mm		Sensing range with WLL180T in mm		Type	Part no.
		0.06 mm	1 mm	-40 °C ... +60 °C	560 <sup>8)</sup>	160 <sup>3)</sup>	LL3-TR08	5325984		
					470 <sup>9)</sup>	480 <sup>4)</sup>				
					690 <sup>10)</sup>	800 <sup>5)</sup>				
					-	1,600 <sup>6)</sup>				
					-	1,700 <sup>7)</sup>				
Dimensional drawing → F-142										
		0.04 mm	1 mm	-40 °C ... +60 °C	1,490 <sup>8)</sup>	360 <sup>3)</sup>	LL3-TR09	5325985		
					1,220 <sup>9)</sup>	1,200 <sup>4)</sup>				
					1,970 <sup>10)</sup>	2,200 <sup>5)</sup>				
					-	4,000 <sup>6)</sup>				
					-	4,000 <sup>7)</sup>				
Dimensional drawing → F-142										
		0.2 mm	25 mm	-40 °C ... +70 °C	410 <sup>8)</sup>	170 <sup>3)</sup>	LL3-TS08	5308061		
					410 <sup>9)</sup>	500 <sup>4)</sup>				
					710 <sup>10)</sup>	1,000 <sup>5)</sup>				
					-	2,300 <sup>6)</sup>				
					-	3,000 <sup>7)</sup>				
Dimensional drawing → F-143										
		0.5 mm	25 mm	-40 °C ... +70 °C	350 <sup>8)</sup>	170 <sup>3)</sup>	LL3-TS12	5308062		
					350 <sup>9)</sup>	550 <sup>4)</sup>				
					350 <sup>10)</sup>	1,000 <sup>5)</sup>				
					-	2,300 <sup>6)</sup>				
					-	3,000 <sup>7)</sup>				
Dimensional drawing → F-143										
	2 m <sup>1)</sup>		25 mm	-40 °C ... +70 °C	1,470 <sup>8)</sup>	390 <sup>3)</sup>	LL3-TS22	5325944		
					1,130 <sup>9)</sup>	1,300 <sup>4)</sup>				
					1,980 <sup>10)</sup>	2,600 <sup>5)</sup>				
					-	4,000 <sup>6)</sup>				
					-	4,000 <sup>7)</sup>				
Dimensional drawing → F-144										
			10 mm	-40 °C ... +105 °C	1,190 <sup>8)</sup>	220 <sup>3)</sup>	LL3-TS22M	5325968		
					1,040 <sup>9)</sup>	760 <sup>4)</sup>				
					1,740 <sup>10)</sup>	1,500 <sup>5)</sup>				
					-	2,900 <sup>6)</sup>				
					-	4,000 <sup>7)</sup>				
Dimensional drawing → F-144										
		0.2 mm	25 mm	-40 °C ... +70 °C	270 <sup>8)</sup>	120 <sup>3)</sup>	LL3-TV01	5308058		
					250 <sup>9)</sup>	400 <sup>4)</sup>				
					440 <sup>10)</sup>	800 <sup>5)</sup>				
					-	1,800 <sup>6)</sup>				
					-	2,750 <sup>7)</sup>				
Dimensional drawing → F-144										
		0.1 mm	15 mm	-40 °C ... +70 °C	110 <sup>8)</sup>	30 <sup>3)</sup>	LL3-TV02	5308059		
					90 <sup>9)</sup>	130 <sup>4)</sup>				
					170 <sup>10)</sup>	250 <sup>5)</sup>				
					-	550 <sup>6)</sup>				
					-	800 <sup>7)</sup>				
Dimensional drawing → F-144										
		0.1 mm	15 mm	-40 °C ... +70 °C	80 <sup>8)</sup>	30 <sup>3)</sup>	LL3-TV04	5308060		
					110 <sup>9)</sup>	130 <sup>4)</sup>				
					170 <sup>10)</sup>	250 <sup>5)</sup>				
					-	550 <sup>6)</sup>				
					-	800 <sup>7)</sup>				
Dimensional drawing → F-144										

<sup>1)</sup> FC fiber optic fiber cutter included in scope of delivery.

<sup>2)</sup> Minimum detectable object was determined at optimal measuring distance and optimal setting.

<sup>3)</sup> Operating mode: 16 µs. <sup>4)</sup> Operating mode: 70 µs. <sup>5)</sup> Operating mode: 250 µs. <sup>6)</sup> Operating mode: 2 ms. <sup>7)</sup> Operating mode: 8 ms.

<sup>8)</sup> Operating mode: 250 µs (potentiometer). <sup>9)</sup> Operating mode: 50 µs (teach-in). <sup>10)</sup> Operating mode: 250 µs (teach-in).

Fiber optic cables with lengths different to the products shown here are available on request.

B

Figure	Length	Min. object diameter <sup>2)</sup>	Bend radius, fiber-optic cable	Ambient temperature, operation	Sensing range with GLL170 in mm		Sensing range with WLL180T in mm		Type	Part no.
	2 m <sup>1)</sup>	0.4 mm	25 mm	-40 °C ... +70 °C	 640 <sup>8)</sup>	 350 <sup>3)</sup>	LL3-TV05	5322546		
					 620 <sup>9)</sup>	 750 <sup>4)</sup>				
	2 m <sup>1)</sup>	0.4 mm	25 mm	-40 °C ... +105 °C	 1,410 <sup>10)</sup>	 1,800 <sup>5)</sup>	LL3-TV06	5322547	Dimensional drawing → F-144	
					-	 4,000 <sup>6)</sup>				
	2 m <sup>1)</sup>	0.4 mm	2 mm	-40 °C ... +70 °C	 560 <sup>8)</sup>	 180 <sup>3)</sup>	LL3-TV07	5322548	Dimensional drawing → F-144	
					 460 <sup>9)</sup>	 550 <sup>4)</sup>				
	2 m <sup>1)</sup>	0.05 mm	25 mm	-40 °C ... +60 °C	 680 <sup>10)</sup>	 900 <sup>5)</sup>	LL3-TV08	5325922	Dimensional drawing → F-145	
					-	 2,100 <sup>6)</sup>				
	2 m <sup>1)</sup>	0.4 mm	2 mm	-40 °C ... +70 °C	 460 <sup>8)</sup>	 340 <sup>3)</sup>	LL3-TV77	5326557	Dimensional drawing → F-145	
					 840 <sup>9)</sup>	 1,000 <sup>4)</sup>				
	2 m <sup>1)</sup>	0.3 mm	60 mm	-40 °C ... +70 °C	 1,290 <sup>10)</sup>	 1,800 <sup>5)</sup>	LL3-TY02	5308067	Dimensional drawing → F-146	
					-	 4,000 <sup>6)</sup>				
	3 m <sup>1)</sup>	0.3 mm	20 mm	-55 °C ... +70 °C	 4,000 <sup>7)</sup>	 4,000 <sup>7)</sup>	LL3-TY03	5325982	Dimensional drawing → F-146	
					 200 <sup>8)</sup>	 340 <sup>3)</sup>				
	3 m <sup>1)</sup>	0.3 mm	20 mm	-55 °C ... +70 °C	 640 <sup>9)</sup>	 1,000 <sup>4)</sup>	LL3-TY03	5325982	Dimensional drawing → F-146	
					 1,068 <sup>10)</sup>	 1,800 <sup>5)</sup>				
	3 m <sup>1)</sup>	0.3 mm	20 mm	-55 °C ... +70 °C	-	 4,000 <sup>6)</sup>	LL3-TY03	5325982	Dimensional drawing → F-146	
					-	 4,000 <sup>7)</sup>				

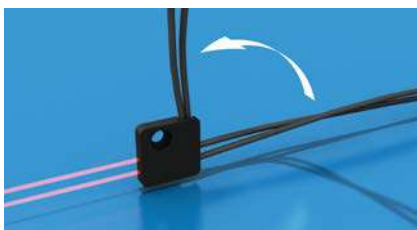
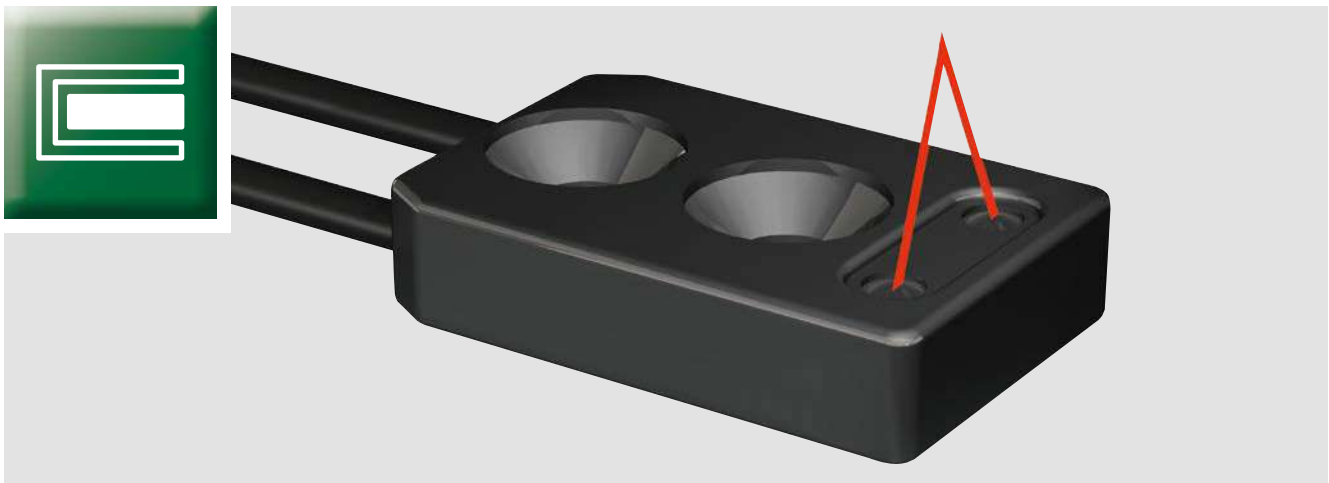
<sup>1)</sup> FC fiber optic fiber cutter included in scope of delivery.

<sup>2)</sup> Minimum detectable object was determined at optimal measuring distance and optimal setting.

<sup>3)</sup> Operating mode: 16 µs. <sup>4)</sup> Operating mode: 70 µs. <sup>5)</sup> Operating mode: 250 µs. <sup>6)</sup> Operating mode: 2 ms. <sup>7)</sup> Operating mode: 8 ms.

<sup>8)</sup> Operating mode: 250 µs (potentiometer). <sup>9)</sup> Operating mode: 50 µs (teach-in). <sup>10)</sup> Operating mode: 250 µs (teach-in).

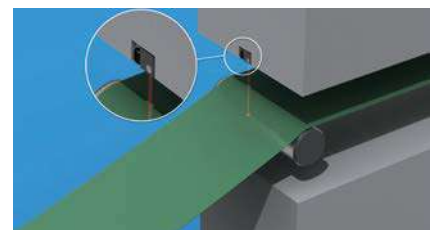
Fiber optic cables with lengths different to the products shown here are available on request.



The adjustable fiber-optic cable allows the same model to be used with the light emission pointing upward or to the side



Flush installation in the side frames



Detection of sheets

### Flat design

The rectangular, flat fibers are easy to mount. The fiber-optic cable of the LL3-xE02 and LL3-xE04 models can be adjusted so that the light emission points upward or to the side. This reduces the number of models that need to be stored in the warehouse.



### Flat design, proximity system

Figure	Length	Min. object diameter <sup>2)</sup>	Bend radius, fiber-optic cable	Ambient temperature, operation	Sensing range with GLL170 in mm		Sensing range with WLL180T in mm		Type	Part no.
	4 m <sup>1)</sup>	0.3 mm	25 mm	-40 °C ... +60 °C		48 <sup>8)</sup>		60 <sup>3)</sup>	LL3-DC03	5326020
						48 <sup>9)</sup>		75 <sup>4)</sup>		
						64 <sup>10)</sup>		85 <sup>5)</sup>		
						-		150 <sup>6)</sup>		
						-		280 <sup>7)</sup>		
	3 m <sup>1)</sup>	-	4 mm	0 °C ... +70 °C		14 <sup>8)</sup>		18 <sup>3)</sup>	LL3-DC04	5326018
						16 <sup>9)</sup>		31 <sup>4)</sup>		
						19 <sup>10)</sup>		34 <sup>5)</sup>		
						-		38 <sup>6)</sup>		
						-		38 <sup>7)</sup>		

<sup>1)</sup> FC fiber optic fiber cutter included in scope of delivery.

<sup>2)</sup> Minimum detectable object was determined at optimal measuring distance and optimal setting.










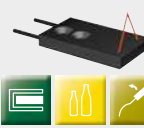








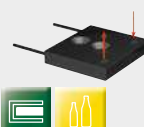



































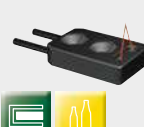
















<sup>3)</sup> Operating mode: 16 µs. <sup>4)</sup> Operating mode: 70 µs. <sup>5)</sup> Operating mode: 250 µs. <sup>6)</sup> Operating mode: 2 ms. <sup>7)</sup> Operating mode: 8 ms.

<sup>8)</sup> Operating mode: 250 µs (potentiometer). <sup>9)</sup> Operating mode: 50 µs (teach-in). <sup>10)</sup> Operating mode: 250 µs (teach-in).

<sup>11)</sup> Retro-reflective fiber with polarizing filter and reflector.

Fiber optic cables with lengths different to the products shown here are available on request.

B

Figure	Length	Min. object diameter <sup>2)</sup>	Bend radius, fiber-optic cable	Ambient temperature, operation	Sensing range with GLL170 in mm		Sensing range with WLL180T in mm		Type	Part no.
	3 m	25 mm	25 mm	0 °C ... +70 °C	 25 <sup>8)</sup>	 18 <sup>3)</sup>	LL3-DC05	5326016		
					 30 <sup>9)</sup>	 29 <sup>4)</sup>				
					 33 <sup>10)</sup>	 35 <sup>5)</sup>				
					-	 40 <sup>6)</sup>				
					-	 43 <sup>7)</sup>				
Dimensional drawing → F-116										
	2 m <sup>1)</sup>	-	4 mm	0 °C ... +70 °C	 9 <sup>8)</sup>	 15 <sup>3)</sup>	LL3-DC06	5326017		
					 11 <sup>9)</sup>	 22 <sup>4)</sup>				
					 12 <sup>10)</sup>	 23 <sup>5)</sup>				
					-	 25 <sup>6)</sup>				
					-	 25 <sup>7)</sup>				
Dimensional drawing → F-116										
	0.06 mm	10 mm	-40 °C ... +60 °C	-40 °C ... +60 °C	 9 <sup>8)</sup>	 8 <sup>3)</sup>	LL3-DC07	5326019		
					 6.5 <sup>9)</sup>	 12 <sup>4)</sup>				
					 8 <sup>10)</sup>	 14 <sup>5)</sup>				
					-	 16 <sup>6)</sup>				
					-	 18 <sup>7)</sup>				
Dimensional drawing → F-116										
	1 m <sup>1)</sup>	0.3 mm	1 mm	-20 °C ... +60 °C	 6 <sup>8)</sup>	 2 <sup>3)</sup>	LL3-DC08	5326029		
					 7 <sup>9)</sup>	 4 <sup>4)</sup>				
					 8 <sup>10)</sup>	 6 <sup>5)</sup>				
					-	 9 <sup>6)</sup>				
					-	 10 <sup>7)</sup>				
Dimensional drawing → F-117										
	-	-	-	-40 °C ... +70 °C	 9 <sup>8)</sup>	 8 <sup>3)</sup>	LL3-DC09	5326028		
					 114 <sup>9)</sup>	 10 <sup>4)</sup>				
					 19 <sup>10)</sup>	 11 <sup>5)</sup>				
					-	 13 <sup>6)</sup>				
					-	 17 <sup>7)</sup>				
Dimensional drawing → F-117										
	2 m <sup>1)</sup>	0.02 mm	10 mm	-40 °C ... +50 °C	 8 <sup>7)</sup>	 6 <sup>2)</sup>	LL3-DC38	5322472		
					 9 <sup>8)</sup>	 6 <sup>3)</sup>				
					 13 <sup>9)</sup>	 6 <sup>4)</sup>				
					-	 10 <sup>5)</sup>				
					-	 15 <sup>6)</sup>				
Dimensional drawing → F-117										
	-	-	-	-40 °C ... +50 °C	 4 <sup>8)</sup>	-	LL3-DC39	5322513		
					 6 <sup>9)</sup>	 4 <sup>4)</sup>				
					 7 <sup>10)</sup>	 4 <sup>5)</sup>				
					-	 4 <sup>6)</sup>				
					-	 4 <sup>7)</sup>				
Dimensional drawing → F-117										
	-	0.01 mm	1 mm	-40 °C ... +60 °C	 32 <sup>8)</sup>	 12 <sup>3)</sup>	LL3-DC47	5324268		
					 30 <sup>9)</sup>	 25 <sup>4)</sup>				
					 52 <sup>10)</sup>	 37 <sup>5)</sup>				
					-	 75 <sup>6)</sup>				
					-	 90 <sup>7)</sup>				
Dimensional drawing → F-117										

<sup>1)</sup> FC fiber optic fiber cutter included in scope of delivery.







































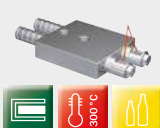








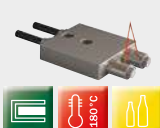








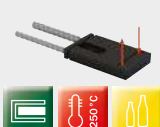








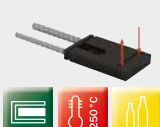


















<sup>2)</sup> Minimum detectable object was determined at optimal measuring distance and optimal setting.

<sup>3)</sup> Operating mode: 16 µs. <sup>4)</sup> Operating mode: 70 µs. <sup>5)</sup> Operating mode: 250 µs. <sup>6)</sup> Operating mode: 2 ms. <sup>7)</sup> Operating mode: 8 ms.

<sup>8)</sup> Operating mode: 250 µs (potentiometer). <sup>9)</sup> Operating mode: 50 µs (teach-in). <sup>10)</sup> Operating mode: 250 µs (teach-in).

<sup>11)</sup> Retro-reflective fiber with polarizing filter and reflector.

Fiber optic cables with lengths different to the products shown here are available on request.

Figure	Length	Min. object diameter <sup>2)</sup>	Bend radius, fiber-optic cable	Ambient temperature, operation	Sensing range with GLL170 in mm		Sensing range with WLL180T in mm		Type	Part no.
	1 m <sup>1)</sup>	0.16 mm	1 mm	-40 °C ... +60 °C	 40 <sup>8)</sup>	 11 <sup>3)</sup>	LL3-DE01	5325285		
					 20 <sup>9)</sup>	 38 <sup>4)</sup>				
					 50 <sup>10)</sup>	 78 <sup>5)</sup>				
					-	 150 <sup>6)</sup>				
					-	 160 <sup>7)</sup>				
Dimensional drawing → F-117										
		0.01 mm	1 mm	-40 °C ... +60 °C	 40 <sup>8)</sup>	 13 <sup>3)</sup>	LL3-DE02	5324497		
					 30 <sup>9)</sup>	 48 <sup>4)</sup>				
					 60 <sup>10)</sup>	 86 <sup>5)</sup>				
					-	 170 <sup>6)</sup>				
					-	 180 <sup>7)</sup>				
Dimensional drawing → F-118										
	2 m <sup>1)</sup>	0.03 mm	1 mm	-40 °C ... +60 °C	 150 <sup>8)</sup>	 45 <sup>3)</sup>	LL3-DE03	5325986		
					 90 <sup>9)</sup>	 130 <sup>4)</sup>				
					 180 <sup>10)</sup>	 250 <sup>5)</sup>				
					-	 510 <sup>6)</sup>				
					-	 550 <sup>7)</sup>				
Dimensional drawing → F-118										
		0.03 mm	1 mm	-40 °C ... +60 °C	 150 <sup>8)</sup>	 50 <sup>3)</sup>	LL3-DE04	5325987		
					 90 <sup>9)</sup>	 130 <sup>4)</sup>				
					 180 <sup>10)</sup>	 250 <sup>5)</sup>				
					-	 500 <sup>6)</sup>				
					-	 540 <sup>7)</sup>				
Dimensional drawing → F-118										
	2 m	0.02 mm	25 mm	-30 °C ... +300 °C	 14 <sup>8)</sup>	 5 <sup>3)</sup>	LL3-DH06	5326026		
					 20 <sup>9)</sup>	 10 <sup>4)</sup>				
					 30 <sup>10)</sup>	 19 <sup>5)</sup>				
					-	 37 <sup>6)</sup>				
					-	 43 <sup>7)</sup>				
Dimensional drawing → F-120										
	2 m <sup>1)</sup>	0.02 mm	25 mm	-60 °C ... +180 °C	 7 <sup>8)</sup>	 5 <sup>3)</sup>	LL3-DH08	5326025		
					 6 <sup>9)</sup>	 11 <sup>4)</sup>				
					 12 <sup>10)</sup>	 22 <sup>5)</sup>				
					-	 30 <sup>6)</sup>				
					-	 38 <sup>7)</sup>				
Dimensional drawing → F-120										
	3 m	0.02 mm	25 mm	-20 °C ... +250 °C	 16.8 <sup>8)</sup>	 11 <sup>3)</sup>	LL3-DH10	5326023		
					 9 <sup>9)</sup>	 18 <sup>4)</sup>				
					 13 <sup>10)</sup>	 21 <sup>5)</sup>				
					-	 24 <sup>6)</sup>				
					-	 26 <sup>7)</sup>				
Dimensional drawing → F-120										
		0.02 mm	25 mm	-20 °C ... +250 °C	 26 <sup>8)</sup>	 19 <sup>3)</sup>	LL3-DH11	5326024		
					 14.5 <sup>9)</sup>	 29 <sup>4)</sup>				
					 19 <sup>10)</sup>	 34 <sup>5)</sup>				
					-	 39 <sup>6)</sup>				
					-	 42 <sup>7)</sup>				
Dimensional drawing → F-120										
	2 m <sup>1)</sup>	0.03 mm	1 mm	-20 °C ... +70 °C	 370 <sup>8)</sup>	 110 <sup>3)</sup>	LL3-DR09	5325528		
					 230 <sup>9)</sup>	 345 <sup>4)</sup>				
					 400 <sup>10)</sup>	 560 <sup>5)</sup>				
					-	 1,100 <sup>6)</sup>				
					-	 1,190 <sup>7)</sup>				
Dimensional drawing → F-124										

<sup>1)</sup> FC fiber optic fiber cutter included in scope of delivery.










<sup>2)</sup> Minimum detectable object was determined at optimal measuring distance and optimal setting.

<sup>3)</sup> Operating mode: 16 µs. <sup>4)</sup> Operating mode: 70 µs. <sup>5)</sup> Operating mode: 250 µs. <sup>6)</sup> Operating mode: 2 ms. <sup>7)</sup> Operating mode: 8 ms.

<sup>8)</sup> Operating mode: 250 µs (potentiometer). <sup>9)</sup> Operating mode: 50 µs (teach-in). <sup>10)</sup> Operating mode: 250 µs (teach-in).

<sup>11)</sup> Retro-reflective fiber with polarizing filter and reflector.

Fiber optic cables with lengths different to the products shown here are available on request.

Figure	Length	Min. object diameter <sup>2)</sup>	Bend radius, fiber-optic cable	Ambient temperature, operation	Sensing range with GLL170 in mm		Sensing range with WLL180T in mm		Type	Part no.
	2 m <sup>1)</sup>	0.3 mm	1 mm	-25 °C ... +55 °C	 410 <sup>8)</sup>	 290 <sup>3)</sup>	LL3-RR01 <sup>11)</sup>	5326008		
					 380 <sup>9)</sup>	 580 <sup>4)</sup>				
					 520 <sup>10)</sup>	 720 <sup>5)</sup>				
					-	 1,450 <sup>6)</sup>				
					-	 1,550 <sup>7)</sup>				
Dimensional drawing → <a href="#">F-132</a>										

<sup>1)</sup> FC fiber optic fiber cutter included in scope of delivery.

<sup>2)</sup> Minimum detectable object was determined at optimal measuring distance and optimal setting.

<sup>3)</sup> Operating mode: 16 µs. <sup>4)</sup> Operating mode: 70 µs. <sup>5)</sup> Operating mode: 250 µs. <sup>6)</sup> Operating mode: 2 ms. <sup>7)</sup> Operating mode: 8 ms.

<sup>8)</sup> Operating mode: 250 µs (potentiometer). <sup>9)</sup> Operating mode: 50 µs (teach-in). <sup>10)</sup> Operating mode: 250 µs (teach-in).

<sup>11)</sup> Retro-reflective fiber with polarizing filter and reflector.

Fiber optic cables with lengths different to the products shown here are available on request.

B



Flat design, through-beam system

**B**

Figure	Length	Min. object diameter <sup>2)</sup>	Bend radius, fiber-optic cable	Ambient temperature, operation	Sensing range with GLL170 in mm		Sensing range with WLL180T in mm		Type	Part no.
	2 m <sup>1)</sup>	0.01 mm	1 mm	-40 °C ... +60 °C		117 <sup>8)</sup>		35 <sup>2)</sup>	LL3-DC57	5324269
						178 <sup>9)</sup>		45 <sup>3)</sup>		
						300 <sup>10)</sup>		55 <sup>4)</sup>		
					-	-		250 <sup>5)</sup>		
					-	-		330 <sup>6)</sup>		
Dimensional drawing → F-133										
	1 m <sup>1)</sup>	0.08 mm	1 mm	-40 °C ... +60 °C		480 <sup>8)</sup>		120 <sup>3)</sup>	LL3-TE01	5325807
						370 <sup>9)</sup>		350 <sup>4)</sup>		
						630 <sup>10)</sup>		620 <sup>5)</sup>		
					-	-		1,250 <sup>6)</sup>		
					-	-		1,330 <sup>7)</sup>		
Dimensional drawing → F-136										
	1 m <sup>1)</sup>	0.08 mm	1 mm	-40 °C ... +60 °C		180 <sup>8)</sup>		40 <sup>3)</sup>	LL3-TE02	5325910
						140 <sup>9)</sup>		140 <sup>4)</sup>		
						190 <sup>10)</sup>		220 <sup>5)</sup>		
					-	-		450 <sup>6)</sup>		
					-	-		480 <sup>7)</sup>		
Dimensional drawing → F-136										
	2 m <sup>1)</sup>	0.08 mm	1 mm	-40 °C ... +60 °C		760 <sup>8)</sup>		190 <sup>3)</sup>	LL3-TE03	5325908
						600 <sup>9)</sup>		580 <sup>4)</sup>		
						1,010 <sup>10)</sup>		980 <sup>5)</sup>		
					-	-		1,970 <sup>6)</sup>		
					-	-		2,100 <sup>7)</sup>		
Dimensional drawing → F-136										
	2 m <sup>1)</sup>	0.03 mm	1 mm	-40 °C ... +60 °C		500 <sup>8)</sup>		150 <sup>3)</sup>	LL3-TE04	5325911
						430 <sup>9)</sup>		440 <sup>4)</sup>		
						600 <sup>10)</sup>		700 <sup>5)</sup>		
					-	-		1,400 <sup>6)</sup>		
					-	-		1,490 <sup>7)</sup>		
Dimensional drawing → F-137										
	2 m <sup>1)</sup>	0.03 mm	4 mm	-40 °C ... +60 °C		570 <sup>8)</sup>		150 <sup>3)</sup>	LL3-TE05	5325914
						450 <sup>9)</sup>		460 <sup>4)</sup>		
						720 <sup>10)</sup>		840 <sup>5)</sup>		
					-	-		1,680 <sup>6)</sup>		
					-	-		1,780 <sup>7)</sup>		
Dimensional drawing → F-137										

<sup>1)</sup> FC fiber optic fiber cutter included in scope of delivery.

<sup>2)</sup> Minimum detectable object was determined at optimal measuring distance and optimal setting.












































<sup>3)</sup> Operating mode: 16 μs. <sup>4)</sup> Operating mode: 70 μs. <sup>5)</sup> Operating mode: 250 μs. <sup>6)</sup> Operating mode: 2 ms. <sup>7)</sup> Operating mode: 8 ms.

<sup>8)</sup> Operating mode: 250 μs (potentiometer). <sup>9)</sup> Operating mode: 50 μs (teach-in). <sup>10)</sup> Operating mode: 250 μs (teach-in).

Fiber optic cables with lengths different to the products shown here are available on request.



B

Figure	Length	Min. object diameter <sup>2)</sup>	Bend radius, fiber-optic cable	Ambient temperature, operation	Sensing range with GLL170 in mm		Sensing range with WLL180T in mm		Type	Part no.
	2 m <sup>4)</sup>	0.03 mm	4 mm	-40 °C ... +60 °C	 1,830 <sup>8)</sup>	 360 <sup>3)</sup>	LL3-TR05	5325808	Dimensional drawing → F-141	
					 1,280 <sup>9)</sup>	 1,300 <sup>4)</sup>				
					 2,000 <sup>10)</sup>	 2,300 <sup>5)</sup>				
					-	 4,000 <sup>6)</sup>				
					-	 4,000 <sup>7)</sup>				
					 1,830 <sup>8)</sup>	 560 <sup>3)</sup>				
					 1,600 <sup>9)</sup>	 1,600 <sup>4)</sup>				
					 1,950 <sup>10)</sup>	 2,200 <sup>5)</sup>				
					-	 4,000 <sup>6)</sup>				
					-	 4,000 <sup>7)</sup>				
	2 m <sup>4)</sup>	0.08 mm	1 mm	-40 °C ... +60 °C	 1,570 <sup>8)</sup>	 590 <sup>3)</sup>	LL3-TR11	5325906	Dimensional drawing → F-142	
					 1,490 <sup>9)</sup>	 1,500 <sup>4)</sup>				
					 1,950 <sup>10)</sup>	 2,200 <sup>5)</sup>				
					-	 4,000 <sup>6)</sup>				
					-	 4,000 <sup>7)</sup>				
					 2,130 <sup>8)</sup>	 600 <sup>3)</sup>				
					 1,410 <sup>9)</sup>	 1,400 <sup>4)</sup>				
					 2,000 <sup>10)</sup>	 2,300 <sup>5)</sup>				
					-	 4,000 <sup>6)</sup>				
					-	 4,000 <sup>7)</sup>				
	2 m <sup>4)</sup>	0.05 mm	1 mm	-40 °C ... +60 °C	 920 <sup>8)</sup>	 250 <sup>3)</sup>	LL3-TR13	5325909	Dimensional drawing → F-143	
					 720 <sup>9)</sup>	 730 <sup>4)</sup>				
					 1,210 <sup>10)</sup>	 1,280 <sup>5)</sup>				
					-	 2,560 <sup>6)</sup>				
					-	 2,730 <sup>7)</sup>				

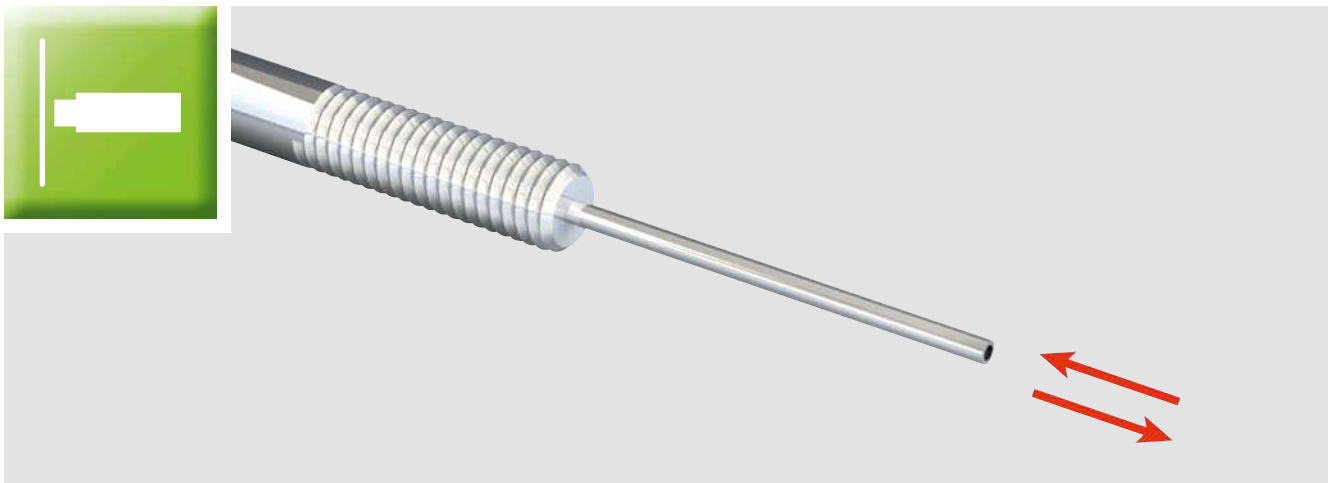
<sup>1)</sup> FC fiber optic fiber cutter included in scope of delivery.

<sup>2)</sup> Minimum detectable object was determined at optimal measuring distance and optimal setting.

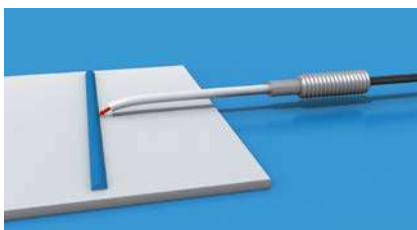
<sup>3)</sup> Operating mode: 16 µs. <sup>4)</sup> Operating mode: 70 µs. <sup>5)</sup> Operating mode: 250 µs. <sup>6)</sup> Operating mode: 2 ms. <sup>7)</sup> Operating mode: 8 ms.

<sup>8)</sup> Operating mode: 250 µs (potentiometer). <sup>9)</sup> Operating mode: 50 µs (teach-in). <sup>10)</sup> Operating mode: 250 µs (teach-in).

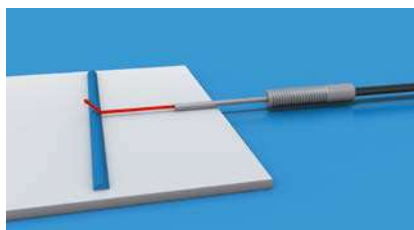
Fiber optic cables with lengths different to the products shown here are available on request.



**B**



Bendable end sleeves



Standard model with long end sleeves

### Long end sleeve

Fibers with long end sleeves are easy to position even in the tightest of spaces. This provides reliable detection of even the smallest objects. Bendable end sleeves offer maximum flexibility for alignment.



### Long end sleeve, proximity system

Figure	Length	Min. object diameter <sup>2)</sup>	Bend radius, fiber-optic cable	Ambient temperature, operation	Sensing range with GLL170 in mm		Sensing range with WLL180T in mm		Type	Part no.
	2 m <sup>1)</sup>	0.015 mm	25 mm	-40 °C ... +70 °C		160 <sup>8)</sup>		100 <sup>3)</sup>	LL3-DB02	5308083
						180 <sup>9)</sup>		350 <sup>4)</sup>		
						340 <sup>10)</sup>		580 <sup>5)</sup>		
						850 <sup>6)</sup>		1,300 <sup>7)</sup>		
					Dimensional drawing → F-114					
	1 m	0.02 mm	25 mm	-40 °C ... +60 °C		20 <sup>8)</sup>		8 <sup>3)</sup>	LL3-DB05	5326002
						10 <sup>9)</sup>		25 <sup>4)</sup>		
						30 <sup>10)</sup>		52 <sup>5)</sup>		
						100 <sup>6)</sup>		110 <sup>7)</sup>		
					Dimensional drawing → F-115					

<sup>1)</sup> FC fiber optic fiber cutter included in scope of delivery.














































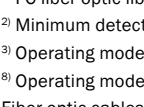









<sup>2)</sup> Minimum detectable object was determined at optimal measuring distance and optimal setting.

<sup>3)</sup> Operating mode: 16 μs. <sup>4)</sup> Operating mode: 70 μs. <sup>5)</sup> Operating mode: 250 μs. <sup>6)</sup> Operating mode: 2 ms. <sup>7)</sup> Operating mode: 8 ms.

<sup>8)</sup> Operating mode: 250 μs (potentiometer). <sup>9)</sup> Operating mode: 50 μs (teach-in). <sup>10)</sup> Operating mode: 250 μs (teach-in).

Fiber optic cables with lengths different to the products shown here are available on request.

B

Figure	Length	Min. object diameter <sup>2)</sup>	Bend radius, fiber-optic cable	Ambient temperature, operation	Sensing range with GLL170 in mm		Sensing range with WLL180T in mm		Type	Part no.
	2 m <sup>4)</sup>	0.02 mm	25 mm	-40 °C ... +70 °C	 210 <sup>8)</sup>	 60 <sup>3)</sup>	LL3-DB06	5326006		
					 140 <sup>9)</sup>	 210 <sup>4)</sup>				
	2 m <sup>4)</sup>	0.02 mm	25 mm	-40 °C ... +70 °C	 250 <sup>10)</sup>	 360 <sup>5)</sup>	LL3-DB08	5326004	Dimensional drawing → F-115	
					 -	 700 <sup>6)</sup>				
	2 m	0.02 mm	25 mm	-30 °C ... +350 °C	 60 <sup>8)</sup>	 17 <sup>3)</sup>	LL3-DH04	5326022	Dimensional drawing → F-115	
					 30 <sup>9)</sup>	 55 <sup>4)</sup>				
	1 m	0.02 mm	25 mm	-30 °C ... +350 °C	 70 <sup>10)</sup>	 107 <sup>5)</sup>	LL3-DH05	5326021	Dimensional drawing → F-119	
					 -	 200 <sup>6)</sup>				
	2 m <sup>4)</sup>	0.025 mm	25 mm	-40 °C ... +70 °C	 -	 220 <sup>7)</sup>	LL3-DK33	5313031	Dimensional drawing → F-115	
					 -	 220 <sup>7)</sup>				
	2 m <sup>4)</sup>	0.015 mm	15 mm	-40 °C ... +70 °C	 150 <sup>8)</sup>	 65 <sup>3)</sup>	LL3-DK43	5313030	Dimensional drawing → F-121	
					 150 <sup>9)</sup>	 225 <sup>4)</sup>				
	2 m <sup>4)</sup>	0.015 mm	2 mm	-40 °C ... +70 °C	 360 <sup>10)</sup>	 500 <sup>5)</sup>	LL3-DK63Z	5313027	Dimensional drawing → F-122	
					 -	 1,000 <sup>6)</sup>				
	2 m <sup>4)</sup>	0.015 mm	15 mm	-40 °C ... +70 °C	 -	 1,060 <sup>7)</sup>	LL3-DM03	5308084	Dimensional drawing → F-122	
					 -	 1,060 <sup>7)</sup>				
	500 mm	0.015 mm	4 mm	-40 °C ... +70 °C	 100 <sup>8)</sup>	 35 <sup>3)</sup>	LL3-DR05	5308087	Dimensional drawing → F-123	
					 80 <sup>9)</sup>	 135 <sup>4)</sup>				
	500 mm	0.015 mm	4 mm	-40 °C ... +70 °C	 170 <sup>10)</sup>	 170 <sup>5)</sup>	LL3-DR05	5308087	Dimensional drawing → F-123	
					 -	 290 <sup>6)</sup>				
	500 mm	0.015 mm	4 mm	-40 °C ... +70 °C	 -	 320 <sup>7)</sup>	LL3-DR05	5308087	Dimensional drawing → F-123	
					 -	 320 <sup>7)</sup>				

<sup>1)</sup> FC fiber optic fiber cutter included in scope of delivery.

<sup>2)</sup> Minimum detectable object was determined at optimal measuring distance and optimal setting.

<sup>3)</sup> Operating mode: 16 µs. <sup>4)</sup> Operating mode: 70 µs. <sup>5)</sup> Operating mode: 250 µs. <sup>6)</sup> Operating mode: 2 ms. <sup>7)</sup> Operating mode: 8 ms.

<sup>8)</sup> Operating mode: 250 µs (potentiometer). <sup>9)</sup> Operating mode: 50 µs (teach-in). <sup>10)</sup> Operating mode: 250 µs (teach-in).

Fiber optic cables with lengths different to the products shown here are available on request.

**B**

Figure	Length	Min. object diameter <sup>2)</sup>	Bend radius, fiber-optic cable	Ambient temperature, operation	Sensing range with GLL170 in mm		Sensing range with WLL180T in mm		Type	Part no.
	1 m	0.015 mm	25 mm	-40 °C ... +70 °C	-	-	5 <sup>3)</sup>	LL3-DR07	5326007	
					10 <sup>9)</sup>	15 <sup>4)</sup>				
					20 <sup>10)</sup>	35 <sup>5)</sup>				
					-	65 <sup>6)</sup>				
					-	120 <sup>7)</sup>				
Dimensional drawing → F-123										
	2 m <sup>1)</sup>	0.02 mm	1 mm	-40 °C ... +60 °C	40 <sup>8)</sup>	12 <sup>3)</sup>	LL3-DR10	5326005		
					20 <sup>9)</sup>	40 <sup>4)</sup>				
					50 <sup>10)</sup>	77 <sup>5)</sup>				
					-	150 <sup>6)</sup>				
					-	160 <sup>7)</sup>				
Dimensional drawing → F-124										
	500 mm <sup>1)</sup>	0.015 mm	4 mm	-40 °C ... +70 °C	10 <sup>8)</sup>	10 <sup>3)</sup>	LL3-DT02	5308085		
					10 <sup>9)</sup>	30 <sup>4)</sup>				
					30 <sup>10)</sup>	60 <sup>5)</sup>				
					-	140 <sup>6)</sup>				
					-	225 <sup>7)</sup>				
Dimensional drawing → F-125										
	500 mm	0.015 mm	4 mm	-40 °C ... +70 °C	20 <sup>8)</sup>	13 <sup>3)</sup>	LL3-DT04	5308086		
					20 <sup>9)</sup>	45 <sup>4)</sup>				
					40 <sup>10)</sup>	80 <sup>5)</sup>				
					-	140 <sup>6)</sup>				
					-	280 <sup>7)</sup>				
Dimensional drawing → F-125										
		0.015 mm	15 mm	-40 °C ... +70 °C	50 <sup>8)</sup>	10 <sup>3)</sup>	LL3-DT05	5313028		
					40 <sup>9)</sup>	28 <sup>4)</sup>				
					100 <sup>10)</sup>	45 <sup>5)</sup>				
					-	95 <sup>6)</sup>				
					-	170 <sup>7)</sup>				
Dimensional drawing → F-125										
	2 m <sup>1)</sup>	0.025 mm	25 mm	-40 °C ... +70 °C	150 <sup>8)</sup>	40 <sup>3)</sup>	LL3-DV01	5308088		
					200 <sup>9)</sup>	135 <sup>4)</sup>				
					300 <sup>10)</sup>	180 <sup>5)</sup>				
					-	270 <sup>6)</sup>				
					-	330 <sup>7)</sup>				
Dimensional drawing → F-126										
		0.015 mm	15 mm	-40 °C ... +70 °C	20 <sup>8)</sup>	10 <sup>3)</sup>	LL3-DV02	5308089		
					20 <sup>9)</sup>	35 <sup>4)</sup>				
					40 <sup>10)</sup>	70 <sup>5)</sup>				
					-	125 <sup>6)</sup>				
					-	290 <sup>7)</sup>				
Dimensional drawing → F-126										
		0.025 mm	25 mm	-40 °C ... +70 °C	100 <sup>8)</sup>	35 <sup>3)</sup>	LL3-DV03	5308090		
					80 <sup>9)</sup>	135 <sup>4)</sup>				
					170 <sup>10)</sup>	170 <sup>5)</sup>				
					-	290 <sup>6)</sup>				
					-	320 <sup>7)</sup>				
Dimensional drawing → F-126										

<sup>1)</sup> FC fiber optic fiber cutter included in scope of delivery.

<sup>2)</sup> Minimum detectable object was determined at optimal measuring distance and optimal setting.

<sup>3)</sup> Operating mode: 16 µs. <sup>4)</sup> Operating mode: 70 µs. <sup>5)</sup> Operating mode: 250 µs. <sup>6)</sup> Operating mode: 2 ms. <sup>7)</sup> Operating mode: 8 ms.

<sup>8)</sup> Operating mode: 250 µs (potentiometer). <sup>9)</sup> Operating mode: 50 µs (teach-in). <sup>10)</sup> Operating mode: 250 µs (teach-in).

Fiber optic cables with lengths different to the products shown here are available on request.



Long end sleeve, through-beam system

B

Figure	Length	Min. object diameter <sup>2)</sup>	Bend radius, fiber-optic cable	Ambient temperature, operation	Sensing range with GLL170 in mm		Sensing range with WLL180T in mm		Type	Part no.
	2 m <sup>1)</sup>	0.2 mm	25 mm	-40 °C ... +70 °C	550 <sup>8)</sup>	240 <sup>3)</sup>	550 <sup>8)</sup>	240 <sup>3)</sup>	LL3-TB03	5308056
					580 <sup>9)</sup>	700 <sup>4)</sup>				
					1,040 <sup>10)</sup>	1,400 <sup>5)</sup>				
					-	2,500 <sup>6)</sup>				
					-	2,900 <sup>7)</sup>				
Dimensional drawing → F-136										
	2 m <sup>1)</sup>	0.03 mm	25 mm	-40 °C ... +70 °C	220 <sup>8)</sup>	50 <sup>3)</sup>	220 <sup>8)</sup>	50 <sup>3)</sup>	LL3-TB05	5325924
					150 <sup>9)</sup>	140 <sup>4)</sup>				
					260 <sup>10)</sup>	250 <sup>5)</sup>				
					-	500 <sup>6)</sup>				
					-	530 <sup>7)</sup>				
Dimensional drawing → F-136										
	2 m <sup>1)</sup>	0.2 mm	25 mm	-40 °C ... +100 °C	590 <sup>8)</sup>	180 <sup>3)</sup>	590 <sup>8)</sup>	180 <sup>3)</sup>	LL3-TK16	5313038
					530 <sup>9)</sup>	600 <sup>4)</sup>				
					790 <sup>10)</sup>	1,100 <sup>5)</sup>				
					-	2,500 <sup>6)</sup>				
					-	3,300 <sup>7)</sup>				
Dimensional drawing → F-140										
	500 mm	0.02 mm	5 mm	-40 °C ... +70 °C	8 <sup>8)</sup>	2 <sup>3)</sup>	8 <sup>8)</sup>	2 <sup>3)</sup>	LL3-TP01	5325925
					8 <sup>9)</sup>	8 <sup>4)</sup>				
					12 <sup>10)</sup>	14 <sup>5)</sup>				
					-	28 <sup>6)</sup>				
					-	30 <sup>7)</sup>				
Dimensional drawing → F-141										
	2 m <sup>1)</sup>	0.2 mm	25 mm	-40 °C ... +70 °C	410 <sup>8)</sup>	170 <sup>3)</sup>	410 <sup>8)</sup>	170 <sup>3)</sup>	LL3-TS08	5308061
					410 <sup>9)</sup>	500 <sup>4)</sup>				
					710 <sup>10)</sup>	1,000 <sup>5)</sup>				
					-	2,300 <sup>6)</sup>				
					-	3,000 <sup>7)</sup>				
Dimensional drawing → F-143										
	2 m <sup>1)</sup>	0.5 mm	25 mm	-40 °C ... +70 °C	350 <sup>8)</sup>	170 <sup>3)</sup>	350 <sup>8)</sup>	170 <sup>3)</sup>	LL3-TS12	5308062
					350 <sup>9)</sup>	550 <sup>4)</sup>				
					350 <sup>10)</sup>	1,000 <sup>5)</sup>				
					-	2,300 <sup>6)</sup>				
					-	3,000 <sup>7)</sup>				
Dimensional drawing → F-143										
	2 m <sup>1)</sup>	0.1 mm	15 mm	-40 °C ... +70 °C	50 <sup>8)</sup>	10 <sup>3)</sup>	50 <sup>8)</sup>	10 <sup>3)</sup>	LL3-TT01	5308057
					30 <sup>9)</sup>	30 <sup>4)</sup>				
					60 <sup>10)</sup>	60 <sup>5)</sup>				
					-	140 <sup>6)</sup>				
					-	200 <sup>7)</sup>				
Dimensional drawing → F-144										
	2 m <sup>1)</sup>	0.2 mm	25 mm	-40 °C ... +70 °C	270 <sup>8)</sup>	120 <sup>3)</sup>	270 <sup>8)</sup>	120 <sup>3)</sup>	LL3-TV01	5308058
					250 <sup>9)</sup>	400 <sup>4)</sup>				
					440 <sup>10)</sup>	800 <sup>5)</sup>				
					-	1,800 <sup>6)</sup>				
					-	2,750 <sup>7)</sup>				
Dimensional drawing → F-144										


















<sup>1)</sup> FC fiber optic fiber cutter included in scope of delivery.

<sup>2)</sup> Minimum detectable object was determined at optimal measuring distance and optimal setting.

<sup>3)</sup> Operating mode: 16 µs. <sup>4)</sup> Operating mode: 70 µs. <sup>5)</sup> Operating mode: 250 µs. <sup>6)</sup> Operating mode: 2 ms. <sup>7)</sup> Operating mode: 8 ms.

<sup>8)</sup> Operating mode: 250 µs (potentiometer). <sup>9)</sup> Operating mode: 50 µs (teach-in). <sup>10)</sup> Operating mode: 250 µs (teach-in).

Fiber optic cables with lengths different to the products shown here are available on request.

Figure	Length	Min. object diameter <sup>2)</sup>	Bend radius, fiber-optic cable	Ambient temperature, operation	Sensing range with GLL170 in mm		Sensing range with WLL180T in mm		Type	Part no.				
	2 m <sup>1)</sup>	0.1 mm	15 mm	-40 °C ... +70 °C		110 <sup>8)</sup>		30 <sup>3)</sup>	LL3-TV02	5308059				
						90 <sup>9)</sup>		130 <sup>4)</sup>						
						170 <sup>10)</sup>		250 <sup>5)</sup>						
					-	-		550 <sup>6)</sup>						
												800 <sup>7)</sup>	Dimensional drawing → <a href="#">F-144</a>	
						80 <sup>8)</sup>		30 <sup>3)</sup>	LL3-TV04	5308060				
						110 <sup>9)</sup>		130 <sup>4)</sup>						
						170 <sup>10)</sup>		250 <sup>5)</sup>						
					-	-		550 <sup>6)</sup>						
												800 <sup>7)</sup>	Dimensional drawing → <a href="#">F-144</a>	

<sup>1)</sup> FC fiber optic fiber cutter included in scope of delivery.

<sup>2)</sup> Minimum detectable object was determined at optimal measuring distance and optimal setting.

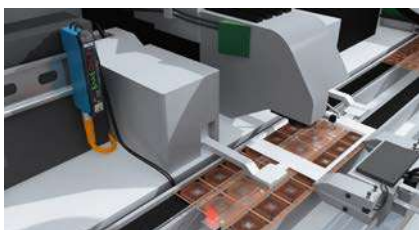
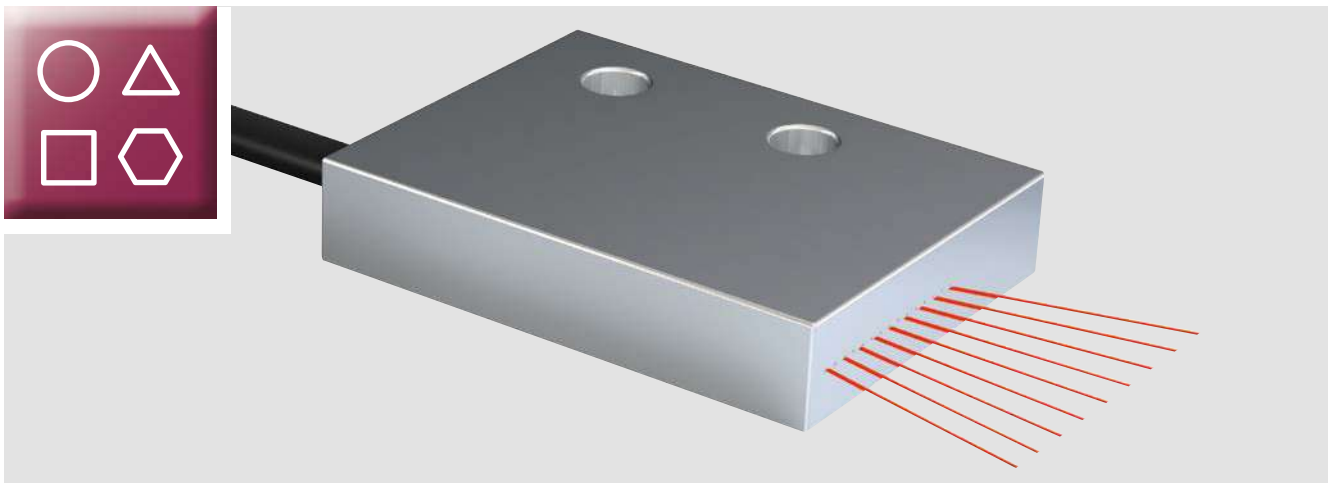
<sup>3)</sup> Operating mode: 16 µs. <sup>4)</sup> Operating mode: 70 µs. <sup>5)</sup> Operating mode: 250 µs. <sup>6)</sup> Operating mode: 2 ms. <sup>7)</sup> Operating mode: 8 ms.

<sup>8)</sup> Operating mode: 250 µs (potentiometer). <sup>9)</sup> Operating mode: 50 µs (teach-in). <sup>10)</sup> Operating mode: 250 µs (teach-in).

Fiber optic cables with lengths different to the products shown here are available on request.

**B**

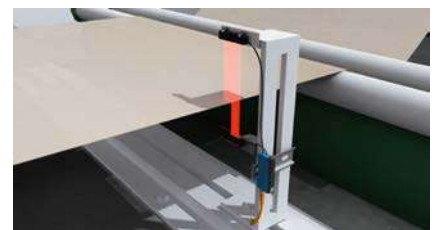
B



Detection of lead frames



Detection of free falling tablets



Monitoring of web edges



Counting pieces on a conveyor



Leading edge detection for PCBs

### Area detection

Area detection fibers are ideal for detecting objects at any point in the light array and for comparing height differences. Optional mask for limiting the detection area enable even very small objects to be detected.



### Area detection, proximity system

Figure	Length	Min. object diameter <sup>2)</sup>	Bend radius, fiber-optic cable	Ambient temperature, operation	Sensing range with GLL170 in mm		Sensing range with WLL180T in mm		Type	Part no.
	2 m <sup>1)</sup>	0.02 mm	25 mm	-40 °C ... +60 °C		130 <sup>8)</sup>		65 <sup>3)</sup>	LL3-DZ01	5326013
						160 <sup>9)</sup>		240 <sup>4)</sup>		
						230 <sup>10)</sup>		320 <sup>5)</sup>		
						-		650 <sup>6)</sup>		
						-		690 <sup>7)</sup>		
Dimensional drawing → F-127										

<sup>1)</sup> FC fiber optic fiber cutter included in scope of delivery.



















<sup>2)</sup> Minimum detectable object was determined at optimal measuring distance and optimal setting.

<sup>3)</sup> Operating mode: 16 µs. <sup>4)</sup> Operating mode: 70 µs. <sup>5)</sup> Operating mode: 250 µs. <sup>6)</sup> Operating mode: 2 ms. <sup>7)</sup> Operating mode: 8 ms.

<sup>8)</sup> Operating mode: 250 µs (potentiometer). <sup>9)</sup> Operating mode: 50 µs (teach-in). <sup>10)</sup> Operating mode: 250 µs (teach-in).

Fiber optic cables with lengths different to the products shown here are available on request.



Figure	Length	Min. object diameter <sup>2)</sup>	Bend radius, fiber-optic cable	Ambient temperature, operation	Sensing range with GLL170 in mm		Sensing range with WLL180T in mm		Type	Part no.
	2 m <sup>1)</sup>	0.02 mm	25 mm	-40 °C ... +70 °C	 210 <sup>8)</sup>	 57 <sup>3)</sup>	LL3-DZ02	5326014		
					 120 <sup>9)</sup>	 190 <sup>4)</sup>				
					 220 <sup>10)</sup>	 310 <sup>5)</sup>				
					-	 630 <sup>6)</sup>				
					-	 670 <sup>7)</sup>				
					-	-				
					 170 <sup>8)</sup>	 50 <sup>3)</sup>	LL3-DZ03	5326015		
					 100 <sup>9)</sup>	 160 <sup>4)</sup>				
					 200 <sup>10)</sup>	 280 <sup>5)</sup>				
					-	 450 <sup>6)</sup>				
					-	 590 <sup>7)</sup>				
					-	-				
Dimensional drawing → <a href="#">F-127</a>										
Dimensional drawing → <a href="#">F-127</a>										

<sup>1)</sup> FC fiber optic fiber cutter included in scope of delivery.

<sup>2)</sup> Minimum detectable object was determined at optimal measuring distance and optimal setting.

<sup>3)</sup> Operating mode: 16 µs. <sup>4)</sup> Operating mode: 70 µs. <sup>5)</sup> Operating mode: 250 µs. <sup>6)</sup> Operating mode: 2 ms. <sup>7)</sup> Operating mode: 8 ms.

<sup>8)</sup> Operating mode: 250 µs (potentiometer). <sup>9)</sup> Operating mode: 50 µs (teach-in). <sup>10)</sup> Operating mode: 250 µs (teach-in).

Fiber optic cables with lengths different to the products shown here are available on request.



Area detection, through-beam system

B

Figure	Length	Min. object diameter <sup>2)</sup>	Bend radius, fiber-optic cable	Ambient temperature, operation	Sensing range with GLL170 in mm		Sensing range with WLL180T in mm		Type	Part no.
		1 mm	25 mm	-40 °C ... +70 °C		220 <sup>8)</sup>		130 <sup>3)</sup>	LL3-TS10	5308063
						230 <sup>9)</sup>		400 <sup>4)</sup>		
						370 <sup>10)</sup>		800 <sup>5)</sup>		
					-	-		2,000 <sup>6)</sup>		
					-	-		3,500 <sup>7)</sup>		
Dimensional drawing → F-143										
		0.5 mm	25 mm	-40 °C ... +70 °C		450 <sup>8)</sup>		130 <sup>3)</sup>	LL3-TS14	5313039
						430 <sup>9)</sup>		400 <sup>4)</sup>		
						1,050 <sup>10)</sup>		800 <sup>5)</sup>		
					-	-		2,000 <sup>6)</sup>		
					-	-		3,500 <sup>7)</sup>		
Dimensional drawing → F-143										
		0.4 mm	2 mm	-40 °C ... +60 °C		350 <sup>8)</sup>		3,000 <sup>3)</sup>	LL3-TS40	5323971
						350 <sup>9)</sup>		4,000 <sup>4)</sup>		
						350 <sup>10)</sup>		4,000 <sup>5)</sup>		
					-	-		4,000 <sup>6)</sup>		
					-	-		4,000 <sup>7)</sup>		
Dimensional drawing → F-144										
	2 m <sup>1)</sup>	0.45 mm	25 mm	-40 °C ... +70 °C		440 <sup>8)</sup>		150 <sup>3)</sup>	LL3-TZ05	5325937
						400 <sup>9)</sup>		450 <sup>4)</sup>		
						680 <sup>10)</sup>		740 <sup>5)</sup>		
					-	-		1,400 <sup>6)</sup>		
					-	-		1,500 <sup>7)</sup>		
Dimensional drawing → F-146										
		0.45 mm	25 mm	-40 °C ... +70 °C		550 <sup>8)</sup>		150 <sup>3)</sup>	LL3-TZ06	5325938
						480 <sup>9)</sup>		480 <sup>4)</sup>		
						670 <sup>10)</sup>		790 <sup>5)</sup>		
					-	-		1,500 <sup>6)</sup>		
					-	-		1,600 <sup>7)</sup>		
Dimensional drawing → F-146										
		0.25 mm	1 mm	-40 °C ... +55 °C		2,000 <sup>8)</sup>		1,300 <sup>3)</sup>	LL3-TZ09	5326598
						2,000 <sup>9)</sup>		2,500 <sup>4)</sup>		
						2,500 <sup>10)</sup>		3,000 <sup>5)</sup>		
					-	-		3,500 <sup>6)</sup>		
					-	-		4,000 <sup>7)</sup>		
Dimensional drawing → F-146										
		0.25 mm	10 mm	-40 °C ... +70 °C		2,500 <sup>8)</sup>		1,700 <sup>3)</sup>	LL3-TZ10	5326599
						2,000 <sup>9)</sup>		2,500 <sup>4)</sup>		
						2,500 <sup>10)</sup>		3,000 <sup>5)</sup>		
					-	-		3,500 <sup>6)</sup>		
					-	-		4,000 <sup>7)</sup>		
Dimensional drawing → F-147										

<sup>1)</sup> FC fiber optic fiber cutter included in scope of delivery.

<sup>2)</sup> Minimum detectable object was determined at optimal measuring distance and optimal setting.

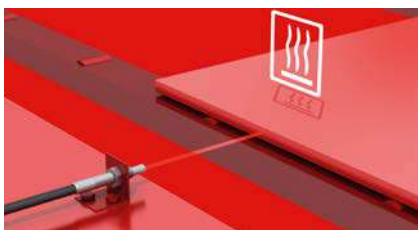
<sup>3)</sup> Operating mode: 16 µs. <sup>4)</sup> Operating mode: 70 µs. <sup>5)</sup> Operating mode: 250 µs. <sup>6)</sup> Operating mode: 2 ms. <sup>7)</sup> Operating mode: 8 ms.

<sup>8)</sup> Operating mode: 250 µs (potentiometer). <sup>9)</sup> Operating mode: 50 µs (teach-in). <sup>10)</sup> Operating mode: 250 µs (teach-in).

Fiber optic cables with lengths different to the products shown here are available on request.



**B**



Detection in an oven

### Heat-resistant

An extensive range of heat-resistant fibers meet every requirement. These fibers can withstand ambient temperatures of up to 350 °C. The fiber-optic material for fibers used in ambient temperatures of up to +180 °C is plastic; for temperatures above +200 °C it is glass.



### Heat resistant, proximity system

Figure	Length	Min. object diameter <sup>2)</sup>	Bend radius, fiber-optic cable	Ambient temperature, operation	Sensing range with GLL170 in mm		Sensing range with WLL180T in mm		Type	Part no.
	2 m <sup>1)</sup>	0.015 mm	35 mm	-40 °C ... +180 °C		150 <sup>8)</sup>		120 <sup>3)</sup>	LL3-DH01	5308091
						180 <sup>9)</sup>		350 <sup>4)</sup>		
						320 <sup>10)</sup>		600 <sup>5)</sup>		
						980 <sup>6)</sup>		1,500 <sup>7)</sup>		
					-		-			
	3 m <sup>1)</sup>	0.015 mm	35 mm	-40 °C ... +180 °C		210 <sup>8)</sup>		100 <sup>3)</sup>	LL3-DH01-03	5321260
						180 <sup>9)</sup>		300 <sup>4)</sup>		
						330 <sup>10)</sup>		500 <sup>5)</sup>		
						850 <sup>6)</sup>		1,400 <sup>7)</sup>		
					-		-			

<sup>1)</sup> FC fiber optic fiber cutter included in scope of delivery.

<sup>2)</sup> Minimum detectable object was determined at optimal measuring distance and optimal setting.




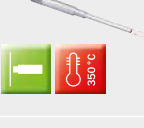


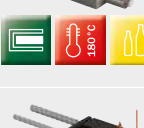

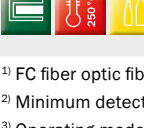
<sup>3)</sup> Operating mode: 16 μs. <sup>4)</sup> Operating mode: 70 μs. <sup>5)</sup> Operating mode: 250 μs. <sup>6)</sup> Operating mode: 2 ms. <sup>7)</sup> Operating mode: 8 ms.

<sup>8)</sup> Operating mode: 250 μs (potentiometer). <sup>9)</sup> Operating mode: 50 μs (teach-in). <sup>10)</sup> Operating mode: 250 μs (teach-in).

<sup>11)</sup> Humidity/level detection only in conjunction with WLL180T-P474 IR version.

Fiber optic cables with lengths different to the products shown here are available on request.

B

Figure	Length	Min. object diameter <sup>2)</sup>	Bend radius, fiber-optic cable	Ambient temperature, operation	Sensing range with GLL170 in mm		Sensing range with WLL180T in mm		Type	Part no.
	2 m <sup>1)</sup>	0.015 mm	25 mm	-40 °C ... +100 °C	90 <sup>8)</sup>	70 <sup>3)</sup>	LL3-DH02	5308092		
					110 <sup>9)</sup>	230 <sup>4)</sup>				
	2 m	0.02 mm	25 mm	-30 °C ... +350 °C	220 <sup>10)</sup>	350 <sup>5)</sup>	LL3-DH03	5324787		
					230 <sup>8)</sup>	55 <sup>3)</sup>				
	2 m	0.02 mm	25 mm	-30 °C ... +350 °C	350 <sup>10)</sup>	490 <sup>5)</sup>	LL3-DH04	5326022		
					140 <sup>9)</sup>	220 <sup>4)</sup>				
	1 m	0.02 mm	25 mm	-30 °C ... +350 °C	150 <sup>8)</sup>	65 <sup>3)</sup>	LL3-DH05	5326021		
					150 <sup>9)</sup>	225 <sup>4)</sup>				
	2 m	0.02 mm	25 mm	-30 °C ... +300 °C	360 <sup>10)</sup>	500 <sup>5)</sup>	LL3-DH06	5326026		
					290 <sup>8)</sup>	55 <sup>3)</sup>				
	1 m	0.02 mm	25 mm	-60 °C ... +200 °C	30 <sup>10)</sup>	19 <sup>5)</sup>	LL3-DH07	5326031		
					14 <sup>8)</sup>	5 <sup>3)</sup>				
	2 m <sup>1)</sup>	0.02 mm	25 mm	-60 °C ... +180 °C	20 <sup>9)</sup>	10 <sup>4)</sup>	LL3-DH08	5326025		
					30 <sup>10)</sup>	19 <sup>5)</sup>				
	3 m	0.02 mm	25 mm	-20 °C ... +250 °C	37 <sup>6)</sup>	43 <sup>7)</sup>	LL3-DH10	5326023		
					16.8 <sup>8)</sup>	11 <sup>3)</sup>				
	3 m	0.02 mm	25 mm	-20 °C ... +250 °C	9 <sup>9)</sup>	18 <sup>4)</sup>	LL3-DH11	5326024		
					12 <sup>10)</sup>	22 <sup>5)</sup>				
					26 <sup>8)</sup>	19 <sup>3)</sup>				
					14.5 <sup>9)</sup>	29 <sup>4)</sup>				
					19 <sup>10)</sup>	34 <sup>5)</sup>				
					-	39 <sup>6)</sup>				
					-	42 <sup>7)</sup>				

<sup>1)</sup> FC fiber optic fiber cutter included in scope of delivery.










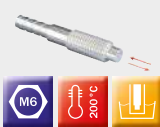

















<sup>2)</sup> Minimum detectable object was determined at optimal measuring distance and optimal setting.

<sup>3)</sup> Operating mode: 16 µs. <sup>4)</sup> Operating mode: 70 µs. <sup>5)</sup> Operating mode: 250 µs. <sup>6)</sup> Operating mode: 2 ms. <sup>7)</sup> Operating mode: 8 ms.

<sup>8)</sup> Operating mode: 250 µs (potentiometer). <sup>9)</sup> Operating mode: 50 µs (teach-in). <sup>10)</sup> Operating mode: 250 µs (teach-in).

<sup>11)</sup> Humidity/level detection only in conjunction with WLL180T-P474 IR version.

Fiber optic cables with lengths different to the products shown here are available on request.

Figure	Length	Min. object diameter <sup>2)</sup>	Bend radius, fiber-optic cable	Ambient temperature, operation	Sensing range with GLL170 in mm		Sensing range with WLL180T in mm		Type	Part no.
	2 m <sup>1)</sup>	0.015 mm	25 mm	-40 °C ... +105 °C	 50 <sup>8)</sup>	 30 <sup>3)</sup>	LL3-DV06	5322550		
					 70 <sup>9)</sup>	 130 <sup>4)</sup>				
					 120 <sup>10)</sup>	 210 <sup>5)</sup>				
					-	 450 <sup>6)</sup>				
					-	 800 <sup>7)</sup>				
Dimensional drawing → F-126										
	1 m	0.02 mm	25 mm	-40 °C ... +210 °C	 142 <sup>8)</sup>	 20 <sup>3)</sup>	LL3-DW01 <sup>11)</sup>	5315234		
					 206 <sup>9)</sup>	 50 <sup>4)</sup>				
					 323 <sup>10)</sup>	 95 <sup>5)</sup>				
					-	 150 <sup>6)</sup>				
					-	 400 <sup>7)</sup>				
Dimensional drawing → F-126										
	2 m	0.02 mm	25 mm	-40 °C ... +210 °C	 153 <sup>8)</sup>	 20 <sup>3)</sup>	LL3-DW01-2 <sup>11)</sup>	5324789		
					 230 <sup>9)</sup>	 50 <sup>4)</sup>				
					 352 <sup>10)</sup>	 95 <sup>5)</sup>				
					-	 150 <sup>6)</sup>				
					-	 400 <sup>7)</sup>				
Dimensional drawing → F-127										

<sup>1)</sup> FC fiber optic fiber cutter included in scope of delivery.

<sup>2)</sup> Minimum detectable object was determined at optimal measuring distance and optimal setting.

<sup>3)</sup> Operating mode: 16 µs. <sup>4)</sup> Operating mode: 70 µs. <sup>5)</sup> Operating mode: 250 µs. <sup>6)</sup> Operating mode: 2 ms. <sup>7)</sup> Operating mode: 8 ms.

<sup>8)</sup> Operating mode: 250 µs (potentiometer). <sup>9)</sup> Operating mode: 50 µs (teach-in). <sup>10)</sup> Operating mode: 250 µs (teach-in).

<sup>11)</sup> Humidity/level detection only in conjunction with WLL180T-P474 IR version.

Fiber optic cables with lengths different to the products shown here are available on request.

**B**



Heat resistant, through-beam system

B

Figure	Length	Min. object diameter <sup>2)</sup>	Bend radius, fiber-optic cable	Ambient temperature, operation	Sensing range with GLL170 in mm		Sensing range with WLL180T in mm		Type	Part no.
   Suitable for tip adapters	2 m <sup>1)</sup>	0.2 mm	25 mm	-40 °C ... +100 °C	410 <sup>8)</sup>	55 <sup>3)</sup>	LL3-TH01	5308064		
					340 <sup>9)</sup>	180 <sup>4)</sup>				
  	2 m	0.5 mm	35 mm	-40 °C ... +180 °C	580 <sup>10)</sup>	320 <sup>5)</sup>	LL3-TH02	5308065	Dimensional drawing → F-138	
					-	680 <sup>6)</sup>				
  	2 m	0.1 mm	50 mm	-60 °C ... +200 °C	460 <sup>8)</sup>	230 <sup>3)</sup>	LL3-TH07	5325977	Dimensional drawing → F-138	
					460 <sup>9)</sup>	700 <sup>4)</sup>				
 	1 m	0.04 mm	25 mm	-30 °C ... +350 °C	780 <sup>10)</sup>	1,300 <sup>5)</sup>	LL3-TH08	5325978	Dimensional drawing → F-138	
					-	2,700 <sup>6)</sup>				
 	1 m	0.04 mm	25 mm	-30 °C ... +350 °C	-	420 <sup>7)</sup>	LL3-TH09	5325979	Dimensional drawing → F-138	
					60 <sup>8)</sup>	18 <sup>3)</sup>				
 	1 m	0.02 mm	10 mm	-60 °C ... +200 °C	50 <sup>9)</sup>	30 <sup>4)</sup>	LL3-TH10	5325970	Dimensional drawing → F-139	
					90 <sup>10)</sup>	120 <sup>5)</sup>				
 	1 m	0.04 mm	25 mm	-60 °C ... +200 °C	-	220 <sup>6)</sup>	LL3-TH11	5325971	Dimensional drawing → F-139	
					-	400 <sup>7)</sup>				

<sup>1)</sup> FC fiber optic fiber cutter included in scope of delivery.

<sup>2)</sup> Minimum detectable object was determined at optimal measuring distance and optimal setting.

<sup>3)</sup> Operating mode: 16 μs. <sup>4)</sup> Operating mode: 70 μs. <sup>5)</sup> Operating mode: 250 μs. <sup>6)</sup> Operating mode: 2 ms. <sup>7)</sup> Operating mode: 8 ms.

<sup>8)</sup> Operating mode: 250 μs (potentiometer). <sup>9)</sup> Operating mode: 50 μs (teach-in). <sup>10)</sup> Operating mode: 250 μs (teach-in).

<sup>11)</sup> Humidity/level detection only in conjunction with WLL180T-P474 IR version.

Fiber optic cables with lengths different to the products shown here are available on request.

**B**

Figure	Length	Min. object diameter <sup>2)</sup>	Bend radius, fiber-optic cable	Ambient temperature, operation	Sensing range with GLL170 in mm		Sensing range with WLL180T in mm		Type	Part no.
		0.12 mm	25 mm	-60 °C ... +200 °C	410 <sup>8)</sup>	100 <sup>3)</sup>	LL3-TH12	5325972		
					330 <sup>9)</sup>	330 <sup>4)</sup>				
					490 <sup>10)</sup>	570 <sup>5)</sup>				
					-	1,100 <sup>6)</sup>				
					-	1,200 <sup>7)</sup>				
Dimensional drawing → F-139										
		0.12 mm	25 mm	-60 °C ... +200 °C	270 <sup>8)</sup>	100 <sup>3)</sup>	LL3-TH13	5325973		
					330 <sup>9)</sup>	330 <sup>4)</sup>				
					490 <sup>10)</sup>	570 <sup>5)</sup>				
					-	1,100 <sup>6)</sup>				
					-	1,200 <sup>7)</sup>				
Dimensional drawing → F-139										
		0.12 mm	25 mm	-60 °C ... +200 °C	270 <sup>8)</sup>	100 <sup>3)</sup>	LL3-TH14	5325974		
					330 <sup>9)</sup>	330 <sup>4)</sup>				
					490 <sup>10)</sup>	570 <sup>5)</sup>				
					-	1,100 <sup>6)</sup>				
					-	1,200 <sup>7)</sup>				
Dimensional drawing → F-139										
	2 m <sup>1)</sup>	0.16 mm	25 mm	-60 °C ... +200 °C	270 <sup>8)</sup>	90 <sup>3)</sup>	LL3-TH15	5325975		
					290 <sup>9)</sup>	290 <sup>4)</sup>				
					410 <sup>10)</sup>	480 <sup>5)</sup>				
					-	970 <sup>6)</sup>				
					-	1,000 <sup>7)</sup>				
Dimensional drawing → F-139										
		0.16 mm	25 mm	-60 °C ... +200 °C	270 <sup>8)</sup>	90 <sup>3)</sup>	LL3-TH16	5325976		
					290 <sup>9)</sup>	290 <sup>4)</sup>				
					410 <sup>10)</sup>	480 <sup>5)</sup>				
					-	970 <sup>6)</sup>				
					-	1,000 <sup>7)</sup>				
Dimensional drawing → F-140										
		-	10 mm	-40 °C ... +105 °C	1,190 <sup>8)</sup>	220 <sup>3)</sup>	LL3-TS22M	5325968		
					1,040 <sup>9)</sup>	760 <sup>4)</sup>				
					1,740 <sup>10)</sup>	1,500 <sup>5)</sup>				
					-	2,900 <sup>6)</sup>				
					-	4,000 <sup>7)</sup>				
Dimensional drawing → F-144										
		0.4 mm	25 mm	-40 °C ... +105 °C	560 <sup>8)</sup>	180 <sup>3)</sup>	LL3-TV06	5322547		
					460 <sup>9)</sup>	550 <sup>4)</sup>				
					680 <sup>10)</sup>	900 <sup>5)</sup>				
					-	2,100 <sup>6)</sup>				
					-	3,500 <sup>7)</sup>				
Dimensional drawing → F-144										
	1 m	0.4 mm	25 mm	-40 °C ... +210 °C	556 <sup>8)</sup>	80 <sup>3)</sup>	LL3-TW01 <sup>11)</sup>	5315233		
					866 <sup>9)</sup>	230 <sup>4)</sup>				
					1,435 <sup>10)</sup>	350 <sup>5)</sup>				
					-	560 <sup>6)</sup>				
					-	980 <sup>7)</sup>				
Dimensional drawing → F-145										
	2 m	0.4 mm	25 mm	-40 °C ... +210 °C	534 <sup>8)</sup>	80 <sup>3)</sup>	LL3-TW01-2 <sup>11)</sup>	5321306		
					821 <sup>9)</sup>	230 <sup>4)</sup>				
					1,393 <sup>10)</sup>	350 <sup>5)</sup>				
					-	560 <sup>6)</sup>				
					-	980 <sup>7)</sup>				
Dimensional drawing → F-145										

<sup>1)</sup> FC fiber optic fiber cutter included in scope of delivery.

<sup>2)</sup> Minimum detectable object was determined at optimal measuring distance and optimal setting.

<sup>3)</sup> Operating mode: 16 µs. <sup>4)</sup> Operating mode: 70 µs. <sup>5)</sup> Operating mode: 250 µs. <sup>6)</sup> Operating mode: 2 ms. <sup>7)</sup> Operating mode: 8 ms.

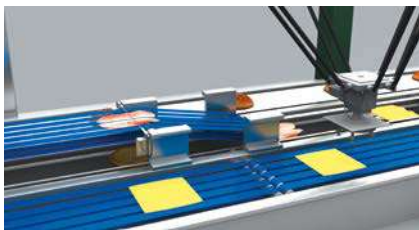
<sup>8)</sup> Operating mode: 250 µs (potentiometer). <sup>9)</sup> Operating mode: 50 µs (teach-in). <sup>10)</sup> Operating mode: 250 µs (teach-in).

<sup>11)</sup> Humidity/level detection only in conjunction with WLL180T-P474 IR version.

Fiber optic cables with lengths different to the products shown here are available on request.



B



Detection of meat products in the food industry



Wafer detection in wet process

### Oil/chemical resistant

Applications in areas involving frequent cleaning or use of chemicals require a solution with durable fibers. Fibers with a PTFE sheath are ideal for almost every environment.



### Oil/chemical resistant, proximity system

Figure	Length	Min. object diameter <sup>1)</sup>	Bend radius, fiber-optic cable	Ambient temperature, operation	Sensing range with GLL170 in mm		Sensing range with WLL180T in mm		Type	Part no.
	2 m	0.02 mm	60 mm	-40 °C ... +100 °C		110 <sup>7)</sup>		100 <sup>2)</sup>	LL3-DY01	5308093
						160 <sup>8)</sup>		180 <sup>3)</sup>		
						150 <sup>9)</sup>		200 <sup>4)</sup>		
						-		150 <sup>5)</sup>		
						-		280 <sup>6)</sup>		
Dimensional drawing → <a href="#">F-127</a>										

<sup>1)</sup> Minimum detectable object was determined at optimal measuring distance and optimal setting.

<sup>2)</sup> Operating mode: 16 µs. <sup>3)</sup> Operating mode: 70 µs. <sup>4)</sup> Operating mode: 250 µs. <sup>5)</sup> Operating mode: 2 ms. <sup>6)</sup> Operating mode: 8 ms.

<sup>7)</sup> Operating mode: 250 µs (potentiometer). <sup>8)</sup> Operating mode: 50 µs (teach-in). <sup>9)</sup> Operating mode: 250 µs (teach-in).

Fiber optic cables with lengths different to the products shown here are available on request.



Oil/chemical resistant, through-beam system

Figure	Length	Min. object diameter <sup>2)</sup>	Bend radius, fiber-optic cable	Ambient temperature, operation	Sensing range with GLL170 in mm		Sensing range with WLL180T in mm		Type	Part no.
	2 m	0.3 mm	60 mm	-40 °C ... +70 °C	870 <sup>8)</sup>	400 <sup>3)</sup>	LL3-TY01	5308066		
					800 <sup>9)</sup>	1,200 <sup>4)</sup>				
					1,370 <sup>10)</sup>	2,100 <sup>5)</sup>				
					-	4,000 <sup>6)</sup>				
					-	4,000 <sup>7)</sup>				
	2 m	0.3 mm	60 mm	-40 °C ... +70 °C	730 <sup>8)</sup>	300 <sup>3)</sup>	LL3-TY02	5308067		
					800 <sup>9)</sup>	1,000 <sup>4)</sup>				
					940 <sup>10)</sup>	1,300 <sup>5)</sup>				
					-	3,000 <sup>6)</sup>				
					-	4,000 <sup>7)</sup>				
	3 m <sup>1)</sup>	0.3 mm	20 mm	-55 °C ... +70 °C	1,290 <sup>8)</sup>	460 <sup>3)</sup>	LL3-TY03	5325982		
					1,210 <sup>9)</sup>	1,400 <sup>4)</sup>				
					2,120 <sup>10)</sup>	2,500 <sup>5)</sup>				
					-	4,000 <sup>6)</sup>				
					-	4,000 <sup>7)</sup>				
	2 m <sup>1)</sup>	4 mm	25 mm	0 °C ... +60 °C	1,920 <sup>8)</sup>	850 <sup>3)</sup>	LL3-TY05	5325980		
					1,150 <sup>9)</sup>	2,700 <sup>4)</sup>				
					1,820 <sup>10)</sup>	3,000 <sup>5)</sup>				
					-	4,000 <sup>6)</sup>				
					-	4,000 <sup>7)</sup>				

<sup>1)</sup> FC fiber optic fiber cutter included in scope of delivery.

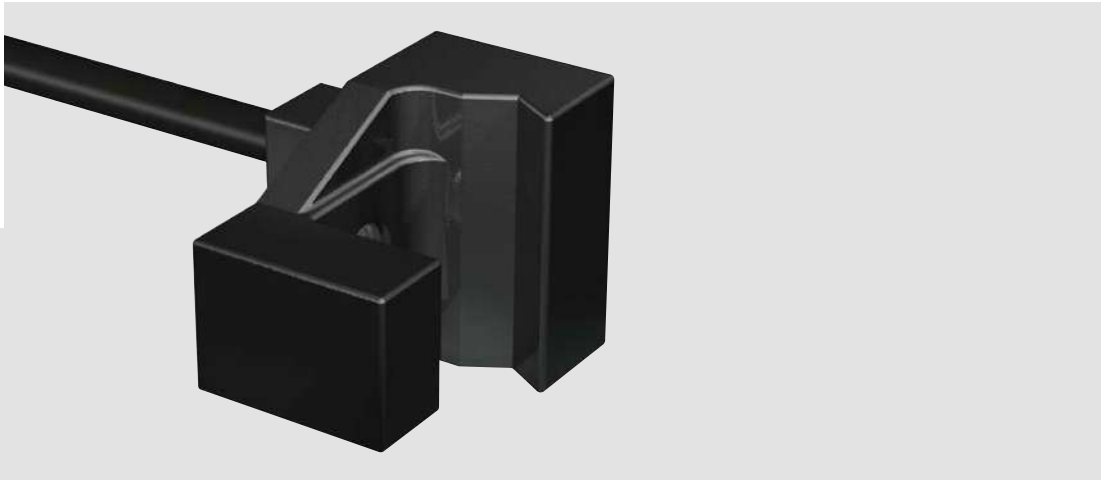
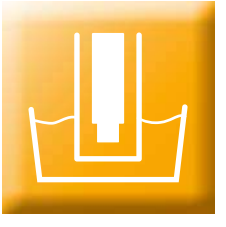
<sup>2)</sup> Minimum detectable object was determined at optimal measuring distance and optimal setting.

<sup>3)</sup> Operating mode: 16 µs. <sup>4)</sup> Operating mode: 70 µs. <sup>5)</sup> Operating mode: 250 µs. <sup>6)</sup> Operating mode: 2 ms. <sup>7)</sup> Operating mode: 8 ms.

<sup>8)</sup> Operating mode: 250 µs (potentiometer). <sup>9)</sup> Operating mode: 50 µs (teach-in). <sup>10)</sup> Operating mode: 250 µs (teach-in).

Fiber optic cables with lengths different to the products shown here are available on request.

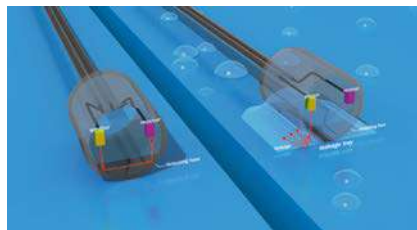
**B**



B



Level detection through immersion using LL3-DF02



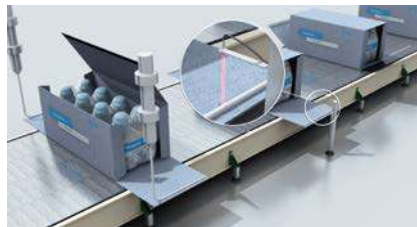
Leak detection (LL3-DW02)



Non-contact level detection using LL3-TW01 (in conjunction with IR sensor)



Level detection on a pipe (LL3-DF07)







Detection of an adhesive strip (humidity detection) using LL3-DW01 and WLL180T IR

### Liquid level

A variety of fiber optic solutions are available for detecting liquids and liquid levels. Liquid levels can be detected by immersion or tube mounting of a sender/receiver system. Special fibers are available for leak detection.



Liquid level, proximity system

Figure	Length	Min. object diameter <sup>2)</sup>	Bend radius, fiber-optic cable	Ambient temperature, operation	Sensing range with GLL170 in mm		Sensing range with WLL180T in mm		Type	Part no.
	2 m <sup>1)</sup>	-	30 mm	-40 °C ... +105 °C	-	-	-	-	LL3-DF02-S01	5321924
					-	-	-	-		
					-	-	-	-		
					-	-	-	-		
Dimensional drawing → F-118										
	2 m <sup>1)</sup>	-	10 mm	-40 °C ... +100 °C	-	-	-	-	LL3-DF04	5326035
					-	-	-	-		
					-	-	-	-		
					-	-	-	-		
Dimensional drawing → F-118										
	2 m <sup>1)</sup>	-	10 mm	-40 °C ... +100 °C	-	-	-	-	LL3-DF05	5326034
					-	-	-	-		
					-	-	-	-		
					-	-	-	-		
Dimensional drawing → F-118										
	-	-	-	-40 °C ... +70 °C	-	-	-	-	LL3-DF07	5326033
					-	-	-	-		
					-	-	-	-		
					-	-	-	-		
Dimensional drawing → F-119										
	1 m	0.02 mm	25 mm	-40 °C ... +210 °C	■	142 <sup>8)</sup>	■	20 <sup>3)</sup>	LL3-DW01 <sup>11)</sup>	5315234
					■	206 <sup>9)</sup>	■	50 <sup>4)</sup>		
					■	323 <sup>10)</sup>	■	95 <sup>5)</sup>		
					-	-	■	150 <sup>6)</sup>		
Dimensional drawing → F-126										
	2 m	0.02 mm	25 mm	-40 °C ... +210 °C	■	153 <sup>8)</sup>	■	20 <sup>3)</sup>	LL3-DW01-2 <sup>11)</sup>	5324789
					■	230 <sup>9)</sup>	■	50 <sup>4)</sup>		
					■	352 <sup>10)</sup>	■	95 <sup>5)</sup>		
					-	-	■	150 <sup>6)</sup>		
Dimensional drawing → F-127										
	5 m	-	20 mm	-20 °C ... +50 °C	-	-	-	-	LL3-DW02	5325608
					-	-	-	-		
					-	-	-	-		
					-	-	-	-		
Dimensional drawing → F-127										

<sup>1)</sup> FC fiber optic fiber cutter included in scope of delivery.

<sup>2)</sup> Minimum detectable object was determined at optimal measuring distance and optimal setting.

<sup>3)</sup> Operating mode: 16 µs. <sup>4)</sup> Operating mode: 70 µs. <sup>5)</sup> Operating mode: 250 µs. <sup>6)</sup> Operating mode: 2 ms. <sup>7)</sup> Operating mode: 8 ms.





































<sup>8)</sup> Operating mode: 250 µs (potentiometer). <sup>9)</sup> Operating mode: 50 µs (teach-in). <sup>10)</sup> Operating mode: 250 µs (teach-in).

<sup>11)</sup> Humidity/level detection only in conjunction with WLL180T-P474 IR version.

Fiber optic cables with lengths different to the products shown here are available on request.

**B**

B

Figure	Length	Min. object diameter <sup>2)</sup>	Bend radius, fiber-optic cable	Ambient temperature, operation	Sensing range with GLL170 in mm		Sensing range with WLL180T in mm		Type	Part no.
	750 mm	0.5 mm	20 mm	-10 °C ... +60 °C	 285 <sup>8)</sup>	 170 <sup>3)</sup>	LL3-LM32750	2073500		
					 485 <sup>9)</sup>	 520 <sup>4)</sup>				
					 811 <sup>10)</sup>	 580 <sup>5)</sup>				
					-	 580 <sup>6)</sup>				
					-	 580 <sup>7)</sup>				
Dimensional drawing → <a href="#">F-128</a>										
	750 mm	0.5 mm	20 mm	-10 °C ... +60 °C	 325 <sup>8)</sup>	 100 <sup>3)</sup>	LL3-LM38750	2073503		
					 592 <sup>9)</sup>	 330 <sup>4)</sup>				
					 992 <sup>10)</sup>	 650 <sup>5)</sup>				
					-	 1,300 <sup>6)</sup>				
					-	 1,350 <sup>7)</sup>				
Dimensional drawing → <a href="#">F-130</a>										
	750 mm	0.5 mm	20 mm	-10 °C ... +60 °C	 465 <sup>8)</sup>	 230 <sup>3)</sup>	LL3-LM38751	2073504		
					 780 <sup>9)</sup>	 690 <sup>4)</sup>				
					 1,321 <sup>10)</sup>	 1,320 <sup>5)</sup>				
					-	 1,350 <sup>6)</sup>				
					-	 1,350 <sup>7)</sup>				
Dimensional drawing → <a href="#">F-131</a>										
	750 mm	0.5 mm	20 mm	-10 °C ... +60 °C	 270 <sup>8)</sup>	 130 <sup>3)</sup>	LL3-LM39750	2073506		
					 441 <sup>9)</sup>	 390 <sup>4)</sup>				
					 742 <sup>10)</sup>	 740 <sup>5)</sup>				
					-	 1,350 <sup>6)</sup>				
					-	 1,350 <sup>7)</sup>				
Dimensional drawing → <a href="#">F-131</a>										

<sup>1)</sup> FC fiber optic fiber cutter included in scope of delivery.

<sup>2)</sup> Minimum detectable object was determined at optimal measuring distance and optimal setting.

<sup>3)</sup> Operating mode: 16 µs. <sup>4)</sup> Operating mode: 70 µs. <sup>5)</sup> Operating mode: 250 µs. <sup>6)</sup> Operating mode: 2 ms. <sup>7)</sup> Operating mode: 8 ms.

<sup>8)</sup> Operating mode: 250 µs (potentiometer). <sup>9)</sup> Operating mode: 50 µs (teach-in). <sup>10)</sup> Operating mode: 250 µs (teach-in).

<sup>11)</sup> Humidity/level detection only in conjunction with WLL180T-P474 IR version.

Fiber optic cables with lengths different to the products shown here are available on request.



Liquid level, through-beam system

Figure	Length	Min. object diameter <sup>1)</sup>	Bend radius, fiber-optic cable	Ambient temperature, operation	Sensing range with GLL170 in mm		Sensing range with WLL180T in mm		Type	Part no.
 	750 mm	0.5 mm	20 mm	-10 °C ... +60 °C	285 <sup>7)</sup>	170 <sup>2)</sup>	LL3-LM32750	2073500		
					485 <sup>8)</sup>	520 <sup>3)</sup>				
					811 <sup>9)</sup>	580 <sup>4)</sup>				
					-	580 <sup>5)</sup>				
					-	580 <sup>6)</sup>				
Dimensional drawing → F-133										
 	750 mm	0.5 mm	20 mm	-10 °C ... +60 °C	325 <sup>7)</sup>	100 <sup>2)</sup>	LL3-LM38750	2073503		
					592 <sup>8)</sup>	330 <sup>3)</sup>				
					992 <sup>9)</sup>	650 <sup>4)</sup>				
					-	1,300 <sup>5)</sup>				
					-	1,350 <sup>6)</sup>				
Dimensional drawing → F-134										
 	750 mm	0.5 mm	20 mm	-10 °C ... +60 °C	465 <sup>7)</sup>	230 <sup>2)</sup>	LL3-LM38751	2073504		
					780 <sup>8)</sup>	690 <sup>3)</sup>				
					1,321 <sup>9)</sup>	1,320 <sup>4)</sup>				
					-	1,350 <sup>5)</sup>				
					-	1,350 <sup>6)</sup>				
Dimensional drawing → F-134										
 	750 mm	0.5 mm	20 mm	-10 °C ... +60 °C	270 <sup>7)</sup>	130 <sup>2)</sup>	LL3-LM39750	2073506		
					441 <sup>8)</sup>	390 <sup>3)</sup>				
					742 <sup>9)</sup>	740 <sup>4)</sup>				
					-	1,350 <sup>5)</sup>				
					-	1,350 <sup>6)</sup>				
Dimensional drawing → F-135										
 	2 m	-	20 mm	-20 °C ... +60 °C	-	-	LL3-TF01	5324242		
					-	-				
					-	-				
					-	-				
					-	-				
Dimensional drawing → F-137										
 	1 m	0.4 mm	25 mm	-40 °C ... +210 °C	556 <sup>7)</sup>	80 <sup>2)</sup>	LL3-TW01 <sup>10)</sup>	5315233		
					866 <sup>8)</sup>	230 <sup>3)</sup>				
					1,435 <sup>9)</sup>	350 <sup>4)</sup>				
					-	560 <sup>5)</sup>				
					-	980 <sup>6)</sup>				
Dimensional drawing → F-145										
 	2 m	0.4 mm	25 mm	-40 °C ... +210 °C	534 <sup>7)</sup>	80 <sup>2)</sup>	LL3-TW01-2 <sup>10)</sup>	5321306		
					821 <sup>8)</sup>	230 <sup>3)</sup>				
					1,393 <sup>9)</sup>	350 <sup>4)</sup>				
					-	560 <sup>5)</sup>				
					-	980 <sup>6)</sup>				
Dimensional drawing → F-145										

<sup>1)</sup> Minimum detectable object was determined at optimal measuring distance and optimal setting.

<sup>2)</sup> Operating mode: 16 µs. <sup>3)</sup> Operating mode: 70 µs. <sup>4)</sup> Operating mode: 250 µs. <sup>5)</sup> Operating mode: 2 ms. <sup>6)</sup> Operating mode: 8 ms.

<sup>7)</sup> Operating mode: 250 µs (potentiometer). <sup>8)</sup> Operating mode: 50 µs (teach-in). <sup>9)</sup> Operating mode: 250 µs (teach-in).

<sup>10)</sup> Humidity/level detection only in conjunction with WLL180T-P474 IR version.

Fiber optic cables with lengths different to the products shown here are available on request.

**B**

B



Indexing with wafers



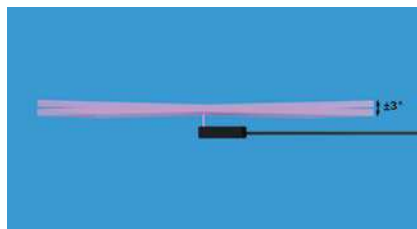
Detection of glass panes, e.g., with LL3-DC38



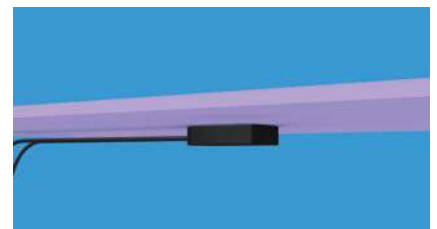
Notch detection



Notch detection, e.g., with LL3-DR09



Safe detection of lead frames, even in a slanted position



LL3-DC39 does not have a blind zone. The lead frame can be detected at a distance of 0 mm.

### LCDS/transparent objects/semiconductors

Fibers with V-optics are ideal for detecting wafers and glass lead frames. They are specially designed to block out background influences.



### LCDS/transparent objects/semiconductors, proximity system

Figure	Length	Min. object diameter <sup>2)</sup>	Bend radius, fiber-optic cable	Ambient temperature, operation	Sensing range with GLL170 in mm		Sensing range with WLL180T in mm		Type	Part no.
	4 m <sup>1)</sup> 	0.3 mm	25 mm	-40 °C ... +60 °C		48 <sup>8)</sup>		60 <sup>3)</sup>	LL3-DC03	5326020
						48 <sup>9)</sup>		75 <sup>4)</sup>		
						64 <sup>10)</sup>		85 <sup>5)</sup>		
						-		150 <sup>6)</sup>		
						-		280 <sup>7)</sup>		
Dimensional drawing → <a href="#">F-116</a>										

<sup>1)</sup> FC fiber optic fiber cutter included in scope of delivery.










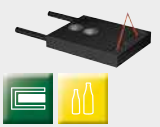








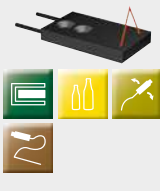








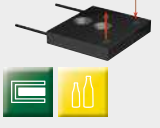

















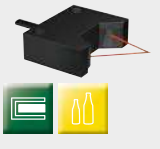








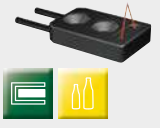








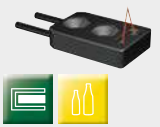







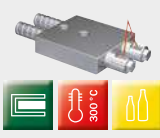








<sup>2)</sup> Minimum detectable object was determined at optimal measuring distance and optimal setting.

<sup>3)</sup> Operating mode: 16 µs. <sup>4)</sup> Operating mode: 70 µs. <sup>5)</sup> Operating mode: 250 µs. <sup>6)</sup> Operating mode: 2 ms. <sup>7)</sup> Operating mode: 8 ms.

<sup>8)</sup> Operating mode: 250 µs (potentiometer). <sup>9)</sup> Operating mode: 50 µs (teach-in). <sup>10)</sup> Operating mode: 250 µs (teach-in).

Fiber optic cables with lengths different to the products shown here are available on request.

**B**

Figure	Length	Min. object diameter <sup>2)</sup>	Bend radius, fiber-optic cable	Ambient temperature, operation	Sensing range with GLL170 in mm		Sensing range with WLL180T in mm		Type	Part no.
	3 m <sup>1)</sup>	-	4 mm	0 °C ... +70 °C	 14 <sup>8)</sup>	 18 <sup>3)</sup>	LL3-DC04	5326018		
					 16 <sup>9)</sup>	 31 <sup>4)</sup>				
					 19 <sup>10)</sup>	 34 <sup>5)</sup>				
					-	 38 <sup>6)</sup>				
					-	 38 <sup>7)</sup>				
Dimensional drawing → F-116										
	3 m	25 mm	25 mm	0 °C ... +70 °C	 25 <sup>8)</sup>	 18 <sup>3)</sup>	LL3-DC05	5326016		
					 30 <sup>9)</sup>	 29 <sup>4)</sup>				
					 33 <sup>10)</sup>	 35 <sup>5)</sup>				
					-	 40 <sup>6)</sup>				
					-	 43 <sup>7)</sup>				
Dimensional drawing → F-116										
	2 m <sup>1)</sup>	-	4 mm	0 °C ... +70 °C	 9 <sup>8)</sup>	 15 <sup>3)</sup>	LL3-DC06	5326017		
					 11 <sup>9)</sup>	 22 <sup>4)</sup>				
					 12 <sup>10)</sup>	 23 <sup>5)</sup>				
					-	 25 <sup>6)</sup>				
					-	 25 <sup>7)</sup>				
Dimensional drawing → F-116										
		0.06 mm	10 mm	-40 °C ... +60 °C	 9 <sup>8)</sup>	 8 <sup>3)</sup>	LL3-DC07	5326019		
					 6.5 <sup>9)</sup>	 12 <sup>4)</sup>				
					 8 <sup>10)</sup>	 14 <sup>5)</sup>				
					-	 16 <sup>6)</sup>				
					-	 18 <sup>7)</sup>				
Dimensional drawing → F-116										
	1 m <sup>1)</sup>	0.3 mm	1 mm	-20 °C ... +60 °C	 6 <sup>8)</sup>	 2 <sup>3)</sup>	LL3-DC08	5326029		
					 7 <sup>9)</sup>	 4 <sup>4)</sup>				
					 8 <sup>10)</sup>	 6 <sup>5)</sup>				
					-	 9 <sup>6)</sup>				
					-	 10 <sup>7)</sup>				
Dimensional drawing → F-117										
				-40 °C ... +70 °C	 9 <sup>8)</sup>	 8 <sup>3)</sup>	LL3-DC09	5326028		
					 114 <sup>9)</sup>	 10 <sup>4)</sup>				
					 19 <sup>10)</sup>	 11 <sup>5)</sup>				
					-	 13 <sup>6)</sup>				
					-	 17 <sup>7)</sup>				
Dimensional drawing → F-117										
	2 m <sup>1)</sup>	0.02 mm	10 mm	-40 °C ... +50 °C	 8 <sup>7)</sup>	 6 <sup>2)</sup>	LL3-DC38	5322472		
					 9 <sup>8)</sup>	 6 <sup>3)</sup>				
					 13 <sup>9)</sup>	 6 <sup>4)</sup>				
					-	 10 <sup>5)</sup>				
					-	 15 <sup>6)</sup>				
Dimensional drawing → F-117										
				-40 °C ... +50 °C	 4 <sup>8)</sup>	-	LL3-DC39	5322513		
					 6 <sup>9)</sup>	 4 <sup>4)</sup>				
					 7 <sup>10)</sup>	 4 <sup>5)</sup>				
					-	 4 <sup>6)</sup>				
					-	 4 <sup>7)</sup>				
Dimensional drawing → F-117										
	2 m	0.02 mm	25 mm	-30 °C ... +300 °C	 14 <sup>8)</sup>	 5 <sup>3)</sup>	LL3-DH06	5326026		
					 20 <sup>9)</sup>	 10 <sup>4)</sup>				
					 30 <sup>10)</sup>	 19 <sup>5)</sup>				
					-	 37 <sup>6)</sup>				
					-	 43 <sup>7)</sup>				
Dimensional drawing → F-120										

<sup>1)</sup> FC fiber optic fiber cutter included in scope of delivery.

<sup>2)</sup> Minimum detectable object was determined at optimal measuring distance and optimal setting.

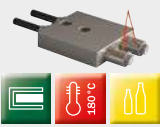








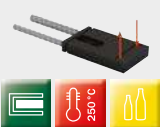








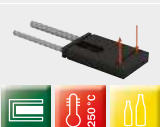

















<sup>3)</sup> Operating mode: 16 µs. <sup>4)</sup> Operating mode: 70 µs. <sup>5)</sup> Operating mode: 250 µs. <sup>6)</sup> Operating mode: 2 ms. <sup>7)</sup> Operating mode: 8 ms.

<sup>8)</sup> Operating mode: 250 µs (potentiometer). <sup>9)</sup> Operating mode: 50 µs (teach-in). <sup>10)</sup> Operating mode: 250 µs (teach-in).

Fiber optic cables with lengths different to the products shown here are available on request.



B

Figure	Length	Min. object diameter <sup>2)</sup>	Bend radius, fiber-optic cable	Ambient temperature, operation	Sensing range with GLL170 in mm		Sensing range with WLL180T in mm		Type	Part no.
	2 m <sup>1)</sup>	0.02 mm	25 mm	-60 °C ... +180 °C	 7 <sup>8)</sup>	 5 <sup>3)</sup>	LL3-DH08	5326025		
					 6 <sup>9)</sup>	 11 <sup>4)</sup>				
					 12 <sup>10)</sup>	 22 <sup>5)</sup>				
					-	 30 <sup>6)</sup>				
					-	 38 <sup>7)</sup>				
Dimensional drawing → F-120										
	3 m	0.02 mm	25 mm	-20 °C ... +250 °C	 16.8 <sup>8)</sup>	 11 <sup>3)</sup>	LL3-DH10	5326023		
					 9 <sup>9)</sup>	 18 <sup>4)</sup>				
					 13 <sup>10)</sup>	 21 <sup>5)</sup>				
					-	 24 <sup>6)</sup>				
					-	 26 <sup>7)</sup>				
Dimensional drawing → F-120										
	3 m	0.02 mm	25 mm	-20 °C ... +250 °C	 26 <sup>8)</sup>	 19 <sup>3)</sup>	LL3-DH11	5326024		
					 14.5 <sup>9)</sup>	 29 <sup>4)</sup>				
					 19 <sup>10)</sup>	 34 <sup>5)</sup>				
					-	 39 <sup>6)</sup>				
					-	 42 <sup>7)</sup>				
Dimensional drawing → F-120										
	2 m <sup>1)</sup>	0.03 mm	1 mm	-20 °C ... +70 °C	 370 <sup>8)</sup>	 110 <sup>3)</sup>	LL3-DR09	5325528		
					 230 <sup>9)</sup>	 345 <sup>4)</sup>				
					 400 <sup>10)</sup>	 560 <sup>5)</sup>				
					-	 1,100 <sup>6)</sup>				
					-	 1,190 <sup>7)</sup>				
Dimensional drawing → F-124										

<sup>1)</sup> FC fiber optic fiber cutter included in scope of delivery.

<sup>2)</sup> Minimum detectable object was determined at optimal measuring distance and optimal setting.

<sup>3)</sup> Operating mode: 16 µs. <sup>4)</sup> Operating mode: 70 µs. <sup>5)</sup> Operating mode: 250 µs. <sup>6)</sup> Operating mode: 2 ms. <sup>7)</sup> Operating mode: 8 ms.

<sup>8)</sup> Operating mode: 250 µs (potentiometer). <sup>9)</sup> Operating mode: 50 µs (teach-in). <sup>10)</sup> Operating mode: 250 µs (teach-in).

Fiber optic cables with lengths different to the products shown here are available on request.



LCDS/transparent objects/semiconductors, through-beam system

**B**

Figure	Length	Min. object diameter <sup>2)</sup>	Bend radius, fiber-optic cable	Ambient temperature, operation	Sensing range with GLL170 in mm		Sensing range with WLL180T in mm		Type	Part no.
	25 mm	0.06 mm	25 mm	-40 °C ... +70 °C	3,500 <sup>8)</sup>	880 <sup>3)</sup>	2,350 <sup>9)</sup>	2,300 <sup>4)</sup>	LL3-TG01	5325940
					2,400 <sup>10)</sup>	3,500 <sup>5)</sup>				
					-	4,000 <sup>6)</sup>				
					-	4,000 <sup>7)</sup>				
					Dimensional drawing → F-137					
	1 mm	0.06 mm	1 mm	-40 °C ... +55 °C	1,730 <sup>8)</sup>	580 <sup>3)</sup>	1,650 <sup>9)</sup>	1,670 <sup>4)</sup>	LL3-TG02	5325943
					2,060 <sup>10)</sup>	2,400 <sup>5)</sup>				
					-	4,000 <sup>6)</sup>				
					-	4,000 <sup>7)</sup>				
					Dimensional drawing → F-137					
	25 mm	0.06 mm	25 mm	-40 °C ... +60 °C	1,600 <sup>8)</sup>	570 <sup>3)</sup>	1,950 <sup>9)</sup>	1,980 <sup>4)</sup>	LL3-TG03	5325942
					2,060 <sup>10)</sup>	2,400 <sup>5)</sup>				
					-	4,000 <sup>6)</sup>				
					-	4,000 <sup>7)</sup>				
					Dimensional drawing → F-137					
	10 mm	0.02 mm	10 mm	-40 °C ... +60 °C	400 <sup>8)</sup>	100 <sup>3)</sup>	280 <sup>9)</sup>	290 <sup>4)</sup>	LL3-TG04	5324499
					430 <sup>10)</sup>	500 <sup>5)</sup>				
					-	1,000 <sup>6)</sup>				
					-	1,100 <sup>7)</sup>				
					Dimensional drawing → F-137					
	1 mm	0.06 mm	1 mm	-40 °C ... +60 °C	560 <sup>8)</sup>	160 <sup>3)</sup>	470 <sup>9)</sup>	480 <sup>4)</sup>	LL3-TR08	5325984
					690 <sup>10)</sup>	800 <sup>5)</sup>				
					-	1,600 <sup>6)</sup>				
					-	1,700 <sup>7)</sup>				
					Dimensional drawing → F-142					
	1 mm	0.04 mm	1 mm	-40 °C ... +60 °C	1,490 <sup>8)</sup>	360 <sup>3)</sup>	1,220 <sup>9)</sup>	1,200 <sup>4)</sup>	LL3-TR09	5325985
					1,970 <sup>10)</sup>	2,200 <sup>5)</sup>				
					-	4,000 <sup>6)</sup>				
					-	4,000 <sup>7)</sup>				
					Dimensional drawing → F-142					
	25 mm	-	25 mm	-40 °C ... +70 °C	1,470 <sup>8)</sup>	390 <sup>3)</sup>	1,130 <sup>9)</sup>	1,300 <sup>4)</sup>	LL3-TS22	5325944
					1,980 <sup>10)</sup>	2,600 <sup>5)</sup>				
					-	4,000 <sup>6)</sup>				
					-	4,000 <sup>7)</sup>				
					Dimensional drawing → F-144					
	10 mm	-	10 mm	-40 °C ... +105 °C	1,190 <sup>8)</sup>	220 <sup>3)</sup>	1,040 <sup>9)</sup>	760 <sup>4)</sup>	LL3-TS22M	5325968
					1,740 <sup>10)</sup>	1,500 <sup>5)</sup>				
					-	2,900 <sup>6)</sup>				
					-	4,000 <sup>7)</sup>				
					Dimensional drawing → F-144					

<sup>1)</sup> FC fiber optic fiber cutter included in scope of delivery.

<sup>2)</sup> Minimum detectable object was determined at optimal measuring distance and optimal setting.

<sup>3)</sup> Operating mode: 16 µs. <sup>4)</sup> Operating mode: 70 µs. <sup>5)</sup> Operating mode: 250 µs. <sup>6)</sup> Operating mode: 2 ms. <sup>7)</sup> Operating mode: 8 ms.

<sup>8)</sup> Operating mode: 250 µs (potentiometer). <sup>9)</sup> Operating mode: 50 µs (teach-in). <sup>10)</sup> Operating mode: 250 µs (teach-in).

Fiber optic cables with lengths different to the products shown here are available on request.

B



Detecting parts in the grabber

### Robotics

These special fibers are designed for use in robotic applications involving repeated bending. Even after more than 800,000 bending cycles, transmission is reduced by less than 10%.



### Robotics, proximity system

Figure	Length	Min. object diameter <sup>2)</sup>	Bend radius, fiber-optic cable	Ambient temperature, operation	Sensing range with GLL170 in mm		Sensing range with WLL180T in mm		Type	Part no.
	3 m <sup>1)</sup>	-	4 mm	0 °C ... +70 °C		14 <sup>8)</sup>		18 <sup>3)</sup>	LL3-DC04	5326018
						16 <sup>9)</sup>		31 <sup>4)</sup>		
						19 <sup>10)</sup>		34 <sup>5)</sup>		
					-	-		38 <sup>6)</sup>		
									Dimensional drawing → F-116	
	2 m <sup>1)</sup>	-	4 mm	0 °C ... +70 °C		9 <sup>8)</sup>		15 <sup>3)</sup>	LL3-DC06	5326017
						11 <sup>9)</sup>		22 <sup>4)</sup>		
						12 <sup>10)</sup>		23 <sup>5)</sup>		
					-	-		25 <sup>6)</sup>		
									Dimensional drawing → F-116	

<sup>1)</sup> FC fiber optic fiber cutter included in scope of delivery.
































































<sup>2)</sup> Minimum detectable object was determined at optimal measuring distance and optimal setting.

<sup>3)</sup> Operating mode: 16 µs. <sup>4)</sup> Operating mode: 70 µs. <sup>5)</sup> Operating mode: 250 µs. <sup>6)</sup> Operating mode: 2 ms. <sup>7)</sup> Operating mode: 8 ms.

<sup>8)</sup> Operating mode: 250 µs (potentiometer). <sup>9)</sup> Operating mode: 50 µs (teach-in). <sup>10)</sup> Operating mode: 250 µs (teach-in).

Fiber optic cables with lengths different to the products shown here are available on request.

**B**

Figure	Length	Min. object diameter <sup>2)</sup>	Bend radius, fiber-optic cable	Ambient temperature, operation	Sensing range with GLL170 in mm		Sensing range with WLL180T in mm		Type	Part no.
	2 m <sup>1)</sup>	0.015 mm	4 mm	-40 °C ... +70 °C	 140 <sup>8)</sup>	 90 <sup>3)</sup>	LL3-DR01	5308078		
					 140 <sup>9)</sup>	 280 <sup>4)</sup>				
					 260 <sup>10)</sup>	 450 <sup>5)</sup>				
					-	 880 <sup>6)</sup>				
					-	 1,350 <sup>7)</sup>				
Dimensional drawing → F-123										
	1 m <sup>1)</sup>	0.015 mm	4 mm	-40 °C ... +70 °C	 30 <sup>8)</sup>	 18 <sup>3)</sup>	LL3-DR02	5308079		
					 20 <sup>9)</sup>	 50 <sup>4)</sup>				
					 40 <sup>10)</sup>	 90 <sup>5)</sup>				
					-	 200 <sup>6)</sup>				
					-	 370 <sup>7)</sup>				
Dimensional drawing → F-123										
	2 m <sup>1)</sup>	0.015 mm	4 mm	-40 °C ... +70 °C	 40 <sup>8)</sup>	 30 <sup>3)</sup>	LL3-DR03	5308080		
					 40 <sup>9)</sup>	 85 <sup>4)</sup>				
					 80 <sup>10)</sup>	 140 <sup>5)</sup>				
					-	 300 <sup>6)</sup>				
					-	 600 <sup>7)</sup>				
Dimensional drawing → F-123										
	1 m	0.015 mm	4 mm	-40 °C ... +70 °C	 20 <sup>8)</sup>	 20 <sup>3)</sup>	LL3-DR04	5308081		
					 30 <sup>9)</sup>	 70 <sup>4)</sup>				
					 60 <sup>10)</sup>	 110 <sup>5)</sup>				
					-	 220 <sup>6)</sup>				
					-	 360 <sup>7)</sup>				
Dimensional drawing → F-123										
	500 mm	0.015 mm	4 mm	-40 °C ... +70 °C	 10 <sup>8)</sup>	 10 <sup>3)</sup>	LL3-DR05	5308087		
					 10 <sup>9)</sup>	 30 <sup>4)</sup>				
					 30 <sup>10)</sup>	 60 <sup>5)</sup>				
					-	 140 <sup>6)</sup>				
					-	 225 <sup>7)</sup>				
Dimensional drawing → F-123										
	2 m <sup>1)</sup>	0.015 mm	4 mm	-40 °C ... +70 °C	 40 <sup>8)</sup>	 18 <sup>3)</sup>	LL3-DR06	5308082		
					 30 <sup>9)</sup>	 60 <sup>4)</sup>				
					 60 <sup>10)</sup>	 100 <sup>5)</sup>				
					-	 220 <sup>6)</sup>				
					-	 360 <sup>7)</sup>				
Dimensional drawing → F-123										
	2 m <sup>1)</sup>	0.02 mm	4 mm	-40 °C ... +70 °C	 30 <sup>8)</sup>	 8 <sup>3)</sup>	LL3-DR08	5326037		
					 10 <sup>9)</sup>	 25 <sup>4)</sup>				
					 30 <sup>10)</sup>	 46 <sup>5)</sup>				
					-	 90 <sup>6)</sup>				
					-	 98 <sup>7)</sup>				
Dimensional drawing → F-124										

<sup>1)</sup> FC fiber optic fiber cutter included in scope of delivery.



















<sup>2)</sup> Minimum detectable object was determined at optimal measuring distance and optimal setting.

<sup>3)</sup> Operating mode: 16 µs. <sup>4)</sup> Operating mode: 70 µs. <sup>5)</sup> Operating mode: 250 µs. <sup>6)</sup> Operating mode: 2 ms. <sup>7)</sup> Operating mode: 8 ms.

<sup>8)</sup> Operating mode: 250 µs (potentiometer). <sup>9)</sup> Operating mode: 50 µs (teach-in). <sup>10)</sup> Operating mode: 250 µs (teach-in).

Fiber optic cables with lengths different to the products shown here are available on request.

B

Figure	Length	Min. object diameter <sup>2)</sup>	Bend radius, fiber-optic cable	Ambient temperature, operation	Sensing range with GLL170 in mm		Sensing range with WLL180T in mm		Type	Part no.
	500 mm <sup>1)</sup>	0.015 mm	4 mm	-40 °C ... +70 °C		10 <sup>8)</sup>		10 <sup>3)</sup>	LL3-DT02	5308085
						10 <sup>9)</sup>		30 <sup>4)</sup>		
						30 <sup>10)</sup>		60 <sup>5)</sup>		
					-	-		140 <sup>6)</sup>		
					-	-		225 <sup>7)</sup>		
Dimensional drawing → F-125										
	500 mm	0.015 mm	4 mm	-40 °C ... +70 °C		20 <sup>8)</sup>		13 <sup>3)</sup>	LL3-DT04	5308086
						20 <sup>9)</sup>		45 <sup>4)</sup>		
						40 <sup>10)</sup>		80 <sup>5)</sup>		
					-	-		140 <sup>6)</sup>		
					-	-		280 <sup>7)</sup>		
Dimensional drawing → F-125										

<sup>1)</sup> FC fiber optic fiber cutter included in scope of delivery.

<sup>2)</sup> Minimum detectable object was determined at optimal measuring distance and optimal setting.

<sup>3)</sup> Operating mode: 16 µs. <sup>4)</sup> Operating mode: 70 µs. <sup>5)</sup> Operating mode: 250 µs. <sup>6)</sup> Operating mode: 2 ms. <sup>7)</sup> Operating mode: 8 ms.

<sup>8)</sup> Operating mode: 250 µs (potentiometer). <sup>9)</sup> Operating mode: 50 µs (teach-in). <sup>10)</sup> Operating mode: 250 µs (teach-in).

Fiber optic cables with lengths different to the products shown here are available on request.



Robotics, through-beam system

Figure	Length	Min. object diameter <sup>2)</sup>	Bend radius, fiber-optic cable	Ambient temperature, operation	Sensing range with GLL170 in mm		Sensing range with WLL180T in mm		Type	Part no.
  Suitable for tip adapters	2 m <sup>1)</sup>	0.3 mm	4 mm	-40 °C ... +70 °C	 470 <sup>8)</sup>	 200 <sup>3)</sup>	LL3-TR01	5308052		
					 380 <sup>9)</sup>	 600 <sup>4)</sup>				
					 680 <sup>10)</sup>	 1,000 <sup>5)</sup>				
					 -	 2,400 <sup>6)</sup>				
					 -	 4,000 <sup>7)</sup>				
 	5 m <sup>1)</sup>	0.3 mm	4 mm	-40 °C ... +70 °C	 250 <sup>8)</sup>	 160 <sup>3)</sup>	LL3-TR01-05	5322198		
					 400 <sup>9)</sup>	 450 <sup>4)</sup>				
					 600 <sup>10)</sup>	 800 <sup>5)</sup>				
					 -	 1,900 <sup>6)</sup>				
					 -	 2,800 <sup>7)</sup>				
 	2 m <sup>1)</sup>	0.1 mm	4 mm	-40 °C ... +70 °C	 130 <sup>8)</sup>	 60 <sup>3)</sup>	LL3-TR02	5308053		
					 100 <sup>9)</sup>	 175 <sup>4)</sup>				
					 180 <sup>10)</sup>	 330 <sup>5)</sup>				
					 -	 750 <sup>6)</sup>				
					 -	 1,100 <sup>7)</sup>				
 	1 m <sup>1)</sup>	0.1 mm	4 mm	-40 °C ... +70 °C	 140 <sup>8)</sup>	 60 <sup>3)</sup>	LL3-TR03	5308054		
					 150 <sup>9)</sup>	 175 <sup>4)</sup>				
					 240 <sup>10)</sup>	 330 <sup>5)</sup>				
					 -	 750 <sup>6)</sup>				
					 -	 1,100 <sup>7)</sup>				
 	2 m <sup>1)</sup>	0.1 mm	4 mm	-40 °C ... +70 °C	 140 <sup>8)</sup>	 60 <sup>3)</sup>	LL3-TR03-2	5308055		
					 150 <sup>9)</sup>	 175 <sup>4)</sup>				
					 240 <sup>10)</sup>	 330 <sup>5)</sup>				
					 -	 750 <sup>6)</sup>				
					 -	 1,100 <sup>7)</sup>				
 	500 mm	0.02 mm	4 mm	-40 °C ... +60 °C	 40 <sup>8)</sup>	 5 <sup>3)</sup>	LL3-TR04	5325918		
					 20 <sup>9)</sup>	 17 <sup>4)</sup>				
					 50 <sup>10)</sup>	 28 <sup>5)</sup>				
					 -	 56 <sup>6)</sup>				
					 -	 60 <sup>7)</sup>				
 	2 m <sup>1)</sup>	0.03 mm	4 mm	-40 °C ... +60 °C	 1,830 <sup>8)</sup>	 360 <sup>3)</sup>	LL3-TR05	5325808		
					 1,280 <sup>9)</sup>	 1,300 <sup>4)</sup>				
					 2,000 <sup>10)</sup>	 2,300 <sup>5)</sup>				
					 -	 4,000 <sup>6)</sup>				
					 -	 4,000 <sup>7)</sup>				
 	2 m <sup>1)</sup>	0.03 mm	4 mm	-40 °C ... +60 °C	 1,830 <sup>8)</sup>	 560 <sup>3)</sup>	LL3-TR06	5325912		
					 1,600 <sup>9)</sup>	 1,600 <sup>4)</sup>				
					 1,950 <sup>10)</sup>	 2,200 <sup>5)</sup>				
					 -	 4,000 <sup>6)</sup>				
					 -	 4,000 <sup>7)</sup>				

<sup>1)</sup> FC fiber optic fiber cutter included in scope of delivery.

<sup>2)</sup> Minimum detectable object was determined at optimal measuring distance and optimal setting.

<sup>3)</sup> Operating mode: 16 µs. <sup>4)</sup> Operating mode: 70 µs. <sup>5)</sup> Operating mode: 250 µs. <sup>6)</sup> Operating mode: 2 ms. <sup>7)</sup> Operating mode: 8 ms.

<sup>8)</sup> Operating mode: 250 µs (potentiometer). <sup>9)</sup> Operating mode: 50 µs (teach-in). <sup>10)</sup> Operating mode: 250 µs (teach-in).

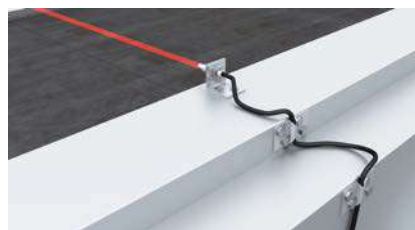
Fiber optic cables with lengths different to the products shown here are available on request.

**B**

B



Highly-flexible fibers



Standard fibers.

### Highly-flexible fibers

The highly-flexible fibers can be bent to a minimum bend radius of 1 mm. This means that you do not need to worry about damaging the fibers during installation.



### Highly-flexible fibers, proximity system

Figure	Length	Min. object diameter <sup>2)</sup>	Bend radius, fiber-optic cable	Ambient temperature, operation	Sensing range with GLL170 in mm		Sensing range with WLL180T in mm		Type	Part no.
	3 m <sup>1)</sup>	-	4 mm	0 °C ... +70 °C		14 <sup>8)</sup>		18 <sup>3)</sup>	LL3-DC04	5326018
						16 <sup>9)</sup>		31 <sup>4)</sup>		
						19 <sup>10)</sup>		34 <sup>5)</sup>		
						-		38 <sup>6)</sup>		
Dimensional drawing → <a href="#">F-116</a>										
	2 m <sup>1)</sup>	-	4 mm	0 °C ... +70 °C		9 <sup>8)</sup>		15 <sup>3)</sup>	LL3-DC06	5326017
						11 <sup>9)</sup>		22 <sup>4)</sup>		
						12 <sup>10)</sup>		23 <sup>5)</sup>		
						-		25 <sup>6)</sup>		
Dimensional drawing → <a href="#">F-116</a>										

<sup>1)</sup> FC fiber optic fiber cutter included in scope of delivery.

<sup>2)</sup> Minimum detectable object was determined at optimal measuring distance and optimal setting.




































































































<sup>3)</sup> Operating mode: 16 µs. <sup>4)</sup> Operating mode: 70 µs. <sup>5)</sup> Operating mode: 250 µs. <sup>6)</sup> Operating mode: 2 ms. <sup>7)</sup> Operating mode: 8 ms.

<sup>8)</sup> Operating mode: 250 µs (potentiometer). <sup>9)</sup> Operating mode: 50 µs (teach-in). <sup>10)</sup> Operating mode: 250 µs (teach-in).

<sup>11)</sup> Retro-reflective fiber with polarizing filter and reflector.

Fiber optic cables with lengths different to the products shown here are available on request.

**B**

Figure	Length	Min. object diameter <sup>2)</sup>	Bend radius, fiber-optic cable	Ambient temperature, operation	Sensing range with GLL170 in mm		Sensing range with WLL180T in mm		Type	Part no.
	2 m <sup>1)</sup>	0.01 mm	1 mm	-40 °C ... +60 °C	 32 <sup>8)</sup>	 12 <sup>3)</sup>	LL3-DC47	5324268		
					 30 <sup>9)</sup>	 25 <sup>4)</sup>				
					 52 <sup>10)</sup>	 37 <sup>5)</sup>				
					 -	 75 <sup>6)</sup>				
					 -	 90 <sup>7)</sup>				
Dimensional drawing → F-117										
	1 m <sup>1)</sup>	0.16 mm	1 mm	-40 °C ... +60 °C	 40 <sup>8)</sup>	 11 <sup>3)</sup>	LL3-DE01	5325285		
					 20 <sup>9)</sup>	 38 <sup>4)</sup>				
					 50 <sup>10)</sup>	 78 <sup>5)</sup>				
					 -	 150 <sup>6)</sup>				
					 -	 160 <sup>7)</sup>				
Dimensional drawing → F-117										
	1 m <sup>1)</sup>	0.01 mm	1 mm	-40 °C ... +60 °C	 40 <sup>8)</sup>	 13 <sup>3)</sup>	LL3-DE02	5324497		
					 30 <sup>9)</sup>	 48 <sup>4)</sup>				
					 60 <sup>10)</sup>	 86 <sup>5)</sup>				
					 -	 170 <sup>6)</sup>				
					 -	 180 <sup>7)</sup>				
Dimensional drawing → F-118										
	1 m <sup>1)</sup>	0.03 mm	1 mm	-40 °C ... +60 °C	 150 <sup>8)</sup>	 45 <sup>3)</sup>	LL3-DE03	5325986		
					 90 <sup>9)</sup>	 130 <sup>4)</sup>				
					 180 <sup>10)</sup>	 250 <sup>5)</sup>				
					 -	 510 <sup>6)</sup>				
					 -	 550 <sup>7)</sup>				
Dimensional drawing → F-118										
	1 m <sup>1)</sup>	0.03 mm	1 mm	-40 °C ... +60 °C	 150 <sup>8)</sup>	 50 <sup>3)</sup>	LL3-DE04	5325987		
					 90 <sup>9)</sup>	 130 <sup>4)</sup>				
					 180 <sup>10)</sup>	 250 <sup>5)</sup>				
					 -	 500 <sup>6)</sup>				
					 -	 540 <sup>7)</sup>				
Dimensional drawing → F-118										
	2 m <sup>1)</sup>	0.015 mm	2 mm	-40 °C ... +70 °C	 120 <sup>8)</sup>	 65 <sup>3)</sup>	LL3-DK4Z	5313026		
					 160 <sup>9)</sup>	 200 <sup>4)</sup>				
					 290 <sup>10)</sup>	 350 <sup>5)</sup>				
					 -	 650 <sup>6)</sup>				
					 -	 1,000 <sup>7)</sup>				
Dimensional drawing → F-122										
	2 m <sup>1)</sup>	0.015 mm	2 mm	-40 °C ... +70 °C	 120 <sup>8)</sup>	 90 <sup>3)</sup>	LL3-DK63Z	5313027		
					 160 <sup>9)</sup>	 300 <sup>4)</sup>				
					 290 <sup>10)</sup>	 500 <sup>5)</sup>				
					 -	 900 <sup>6)</sup>				
					 -	 1,400 <sup>7)</sup>				
Dimensional drawing → F-122										
	2 m <sup>1)</sup>	0.015 mm	2 mm	-40 °C ... +70 °C	 120 <sup>8)</sup>	 90 <sup>3)</sup>	LL3-DK66	5313024		
					 160 <sup>9)</sup>	 300 <sup>4)</sup>				
					 290 <sup>10)</sup>	 500 <sup>5)</sup>				
					 -	 900 <sup>6)</sup>				
					 -	 1,400 <sup>7)</sup>				
Dimensional drawing → F-122										
	2 m <sup>1)</sup>	0.015 mm	2 mm	-40 °C ... +70 °C	 120 <sup>8)</sup>	 90 <sup>3)</sup>	LL3-DK67	5313025		
					 160 <sup>9)</sup>	 300 <sup>4)</sup>				
					 290 <sup>10)</sup>	 500 <sup>5)</sup>				
					 -	 900 <sup>6)</sup>				
					 -	 1,400 <sup>7)</sup>				
Dimensional drawing → F-122										

<sup>1)</sup> FC fiber optic fiber cutter included in scope of delivery.

<sup>2)</sup> Minimum detectable object was determined at optimal measuring distance and optimal setting.

<sup>3)</sup> Operating mode: 16 µs. <sup>4)</sup> Operating mode: 70 µs. <sup>5)</sup> Operating mode: 250 µs. <sup>6)</sup> Operating mode: 2 ms. <sup>7)</sup> Operating mode: 8 ms.





















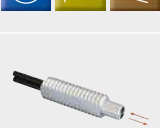

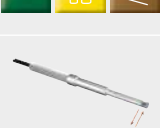
<sup>8)</sup> Operating mode: 250 µs (potentiometer). <sup>9)</sup> Operating mode: 50 µs (teach-in). <sup>10)</sup> Operating mode: 250 µs (teach-in).

<sup>11)</sup> Retro-reflective fiber with polarizing filter and reflector.

Fiber optic cables with lengths different to the products shown here are available on request.



B

Figure	Length	Min. object diameter <sup>2)</sup>	Bend radius, fiber-optic cable	Ambient temperature, operation	Sensing range with GLL170 in mm		Sensing range with WLL180T in mm		Type	Part no.
	2 m <sup>1)</sup>	0.015 mm	4 mm	-40 °C ... +70 °C	 140 <sup>8)</sup>	 90 <sup>3)</sup>	LL3-DR01	5308078	Dimensional drawing → F-123	
					 140 <sup>9)</sup>	 280 <sup>4)</sup>				
					 260 <sup>10)</sup>	 450 <sup>5)</sup>				
					-	 880 <sup>6)</sup>				
					-	 1,350 <sup>7)</sup>				
	1 m <sup>1)</sup>	0.015 mm	4 mm	-40 °C ... +70 °C	 30 <sup>8)</sup>	 18 <sup>3)</sup>	LL3-DR02	5308079	Dimensional drawing → F-123	
					 20 <sup>9)</sup>	 50 <sup>4)</sup>				
					 40 <sup>10)</sup>	 90 <sup>5)</sup>				
					-	 200 <sup>6)</sup>				
					-	 370 <sup>7)</sup>				
	2 m <sup>1)</sup>	0.015 mm	4 mm	-40 °C ... +70 °C	40 <sup>8)</sup>	30 <sup>3)</sup>	LL3-DR03	5308080	Dimensional drawing → F-123	
					40 <sup>9)</sup>	85 <sup>4)</sup>				
					80 <sup>10)</sup>	140 <sup>5)</sup>				
					-	300 <sup>6)</sup>				
					-	600 <sup>7)</sup>				
	1 m	0.015 mm	4 mm	-40 °C ... +70 °C	20 <sup>8)</sup>	20 <sup>3)</sup>	LL3-DR04	5308081	Dimensional drawing → F-123	
					30 <sup>9)</sup>	70 <sup>4)</sup>				
					60 <sup>10)</sup>	110 <sup>5)</sup>				
					-	220 <sup>6)</sup>				
					-	360 <sup>7)</sup>				
	2 m <sup>1)</sup>	0.015 mm	4 mm	-40 °C ... +70 °C	40 <sup>8)</sup>	18 <sup>3)</sup>	LL3-DR06	5308082	Dimensional drawing → F-123	
					30 <sup>9)</sup>	60 <sup>4)</sup>				
					60 <sup>10)</sup>	100 <sup>5)</sup>				
					-	220 <sup>6)</sup>				
					-	360 <sup>7)</sup>				
	2 m <sup>1)</sup>	0.03 mm	1 mm	-20 °C ... +70 °C	370 <sup>8)</sup>	110 <sup>3)</sup>	LL3-DR09	5325528	Dimensional drawing → F-124	
					230 <sup>9)</sup>	345 <sup>4)</sup>				
					400 <sup>10)</sup>	560 <sup>5)</sup>				
					-	1,100 <sup>6)</sup>				
					-	1,190 <sup>7)</sup>				
	500 mm <sup>1)</sup>	0.015 mm	4 mm	-40 °C ... +70 °C	10 <sup>8)</sup>	10 <sup>3)</sup>	LL3-DT02	5308085	Dimensional drawing → F-125	
					10 <sup>9)</sup>	30 <sup>4)</sup>				
					30 <sup>10)</sup>	60 <sup>5)</sup>				
					-	140 <sup>6)</sup>				
					-	225 <sup>7)</sup>				

<sup>1)</sup> FC fiber optic fiber cutter included in scope of delivery.




























<sup>2)</sup> Minimum detectable object was determined at optimal measuring distance and optimal setting.

<sup>3)</sup> Operating mode: 16 µs. <sup>4)</sup> Operating mode: 70 µs. <sup>5)</sup> Operating mode: 250 µs. <sup>6)</sup> Operating mode: 2 ms. <sup>7)</sup> Operating mode: 8 ms.

<sup>8)</sup> Operating mode: 250 µs (potentiometer). <sup>9)</sup> Operating mode: 50 µs (teach-in). <sup>10)</sup> Operating mode: 250 µs (teach-in).

<sup>11)</sup> Retro-reflective fiber with polarizing filter and reflector.

Fiber optic cables with lengths different to the products shown here are available on request.

Figure	Length	Min. object diameter <sup>2)</sup>	Bend radius, fiber-optic cable	Ambient temperature, operation	Sensing range with GLL170 in mm		Sensing range with WLL180T in mm		Type	Part no.
	500 mm	0.015 mm	4 mm	-40 °C ... +70 °C	 20 <sup>8)</sup>	 13 <sup>3)</sup>	LL3-DT04	5308086		
					 20 <sup>9)</sup>	 45 <sup>4)</sup>				
					 40 <sup>10)</sup>	 80 <sup>5)</sup>				
					-	 140 <sup>6)</sup>				
					-	 280 <sup>7)</sup>				
Dimensional drawing → F-125										
	2 m <sup>1)</sup>	0.015 mm	2 mm	-40 °C ... +70 °C	 60 <sup>8)</sup>	 20 <sup>3)</sup>	LL3-DV07	5322551		
					 60 <sup>9)</sup>	 110 <sup>4)</sup>				
					 100 <sup>10)</sup>	 180 <sup>5)</sup>				
					-	 400 <sup>6)</sup>				
					-	 650 <sup>7)</sup>				
Dimensional drawing → F-126										
	0.3 mm	0.3 mm	1 mm	-25 °C ... +55 °C	 410 <sup>8)</sup>	 290 <sup>3)</sup>	LL3-RR01 <sup>11)</sup>	5326008		
					 380 <sup>9)</sup>	 580 <sup>4)</sup>				
					 520 <sup>10)</sup>	 720 <sup>5)</sup>				
					-	 1,450 <sup>6)</sup>				
					-	 1,550 <sup>7)</sup>				
Dimensional drawing → F-132										

<sup>1)</sup> FC fiber optic fiber cutter included in scope of delivery.

<sup>2)</sup> Minimum detectable object was determined at optimal measuring distance and optimal setting.

<sup>3)</sup> Operating mode: 16 µs. <sup>4)</sup> Operating mode: 70 µs. <sup>5)</sup> Operating mode: 250 µs. <sup>6)</sup> Operating mode: 2 ms. <sup>7)</sup> Operating mode: 8 ms.

<sup>8)</sup> Operating mode: 250 µs (potentiometer). <sup>9)</sup> Operating mode: 50 µs (teach-in). <sup>10)</sup> Operating mode: 250 µs (teach-in).

<sup>11)</sup> Retro-reflective fiber with polarizing filter and reflector.

Fiber optic cables with lengths different to the products shown here are available on request.

**B**



Highly-flexible fibers, through-beam system

B

Figure	Length	Min. object diameter <sup>2)</sup>	Bend radius, fiber-optic cable	Ambient temperature, operation	Sensing range with GLL170 in mm		Sensing range with WLL180T in mm		Type	Part no.
	2 m <sup>1)</sup>	0.01 mm	1 mm	-40 °C ... +60 °C		117 <sup>8)</sup>		35 <sup>3)</sup>	LL3-DC57	5324269
						178 <sup>9)</sup>		45 <sup>4)</sup>		
						300 <sup>10)</sup>		55 <sup>5)</sup>		
						-		250 <sup>6)</sup>		
						-		330 <sup>7)</sup>		
Dimensional drawing → F-133										
	1 m <sup>1)</sup>	0.08 mm	1 mm	-40 °C ... +60 °C		480 <sup>8)</sup>		120 <sup>3)</sup>	LL3-TE01	5325807
						370 <sup>9)</sup>		350 <sup>4)</sup>		
						630 <sup>10)</sup>		620 <sup>5)</sup>		
						-		1,250 <sup>6)</sup>		
						-		1,330 <sup>7)</sup>		
Dimensional drawing → F-136										
	1 m <sup>1)</sup>	0.08 mm	1 mm	-40 °C ... +60 °C		180 <sup>8)</sup>		40 <sup>3)</sup>	LL3-TE02	5325910
						140 <sup>9)</sup>		140 <sup>4)</sup>		
						190 <sup>10)</sup>		220 <sup>5)</sup>		
						-		450 <sup>6)</sup>		
						-		480 <sup>7)</sup>		
Dimensional drawing → F-136										
	1 m <sup>1)</sup>	0.08 mm	1 mm	-40 °C ... +60 °C		760 <sup>8)</sup>		190 <sup>3)</sup>	LL3-TE03	5325908
						600 <sup>9)</sup>		580 <sup>4)</sup>		
						1,010 <sup>10)</sup>		980 <sup>5)</sup>		
						-		1,970 <sup>6)</sup>		
						-		2,100 <sup>7)</sup>		
Dimensional drawing → F-136										
	1 m <sup>1)</sup>	0.03 mm	1 mm	-40 °C ... +60 °C		500 <sup>8)</sup>		150 <sup>3)</sup>	LL3-TE04	5325911
						430 <sup>9)</sup>		440 <sup>4)</sup>		
						600 <sup>10)</sup>		700 <sup>5)</sup>		
						-		1,400 <sup>6)</sup>		
						-		1,490 <sup>7)</sup>		
Dimensional drawing → F-137										
	2 m <sup>1)</sup>	0.03 mm	4 mm	-40 °C ... +60 °C		570 <sup>8)</sup>		150 <sup>3)</sup>	LL3-TE05	5325914
						450 <sup>9)</sup>		460 <sup>4)</sup>		
						720 <sup>10)</sup>		840 <sup>5)</sup>		
						-		1,680 <sup>6)</sup>		
						-		1,780 <sup>7)</sup>		
Dimensional drawing → F-137										
	1 m <sup>1)</sup>	0.06 mm	1 mm	-40 °C ... +55 °C		1,730 <sup>8)</sup>		580 <sup>3)</sup>	LL3-TG02	5325943
						1,650 <sup>9)</sup>		1,670 <sup>4)</sup>		
						2,060 <sup>10)</sup>		2,400 <sup>5)</sup>		
						-		4,000 <sup>6)</sup>		
						-		4,000 <sup>7)</sup>		
Dimensional drawing → F-137										
	1 m <sup>1)</sup>	0.02 mm	10 mm	-40 °C ... +60 °C		400 <sup>8)</sup>		100 <sup>3)</sup>	LL3-TG04	5324499
						280 <sup>9)</sup>		290 <sup>4)</sup>		
						430 <sup>10)</sup>		500 <sup>5)</sup>		
						-		1,000 <sup>6)</sup>		
						-		1,100 <sup>7)</sup>		
Dimensional drawing → F-137										










<sup>1)</sup> FC fiber optic fiber cutter included in scope of delivery.

<sup>2)</sup> Minimum detectable object was determined at optimal measuring distance and optimal setting.

<sup>3)</sup> Operating mode: 16 µs. <sup>4)</sup> Operating mode: 70 µs. <sup>5)</sup> Operating mode: 250 µs. <sup>6)</sup> Operating mode: 2 ms. <sup>7)</sup> Operating mode: 8 ms.

<sup>8)</sup> Operating mode: 250 µs (potentiometer). <sup>9)</sup> Operating mode: 50 µs (teach-in). <sup>10)</sup> Operating mode: 250 µs (teach-in).

Fiber optic cables with lengths different to the products shown here are available on request.

Figure	Length	Min. object diameter <sup>2)</sup>	Bend radius, fiber-optic cable	Ambient temperature, operation	Sensing range with GLL170 in mm		Sensing range with WLL180T in mm		Type	Part no.
	2 m <sup>1)</sup>	0.02 mm	1 mm	-40 °C ... +60 °C	40 <sup>8)</sup>	13 <sup>3)</sup>	LL3-TG05	5325921		
					30 <sup>9)</sup>	50 <sup>4)</sup>				
					60 <sup>10)</sup>	85 <sup>5)</sup>				
					-	170 <sup>6)</sup>				
					-	180 <sup>7)</sup>				
Dimensional drawing → F-137										
	2 m <sup>1)</sup>	0.2 mm	2 mm	-40 °C ... +70 °C	540 <sup>8)</sup>	220 <sup>3)</sup>	LL3-TK05	5313034		
					450 <sup>9)</sup>	650 <sup>4)</sup>				
					760 <sup>10)</sup>	1,200 <sup>5)</sup>				
					-	2,750 <sup>6)</sup>				
					-	4,000 <sup>7)</sup>				
Dimensional drawing → F-140										
 Suitable for tip adapters	2 m <sup>1)</sup>	0.2 mm	2 mm	-40 °C ... +70 °C	420 <sup>8)</sup>	220 <sup>3)</sup>	LL3-TK77	5313035		
					450 <sup>9)</sup>	650 <sup>4)</sup>				
					760 <sup>10)</sup>	1,200 <sup>5)</sup>				
					-	2,750 <sup>6)</sup>				
					-	4,000 <sup>7)</sup>				
Dimensional drawing → F-140										
	500 mm	0.02 mm	5 mm	-40 °C ... +70 °C	8 <sup>8)</sup>	2 <sup>3)</sup>	LL3-TP01	5325925		
					8 <sup>9)</sup>	8 <sup>4)</sup>				
					12 <sup>10)</sup>	14 <sup>5)</sup>				
					-	28 <sup>6)</sup>				
					-	30 <sup>7)</sup>				
Dimensional drawing → F-141										
 Suitable for tip adapters	2 m <sup>1)</sup>	0.3 mm	4 mm	-40 °C ... +70 °C	470 <sup>8)</sup>	200 <sup>3)</sup>	LL3-TR01	5308052		
					380 <sup>9)</sup>	600 <sup>4)</sup>				
					680 <sup>10)</sup>	1,000 <sup>5)</sup>				
					-	2,400 <sup>6)</sup>				
					-	4,000 <sup>7)</sup>				
Dimensional drawing → F-141										
	5 m <sup>1)</sup>	0.3 mm	4 mm	-40 °C ... +70 °C	250 <sup>8)</sup>	160 <sup>3)</sup>	LL3-TR01-05	5322198		
					400 <sup>9)</sup>	450 <sup>4)</sup>				
					600 <sup>10)</sup>	800 <sup>5)</sup>				
					-	1,900 <sup>6)</sup>				
					-	2,800 <sup>7)</sup>				
Dimensional drawing → F-141										
	2 m <sup>1)</sup>	0.1 mm	4 mm	-40 °C ... +70 °C	130 <sup>8)</sup>	60 <sup>3)</sup>	LL3-TR02	5308053		
					100 <sup>9)</sup>	175 <sup>4)</sup>				
					180 <sup>10)</sup>	330 <sup>5)</sup>				
					-	750 <sup>6)</sup>				
					-	1,100 <sup>7)</sup>				
Dimensional drawing → F-141										
	1 m <sup>1)</sup>	0.1 mm	4 mm	-40 °C ... +70 °C	140 <sup>8)</sup>	60 <sup>3)</sup>	LL3-TR03	5308054		
					150 <sup>9)</sup>	175 <sup>4)</sup>				
					240 <sup>10)</sup>	330 <sup>5)</sup>				
					-	750 <sup>6)</sup>				
					-	1,100 <sup>7)</sup>				
Dimensional drawing → F-141										
	2 m <sup>1)</sup>	0.1 mm	4 mm	-40 °C ... +70 °C	140 <sup>8)</sup>	60 <sup>3)</sup>	LL3-TR03-2	5308055		
					150 <sup>9)</sup>	175 <sup>4)</sup>				
					240 <sup>10)</sup>	330 <sup>5)</sup>				
					-	750 <sup>6)</sup>				
					-	1,100 <sup>7)</sup>				
Dimensional drawing → F-141										

<sup>1)</sup> FC fiber optic fiber cutter included in scope of delivery.

<sup>2)</sup> Minimum detectable object was determined at optimal measuring distance and optimal setting.

<sup>3)</sup> Operating mode: 16 µs. <sup>4)</sup> Operating mode: 70 µs. <sup>5)</sup> Operating mode: 250 µs. <sup>6)</sup> Operating mode: 2 ms. <sup>7)</sup> Operating mode: 8 ms.

<sup>8)</sup> Operating mode: 250 µs (potentiometer). <sup>9)</sup> Operating mode: 50 µs (teach-in). <sup>10)</sup> Operating mode: 250 µs (teach-in).

Fiber optic cables with lengths different to the products shown here are available on request.

**B**

B

Figure	Length	Min. object diameter <sup>2)</sup>	Bend radius, fiber-optic cable	Ambient temperature, operation	Sensing range with GLL170 in mm		Sensing range with WLL180T in mm		Type	Part no.
	500 mm	0.02 mm	4 mm	-40 °C ... +60 °C	40 <sup>8)</sup>	5 <sup>3)</sup>	LL3-TR04	5325918		
					20 <sup>9)</sup>	17 <sup>4)</sup>				
					50 <sup>10)</sup>	28 <sup>5)</sup>				
					-	56 <sup>6)</sup>				
					-	60 <sup>7)</sup>				
Dimensional drawing → F-141										
	2 m <sup>1)</sup>	0.03 mm	4 mm	-40 °C ... +60 °C	1,830 <sup>8)</sup>	360 <sup>3)</sup>	LL3-TR05	5325808		
					1,280 <sup>9)</sup>	1,300 <sup>4)</sup>				
					2,000 <sup>10)</sup>	2,300 <sup>5)</sup>				
					-	4,000 <sup>6)</sup>				
					-	4,000 <sup>7)</sup>				
Dimensional drawing → F-141										
	2 m <sup>1)</sup>	0.03 mm	4 mm	-40 °C ... +60 °C	1,830 <sup>8)</sup>	560 <sup>3)</sup>	LL3-TR06	5325912		
					1,600 <sup>9)</sup>	1,600 <sup>4)</sup>				
					1,950 <sup>10)</sup>	2,200 <sup>5)</sup>				
					-	4,000 <sup>6)</sup>				
					-	4,000 <sup>7)</sup>				
Dimensional drawing → F-142										
	2 m <sup>1)</sup>	0.06 mm	1 mm	-40 °C ... +60 °C	560 <sup>8)</sup>	160 <sup>3)</sup>	LL3-TR08	5325984		
					470 <sup>9)</sup>	480 <sup>4)</sup>				
					690 <sup>10)</sup>	800 <sup>5)</sup>				
					-	1,600 <sup>6)</sup>				
					-	1,700 <sup>7)</sup>				
Dimensional drawing → F-142										
	2 m <sup>1)</sup>	0.04 mm	1 mm	-40 °C ... +60 °C	1,490 <sup>8)</sup>	360 <sup>3)</sup>	LL3-TR09	5325985		
					1,220 <sup>9)</sup>	1,200 <sup>4)</sup>				
					1,970 <sup>10)</sup>	2,200 <sup>5)</sup>				
					-	4,000 <sup>6)</sup>				
					-	4,000 <sup>7)</sup>				
Dimensional drawing → F-142										
	2 m <sup>1)</sup>	0.02 mm	1 mm	-40 °C ... +60 °C	1,070 <sup>8)</sup>	380 <sup>3)</sup>	LL3-TR10	5325920		
					1,200 <sup>9)</sup>	1,220 <sup>4)</sup>				
					1,750 <sup>10)</sup>	2,000 <sup>5)</sup>				
					-	4,000 <sup>6)</sup>				
					-	4,000 <sup>7)</sup>				
Dimensional drawing → F-142										
	2 m <sup>1)</sup>	0.08 mm	1 mm	-40 °C ... +60 °C	1,570 <sup>8)</sup>	590 <sup>3)</sup>	LL3-TR11	5325906		
					1,490 <sup>9)</sup>	1,500 <sup>4)</sup>				
					1,950 <sup>10)</sup>	2,200 <sup>5)</sup>				
					-	4,000 <sup>6)</sup>				
					-	4,000 <sup>7)</sup>				
Dimensional drawing → F-142										
	2 m <sup>1)</sup>	0.05 mm	1 mm	-40 °C ... +60 °C	2,130 <sup>8)</sup>	600 <sup>3)</sup>	LL3-TR12	5325907		
					1,410 <sup>9)</sup>	1,400 <sup>4)</sup>				
					2,000 <sup>10)</sup>	2,300 <sup>5)</sup>				
					-	4,000 <sup>6)</sup>				
					-	4,000 <sup>7)</sup>				
Dimensional drawing → F-142										
	2 m <sup>1)</sup>	0.04 mm	1 mm	-40 °C ... +60 °C	920 <sup>8)</sup>	250 <sup>3)</sup>	LL3-TR13	5325909		
					720 <sup>9)</sup>	730 <sup>4)</sup>				
					1,210 <sup>10)</sup>	1,280 <sup>5)</sup>				
					-	2,560 <sup>6)</sup>				
					-	2,730 <sup>7)</sup>				
Dimensional drawing → F-143										

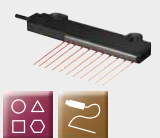



































<sup>1)</sup> FC fiber optic fiber cutter included in scope of delivery.

<sup>2)</sup> Minimum detectable object was determined at optimal measuring distance and optimal setting.

<sup>3)</sup> Operating mode: 16 µs. <sup>4)</sup> Operating mode: 70 µs. <sup>5)</sup> Operating mode: 250 µs. <sup>6)</sup> Operating mode: 2 ms. <sup>7)</sup> Operating mode: 8 ms.

<sup>8)</sup> Operating mode: 250 µs (potentiometer). <sup>9)</sup> Operating mode: 50 µs (teach-in). <sup>10)</sup> Operating mode: 250 µs (teach-in).

Fiber optic cables with lengths different to the products shown here are available on request.

Figure	Length	Min. object diameter <sup>2)</sup>	Bend radius, fiber-optic cable	Ambient temperature, operation	Sensing range with GLL170 in mm		Sensing range with WLL180T in mm		Type	Part no.	
	2 m <sup>1)</sup>	0.4 mm	2 mm	-40 °C ... +60 °C	 350 <sup>8)</sup>	 3,000 <sup>3)</sup>	LL3-TS40	5323971			
					 350 <sup>9)</sup>	 4,000 <sup>4)</sup>					
					 350 <sup>10)</sup>	 4,000 <sup>5)</sup>					
					-	 4,000 <sup>6)</sup>					
					-	 4,000 <sup>7)</sup>					
				-40 °C ... +70 °C	 460 <sup>8)</sup>	 340 <sup>3)</sup>	LL3-TV07	5322548			
					 840 <sup>9)</sup>	 1,000 <sup>4)</sup>					
					 1,290 <sup>10)</sup>	 1,800 <sup>5)</sup>					
					-	 4,000 <sup>6)</sup>					
					-	 4,000 <sup>7)</sup>					
	-40 °C ... +70 °C	 200 <sup>8)</sup>	 340 <sup>3)</sup>	LL3-TV77	5326557						
		 640 <sup>9)</sup>	 1,000 <sup>4)</sup>								
		 1,068 <sup>10)</sup>	 1,800 <sup>5)</sup>								
		-	 4,000 <sup>6)</sup>								
		-	 4,000 <sup>7)</sup>								
	0.25 mm	1 mm	-40 °C ... +55 °C	 2,000 <sup>8)</sup>	 1,300 <sup>3)</sup>	LL3-TZ09	5326598				
				 2,000 <sup>9)</sup>	 2,500 <sup>4)</sup>						
				 2,500 <sup>10)</sup>	 3,000 <sup>5)</sup>						
				-	 3,500 <sup>6)</sup>						
				-	 4,000 <sup>7)</sup>						
Dimensional drawing → F-144											
Dimensional drawing → F-145											
Dimensional drawing → F-146											

**B**

<sup>1)</sup> FC fiber optic fiber cutter included in scope of delivery.

<sup>2)</sup> Minimum detectable object was determined at optimal measuring distance and optimal setting.

<sup>3)</sup> Operating mode: 16 µs. <sup>4)</sup> Operating mode: 70 µs. <sup>5)</sup> Operating mode: 250 µs. <sup>6)</sup> Operating mode: 2 ms. <sup>7)</sup> Operating mode: 8 ms.

<sup>8)</sup> Operating mode: 250 µs (potentiometer). <sup>9)</sup> Operating mode: 50 µs (teach-in). <sup>10)</sup> Operating mode: 250 µs (teach-in).

Fiber optic cables with lengths different to the products shown here are available on request.



Tip adapters, proximity system

Tip adapters are available for a variety of fibers. They focus the light beam at a defined distance. For proximity style fibers, a very small light spot is created for detecting fine and small objects. The LL3-DA07 tip adapter also deflects the light by 90°.

Figure	Temperature	Light spot size			Focal length [mm]	Type	Part no.
		LL3-DK21	LL3-DT01	LL3-DM02			
	-40 °C ... +70 °C	Ø 0.2 mm	Ø 0.4 mm	-	6	LL3-DA01	5308127
	-40 °C ... +70 °C	Ø 1.2 mm	Ø 1.4 mm	-	15	LL3-DA02	5308130
	-20 °C ... +60 °C	Ø 0. mm	Ø 0.4 mm	-	7	LL3-DA03	5326465
	-40 °C ... +70 °C	Ø 0.3 mm	Ø 0.5 mm	-	7.5	LL3-DA04	5326466
	-40 °C ... +70 °C	-	-	Ø 0.5 mm	6	LL3-DA05	5326467
	-40 °C ... +70 °C	-	-	Ø 0.7 mm ... 0.85 mm	~ 20	LL3-DA06	5326468
	-40 °C ... +70 °C	-	-	Ø 0.5 mm ... 0.8 mm	~ 14	LL3-DA07	5326469

Dimensional drawings → [Page F-149](#)

**C**





Adapter lenses






C



Tip adapters, through-beam system

Tip adapters are available for a variety of fibers. They focus the light beam. The sensing range of through-beam fibers can be considerably increased by using tip adapters. Focusing the light beam also minimizes the risk of the light being directed past any highly reflective surfaces on the object. The LL3-TA02 and LL3-TA05 models enable an additional 90° deflection.

Sensing ranges with GLL170 amplifier




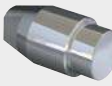
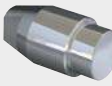






Figure	Temperature	LL type/sensing range (mm)							
		LL3-TB01	LL3-TB01-10	LL3-TB01-30	LL3-TB02	LL3-TB06	LL3-TH01		
	-40 °C ... +100 °C	> 3,500 <sup>1)</sup>	2,500 <sup>1)</sup>	1,200 <sup>1)</sup>	3,100 <sup>1)</sup>	3000 <sup>1)</sup>	-	-	
		> 3,500 <sup>2)</sup>	3,800 <sup>2)</sup>	1,800 <sup>2)</sup>	> 3,500 <sup>2)</sup>	> 3,500 <sup>2)</sup>			
	-40 °C ... +70 °C	> 3,500 <sup>3)</sup>	2,700 <sup>3)</sup>	1,300 <sup>3)</sup>	3,000 <sup>3)</sup>	2,950 <sup>3)</sup>	-	-	
		> 3,500 <sup>1)</sup>	2,500 <sup>1)</sup>	1,200 <sup>1)</sup>	3,100 <sup>1)</sup>	3000 <sup>1)</sup>			
	-40 °C ... +350 °C	> 3,500 <sup>2)</sup>	3,800 <sup>2)</sup>	1,800 <sup>2)</sup>	> 3,500 <sup>2)</sup>	> 3,500 <sup>2)</sup>	-	-	
		> 3,500 <sup>3)</sup>	2,700 <sup>3)</sup>	1,300 <sup>3)</sup>	3,000 <sup>3)</sup>	2,950 <sup>3)</sup>			
	-60 °C ... +350 °C	> 3,500 <sup>1)</sup>	10,300 <sup>1)</sup>	5,000 <sup>1)</sup>	3,500 <sup>1)</sup>	3,500 <sup>1)</sup>	-	-	
		> 3,500 <sup>2)</sup>	15,000 <sup>2)</sup>	7,400 <sup>2)</sup>	3,500 <sup>2)</sup>	3,500 <sup>2)</sup>			
	-60 °C ... +300 °C	> 3,500 <sup>3)</sup>	9,400 <sup>3)</sup>	4,500 <sup>3)</sup>	3,500 <sup>3)</sup>	3,500 <sup>3)</sup>	-	-	
		1,000 <sup>1)</sup>	620 <sup>1)</sup>	300 <sup>1)</sup>	770 <sup>1)</sup>	740 <sup>1)</sup>			
		1,500 <sup>2)</sup>	940 <sup>2)</sup>	450 <sup>2)</sup>	1,050 <sup>2)</sup>	1,050 <sup>2)</sup>			
		930 <sup>3)</sup>	570 <sup>3)</sup>	270 <sup>3)</sup>	650 <sup>3)</sup>	640 <sup>3)</sup>			

<sup>1)</sup> Operating mode: 250 μs (potentiometer). <sup>2)</sup> Operating mode: 50 μs (teach-in). <sup>3)</sup> Operating mode: 250 μs (teach-in). Mounting material included.

Dimensional drawings → Page F-148

		LL model name/sensing range (mm)										Type	Part no.		
		LL3-TH08		LL3-TH10		LL3-TH11		LL3-TJ01		LL3-TK77		LL3-TR01			
		-	-	-	-	-	-	> 1,500 <sup>1)</sup> > 1,500 <sup>2)</sup> > 1,500 <sup>3)</sup>	2,100 <sup>1)</sup> 3,500 <sup>2)</sup> 2,450 <sup>3)</sup>	2,300 <sup>1)</sup> 3,200 <sup>2)</sup> 2,050 <sup>3)</sup>	LL3-TA01	5308128			
		-	-	-	-	-	-	> 1,500 <sup>1)</sup> > 1,500 <sup>2)</sup> > 1,500 <sup>3)</sup>	2,100 <sup>1)</sup> 3,500 <sup>2)</sup> 2,450 <sup>3)</sup>	2,300 <sup>1)</sup> 3,200 <sup>2)</sup> 2,050 <sup>3)</sup>	LL3-TA01S	5326461			
		-	-	-	-	-	-	700 <sup>1)</sup> 980 <sup>2)</sup> 560 <sup>3)</sup>	550 <sup>1)</sup> 1,050 <sup>2)</sup> 560 <sup>3)</sup>	600 <sup>1)</sup> 950 <sup>2)</sup> 480 <sup>3)</sup>	LL3-TA02	5308129			
		2,500 <sup>1)</sup> 3,100 <sup>2)</sup> 2,500 <sup>3)</sup>	870 <sup>1)</sup> 1,200 <sup>2)</sup> 960 <sup>3)</sup>	> 1,500 <sup>1)</sup> > 1,500 <sup>2)</sup> > 1,500 <sup>3)</sup>	> 1,500 <sup>1)</sup> > 1,500 <sup>2)</sup> > 1,500 <sup>3)</sup>	> 1,500 <sup>1)</sup> > 1,500 <sup>2)</sup> > 1,500 <sup>3)</sup>	> 1,500 <sup>1)</sup> > 1,500 <sup>2)</sup> > 1,500 <sup>3)</sup>	1,800 <sup>1)</sup> 3,200 <sup>2)</sup> 2,200 <sup>3)</sup>	2,000 <sup>1)</sup> 2,800 <sup>2)</sup> 1,900 <sup>3)</sup>	LL3-TA03	5326462				
		3,500 <sup>1)</sup> 3,500 <sup>2)</sup> 3,500 <sup>3)</sup>	> 1,500 <sup>1)</sup> > 1,500 <sup>2)</sup> > 1,500 <sup>3)</sup>	> 1,500 <sup>1)</sup> > 1,500 <sup>2)</sup> > 1,500 <sup>3)</sup>	> 1,500 <sup>1)</sup> > 1,500 <sup>2)</sup> > 1,500 <sup>3)</sup>	> 1,500 <sup>1)</sup> > 1,500 <sup>2)</sup> > 1,500 <sup>3)</sup>	> 1,500 <sup>1)</sup> > 1,500 <sup>2)</sup> > 1,500 <sup>3)</sup>	3,500 <sup>1)</sup> 3,500 <sup>2)</sup> 3,500 <sup>3)</sup>	3,500 <sup>1)</sup> 3,500 <sup>2)</sup> 3,500 <sup>3)</sup>	LL3-TA04	5326463				
		700 <sup>1)</sup> 870 <sup>2)</sup> 590 <sup>3)</sup>	240 <sup>1)</sup> 330 <sup>2)</sup> 220 <sup>3)</sup>	500 <sup>1)</sup> 800 <sup>2)</sup> 500 <sup>3)</sup>	680 <sup>1)</sup> 840 <sup>2)</sup> 530 <sup>3)</sup>	680 <sup>1)</sup> 840 <sup>2)</sup> 530 <sup>3)</sup>	680 <sup>1)</sup> 840 <sup>2)</sup> 530 <sup>3)</sup>	520 <sup>1)</sup> 900 <sup>2)</sup> 520 <sup>3)</sup>	580 <sup>1)</sup> 800 <sup>2)</sup> 440 <sup>3)</sup>	LL3-TA05	5326464				

Sensing ranges with WLL180T amplifier

Figure	Temperature	LL model name/sensing range (mm)							
		LL3-TB01	LL3-TB01-10	LL3-TB01-30	LL3-TB02	LL3-TB06	LL3-TH01		
	-40 °C ... +100 °C	800 <sup>1)</sup>	720 <sup>1)</sup>	570 <sup>1)</sup>	1,800 <sup>1)</sup>	1,500 <sup>1)</sup>	500 <sup>1)</sup>		
		2,500 <sup>2)</sup>	2,250 <sup>2)</sup>	1,800 <sup>2)</sup>	4,000 <sup>2)</sup>	4,000 <sup>2)</sup>	1,400 <sup>2)</sup>		
	-40 °C ... +70 °C	200 <sup>1)</sup>	180 <sup>1)</sup>	150 <sup>1)</sup>	300 <sup>1)</sup>				
		650 <sup>2)</sup>	585 <sup>2)</sup>	460 <sup>2)</sup>	1,000 <sup>2)</sup>	-	-	-	-
	-40 °C ... +350 °C	1,200 <sup>3)</sup>	1,080 <sup>3)</sup>	860 <sup>3)</sup>	1,800 <sup>3)</sup>				
		2,500 <sup>4)</sup>	2,250 <sup>4)</sup>	1,800 <sup>4)</sup>	3,500 <sup>4)</sup>				
	-60 °C ... +350 °C	3,600 <sup>5)</sup>	3,240 <sup>5)</sup>	2,600 <sup>5)</sup>	4,000 <sup>5)</sup>				
		360 <sup>1)</sup>	324 <sup>1)</sup>	260 <sup>1)</sup>	1,200 <sup>1)</sup>	1,200 <sup>1)</sup>	1,200 <sup>1)</sup>		
	-60 °C ... +350 °C	2,000 <sup>2)</sup>	1,800 <sup>2)</sup>	1,440 <sup>2)</sup>	4,000 <sup>2)</sup>	4,000 <sup>2)</sup>	4,000 <sup>2)</sup>	2,000 <sup>2)</sup>	
		4,000 <sup>3)</sup>	3,600 <sup>3)</sup>	2,880 <sup>3)</sup>	4,000 <sup>3)</sup>	4,000 <sup>3)</sup>	4,000 <sup>3)</sup>	4,000 <sup>3)</sup>	4,000 <sup>3)</sup>
	-60 °C ... +300 °C	4,000 <sup>4)</sup>	3,600 <sup>4)</sup>	2,880 <sup>4)</sup>	4,000 <sup>4)</sup>	4,000 <sup>4)</sup>	4,000 <sup>4)</sup>	4,000 <sup>4)</sup>	
		4,000 <sup>5)</sup>	3,600 <sup>5)</sup>	2,880 <sup>5)</sup>	4,000 <sup>5)</sup>	4,000 <sup>5)</sup>	4,000 <sup>5)</sup>	4,000 <sup>5)</sup>	4,000 <sup>5)</sup>
	-60 °C ... +300 °C	4,000 <sup>1)</sup>	3,600 <sup>1)</sup>	2,880 <sup>1)</sup>	4,000 <sup>1)</sup>	4,000 <sup>1)</sup>	4,000 <sup>1)</sup>	4,000 <sup>1)</sup>	
		4,000 <sup>2)</sup>	3,600 <sup>2)</sup>	2,880 <sup>2)</sup>	4,000 <sup>2)</sup>	4,000 <sup>2)</sup>	4,000 <sup>2)</sup>	4,000 <sup>2)</sup>	4,000 <sup>2)</sup>
	-60 °C ... +300 °C	4,000 <sup>3)</sup>	3,600 <sup>3)</sup>	2,880 <sup>3)</sup>	4,000 <sup>3)</sup>	4,000 <sup>3)</sup>	4,000 <sup>3)</sup>	4,000 <sup>3)</sup>	
		4,000 <sup>4)</sup>	3,600 <sup>4)</sup>	2,880 <sup>4)</sup>	4,000 <sup>4)</sup>	4,000 <sup>4)</sup>	4,000 <sup>4)</sup>	4,000 <sup>4)</sup>	4,000 <sup>4)</sup>
	-60 °C ... +300 °C	4,000 <sup>5)</sup>	3,600 <sup>5)</sup>	2,880 <sup>5)</sup>	4,000 <sup>5)</sup>	4,000 <sup>5)</sup>	4,000 <sup>5)</sup>	4,000 <sup>5)</sup>	
		250 <sup>1)</sup>	225 <sup>1)</sup>	180 <sup>1)</sup>	250 <sup>1)</sup>			160 <sup>1)</sup>	
	-60 °C ... +300 °C	800 <sup>2)</sup>	720 <sup>2)</sup>	570 <sup>2)</sup>	800 <sup>2)</sup>			450 <sup>2)</sup>	
		1,200 <sup>3)</sup>	1,080 <sup>3)</sup>	860 <sup>3)</sup>	1,200 <sup>3)</sup>			800 <sup>3)</sup>	
	-60 °C ... +300 °C	2,400 <sup>4)</sup>	2,160 <sup>4)</sup>	1,700 <sup>4)</sup>	2,400 <sup>4)</sup>			1,500 <sup>4)</sup>	
		4,000 <sup>5)</sup>	3,600 <sup>5)</sup>	2,880 <sup>5)</sup>	4,000 <sup>5)</sup>			4,000 <sup>5)</sup>	

<sup>1)</sup> Operating mode: 16 µs. <sup>2)</sup> Operating mode: 70 µs. <sup>3)</sup> Operating mode: 250 µs. <sup>4)</sup> Operating mode: 2 ms. <sup>5)</sup> Operating mode: 8 ms. Mounting material included.

Dimensional drawings → [Page F-148](#)

C

	LL model name/sensing range (mm)						Type	Part no.			
	LL3-TH08		LL3-TH10		LL3-TH11				LL3-TJ01		LL3-TK77
	-	-	-	-	-	-	750 <sup>1)</sup> 2,000 <sup>2)</sup> 2,000 <sup>3)</sup> 2,000 <sup>4)</sup> 2,000 <sup>5)</sup>	2,000 <sup>1)</sup> 4,000 <sup>2)</sup> 4,000 <sup>3)</sup> 4,000 <sup>4)</sup> 4,000 <sup>5)</sup>	1,800 <sup>1)</sup> 4,000 <sup>2)</sup> 4,000 <sup>3)</sup> 4,000 <sup>4)</sup> 4,000 <sup>5)</sup>	LL3-TA01	5308128
	-	-	-	-	-	-	650 <sup>1)</sup> 2,000 <sup>2)</sup> 2,000 <sup>3)</sup> 2,000 <sup>4)</sup> 2,000 <sup>5)</sup>	2,000 <sup>1)</sup> 4,000 <sup>2)</sup> 4,000 <sup>3)</sup> 4,000 <sup>4)</sup> 4,000 <sup>5)</sup>	1,800 <sup>1)</sup> 4,000 <sup>2)</sup> 4,000 <sup>3)</sup> 4,000 <sup>4)</sup> 4,000 <sup>5)</sup>	LL3-TA01S	5326461
	-	-	-	-	-	-	200 <sup>1)</sup> 600 <sup>2)</sup> 950 <sup>3)</sup> 1,900 <sup>4)</sup> 4,000 <sup>5)</sup>	300 <sup>1)</sup> 950 <sup>2)</sup> 1,800 <sup>3)</sup> 3,500 <sup>4)</sup> 4,000 <sup>5)</sup>	200 <sup>1)</sup> 900 <sup>2)</sup> 1,500 <sup>3)</sup> 3,300 <sup>4)</sup> 4,000 <sup>5)</sup>	LL3-TA02	5308129
	800 <sup>1)</sup> 2,000 <sup>2)</sup> 4,000 <sup>3)</sup> 4,000 <sup>4)</sup> 4,000 <sup>5)</sup>	750 <sup>1)</sup> 2,000 <sup>2)</sup> 2,000 <sup>3)</sup> 2,000 <sup>4)</sup> 2,000 <sup>5)</sup>	1,000 <sup>1)</sup> 2,000 <sup>2)</sup> 2,000 <sup>3)</sup> 2,000 <sup>4)</sup> 2,000 <sup>5)</sup>	600 <sup>1)</sup> 2,000 <sup>2)</sup> 2,000 <sup>3)</sup> 2,000 <sup>4)</sup> 2,000 <sup>5)</sup>	600 <sup>1)</sup> 2,000 <sup>2)</sup> 4,000 <sup>3)</sup> 4,000 <sup>4)</sup> 4,000 <sup>5)</sup>	800 <sup>1)</sup> 2,000 <sup>2)</sup> 4,000 <sup>3)</sup> 4,000 <sup>4)</sup> 4,000 <sup>5)</sup>	LL3-TA03	5326462			
	4,000 <sup>1)</sup> 4,000 <sup>2)</sup> 4,000 <sup>3)</sup> 4,000 <sup>4)</sup> 4,000 <sup>5)</sup>	2,000 <sup>1)</sup> 2,000 <sup>2)</sup> 2,000 <sup>3)</sup> 2,000 <sup>4)</sup> 2,000 <sup>5)</sup>	2,000 <sup>1)</sup> 2,000 <sup>2)</sup> 2,000 <sup>3)</sup> 2,000 <sup>4)</sup> 2,000 <sup>5)</sup>	2,000 <sup>1)</sup> 2,000 <sup>2)</sup> 2,000 <sup>3)</sup> 2,000 <sup>4)</sup> 2,000 <sup>5)</sup>	4,000 <sup>1)</sup> 4,000 <sup>2)</sup> 4,000 <sup>3)</sup> 4,000 <sup>4)</sup> 4,000 <sup>5)</sup>	4,000 <sup>1)</sup> 4,000 <sup>2)</sup> 4,000 <sup>3)</sup> 4,000 <sup>4)</sup> 4,000 <sup>5)</sup>	LL3-TA04	5326463			
	170 <sup>1)</sup> 550 <sup>2)</sup> 800 <sup>3)</sup> 1,600 <sup>4)</sup> 4,000 <sup>5)</sup>	100 <sup>1)</sup> 300 <sup>2)</sup> 600 <sup>3)</sup> 1,100 <sup>4)</sup> 2,000 <sup>5)</sup>	150 <sup>1)</sup> 400 <sup>2)</sup> 700 <sup>3)</sup> 1,400 <sup>4)</sup> 4,000 <sup>5)</sup>	200 <sup>1)</sup> 600 <sup>2)</sup> 950 <sup>3)</sup> 1,900 <sup>4)</sup> 4,000 <sup>5)</sup>	200 <sup>1)</sup> 600 <sup>2)</sup> 950 <sup>3)</sup> 1,900 <sup>4)</sup> 4,000 <sup>5)</sup>	160 <sup>1)</sup> 550 <sup>2)</sup> 850 <sup>3)</sup> 1,700 <sup>4)</sup> 4,000 <sup>5)</sup>	LL3-TA05	5326464			

C



## FIBER-OPTIC SENSORS

D



### Fit flexibly into the narrowest corners

When installation space is extremely limited or the objects to be detected are tiny, fiber-optic sensors are the ideal solution. If it is necessary for even higher requirements to be fulfilled, such as sensing range, temperature resistance, material durability or a flexible mounting process, the intelligent combination of sensors and fibers can provide the perfect solution. A wide range of fibers with application-specific optical heads ensure that every need is met.

### Your benefits

- Reliable and accurate detection of the smallest objects thanks to innovative, microcontroller-supported electronics
- EMC, high temperature tolerance and resistance to chemicals, as the evaluation electronics are mounted separately from the fiber-optic head
- Space-saving mounting even in confined spaces
- Multiple setting options provide solutions for practically any application
- Lightweight, suitable for use on a robot arm
- Universal application possibilities due to wide range of fibers



**Product family overview . . . . . D-88**



**GLL170 . . . . . D-92**  
Simple, flexible detection



**WLL180T . . . . . D-98**  
A global leader when it comes to sensing range and performance

**D**

## PRODUCT FAMILY OVERVIEW

	 <p style="text-align: center;"><b>GLL170</b></p>	 <p style="text-align: center;"><b>WLL180T</b></p>
	Simple, flexible detection	A global leader when it comes to sensing range and performance

Technical data overview		
Dimensions (W x H x D)	10 mm x 31.7 mm x 72.5 mm	10.5 mm x 34.6 mm x 71.9 mm
Type of light	Visible red light	Visible red light/infrared
Enclosure rating	IP 66	IP 50
Housing material	Plastic	Plastic
Setting	Potentiometer, teach-in button, cable	Menu-controlled, single teach-in button, cable
Response time	≤ 250 μs / ≤ 50 μs, selectable via menu	≤ 16 μs, ≤ 70 μs, ≤ 250 μs, ≤ 2,000 μs, ≤ 8,000 μs

At a glance		
Detailed information	<ul style="list-style-type: none"> <li>Intuitive operating concept</li> <li>Rapid response time of 50 μs</li> <li>Switching threshold adjustment via potentiometer, or teach-in via pushbutton or cable</li> <li>IP 66 enclosure rating for high degree of ruggedness</li> <li>PNP/NPN switchover (teach-in variant)</li> <li>4-digit digital display (teach-in variant)</li> <li>Variable fixing concept</li> <li>Various connection types available</li> </ul>	<ul style="list-style-type: none"> <li>Selectable response time up to 16 μs</li> <li>Sensing range up to 20 m (through-beam system); up to 1400 mm (proximity system)</li> <li>Bus-compatible with anti-interference</li> <li>2 x 4-digit digital display</li> <li>Adjustable hysteresis</li> <li>Rotatable display screen</li> <li>High-resolution signal processing</li> <li>Programmable time delays</li> </ul>
	→ D-92	→ D-98

D



Fast response time



The world's fastest fiber-optic sensor in its class with a 16  $\mu$ s response time for precise object positioning and detection in fast processes. It reliably detects up to 31,250 workpieces per second.

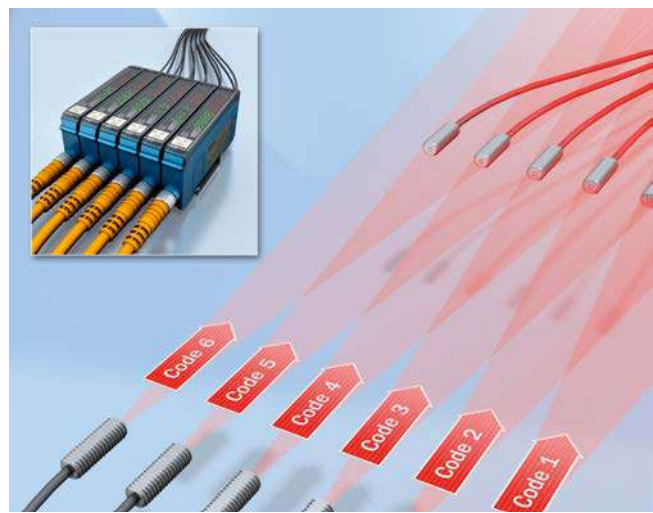
D

High sensing ranges and robustness against contamination



Even sensing ranges of up to 20 m can be achieved with the WLL180T and the corresponding fiber. The powerful light beam penetrates particles in the air. Workpieces are detected even under difficult conditions, such as dust, mist or spray.

Anti-interference



Synchronization of the transmission pulse pattern of up to 16 devices in bus mode. This prevents mutual interference when fiber-optic heads are mounted close to one another (anti-interference).



Efficient configuration



The copy function simplifies commissioning. When required, all settings can be copied to the other bus devices at the touch of a button.

All connected WLL180T sensors can be individually configured on the device or via the relevant teach-in cable. If all devices should be taught-in simultaneously, this can be done via bus coupling with a single teach-in cable.

In bus mode, the expansion units are supplied with voltage by the base unit which reduces the wiring work.

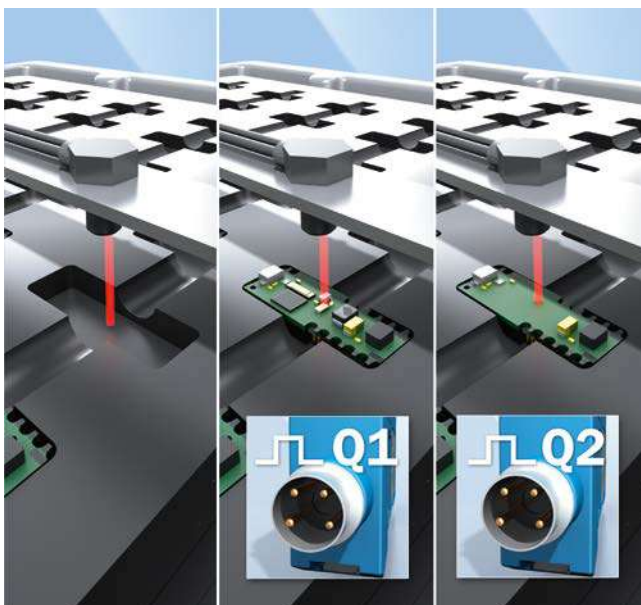
Variable display



Easy reading guaranteed: The 7-segment display can be turned upside down in difficult installation conditions.

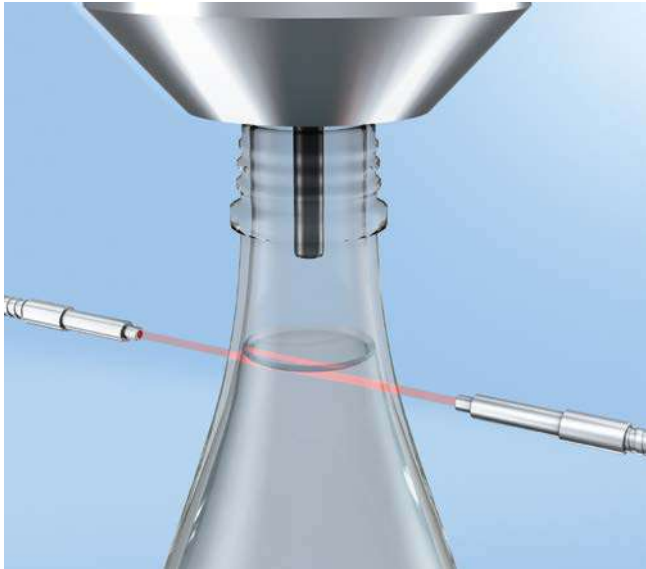
D

Variant with 2 switching outputs



The WLL180T variant with two switching outputs allows each of the two switching outputs to be independently configured. This eliminates the need for a separate trigger photoelectric sensor. Furthermore, it allows more information to be recorded that is available to the switching outputs. It is therefore possible to detect different object states.

Variant with infrared emitted light



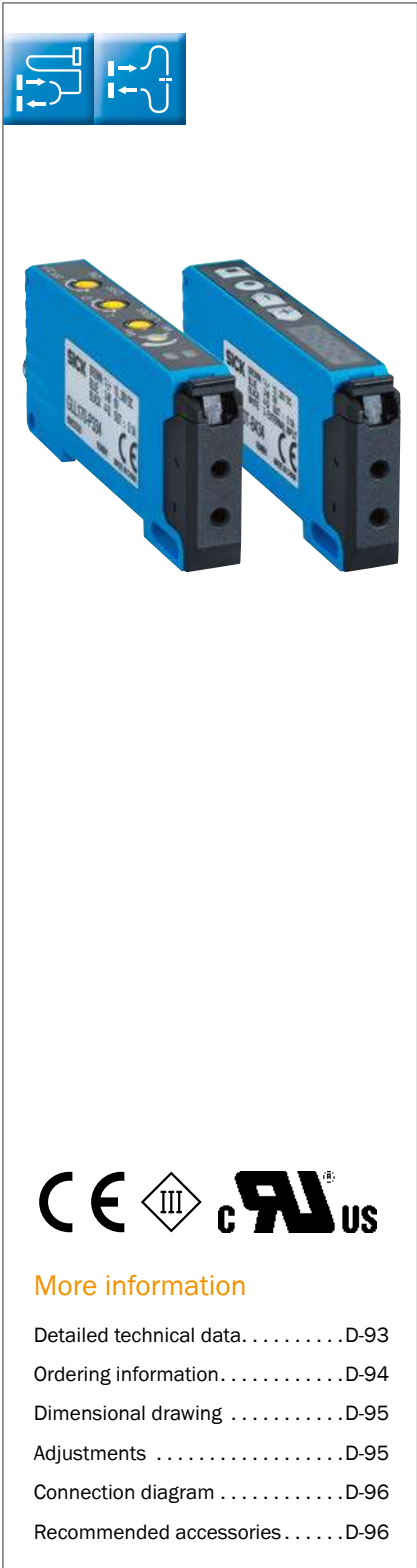
Fiber-optic amplifiers with optimized infrared emitted light (in conjunction with suitable glass fibers) enable a desired, specific liquid level to be indicated without the sensor having to come into contact with the liquid medium. Because water-based liquids almost completely absorb infrared emitted light, no undesirable optical effects (due to the liquid or transparent container) arise, which guarantees reliable detection.

General advantages



- The male/female connector design means installation on a mounting rail is extremely easy.
- ASC for maintenance-free operation: If, for example, the light intensity is reduced by dust, this is detected and the switching threshold compensates accordingly. The switching threshold is automatically recalibrated after the optics are cleaned.
- Adjustable hysteresis: The hysteresis can be adjusted from 1% to 40%. This allows flexible configuration for the detection of complex objects.
- Anti-blooming function to prevent overload

# SIMPLE, FLEXIBLE DETECTION



### Product description

The GLL170 fiber-optic sensor is the reliable solution for all detection tasks in combination with the fibers in the LL3 product family. With its simple operating concept, the sensor is ideal for applications in harsh environments as well as when rapid response times are crucial. Different variants are available to suit all requirements: The GLL170 variant with potentiometer enables quick and easy

commissioning thanks to its intuitive operation. The GLL170T variant with teach-in function features a display for direct sensor feedback and provides solutions for numerous applications with its range of adjustments. With a switching frequency of up to 10 kHz, this sensor can even handle rapid processes with ease.

### At a glance

- Intuitive operating concept
- Rapid response time of 50 μs
- Switching threshold adjustment via potentiometer, or teach-in via push-button or cable
- IP 66 enclosure rating for high degree of ruggedness
- PNP/NPN switchover (teach-in variant)
- 4-digit digital display (teach-in variant)
- Variable fixing concept
- Various connection types available

### Your benefits

- User-friendly handling enables fast commissioning
- Reliable detection even in rapid processes
- Easy to adjust with intuitive potentiometer or teach-in button
- Rugged sensor housing enables mounting outside the control cabinet
- Sensor parameters can be flexibly adapted to a diverse range of applications (teach-in variant)
- Easy monitoring of process parameters (teach-in variant)
- Quick and easy mounting on a mounting rail or using the fixing holes on the sensor
- Can be combined with fibers from the extensive SICK portfolio to form solutions for numerous applications



### More information

Detailed technical data.....D-93  
 Ordering information.....D-94  
 Dimensional drawing.....D-95  
 Adjustments.....D-95  
 Connection diagram.....D-96  
 Recommended accessories.....D-96

→ [www.sick.com/GLL170](http://www.sick.com/GLL170)

For more information, simply enter the link or scan the QR code to get direct access to technical data, CAD design models, operating instructions, software, application examples, and much more.



D

## Detailed technical data

## Features

	GLL170	GLL170T
<b>Sensor principle</b>	Fiber-optic sensor	
<b>Device type</b>	Standalone	
<b>Dimensions (W x H x D)</b>	10 mm x 31.7 mm x 72.5 mm	
<b>Housing design (light emission)</b>	Cuboid	
<b>Sensing range max.</b>	0 mm ... 190 mm, proximity system <sup>1) 2)</sup> 0 mm ... 800 mm, through-beam system <sup>3)</sup>	0 mm ... 400 mm, proximity system <sup>1) 2)</sup> 0 mm ... 1,320 mm, through-beam system <sup>3)</sup>
<b>Sensing range</b>	0 mm ... 160 mm, proximity system <sup>1) 2)</sup> 0 mm ... 700 mm, through-beam system <sup>3)</sup>	0 mm ... 350 mm, proximity system <sup>1) 2)</sup> 0 mm ... 1,100 mm, through-beam system <sup>3)</sup>
<b>Type of light</b>	Visible red light	
<b>Light sender <sup>4)</sup></b>	LED	
<b>Wavelength</b>	632 nm	
<b>Setting</b>	Potentiometer, 8 rotations <sup>5)</sup>	Teach-in button Cable Plus/minus button
<b>Time type</b>	Without time delay, switch-off delay	Switch-on delay, switch-off delay, one-shot, without time delay
<b>Delay time</b>	Selectable using rotary switch, 0 ms, 40 ms	Programmable, 0 ms, 100 ms
<b>Display</b>	LED	Display
<b>Display</b>	Status LEDs	Status LEDs, 4-digit digital display, display can be selected between percentage value, absolute digit value and bar graph/display of the parameters

<sup>1)</sup> Object with 90% remission (based on standard white, DIN 5033).

<sup>2)</sup> NF-DK06.

<sup>3)</sup> NF-TB02.

<sup>4)</sup> Average service life: 100,000 h at  $T_u = +25\text{ °C}$ .

<sup>5)</sup> Sensitivity level 230°.

## Mechanics/electronics

	GLL170	GLL170T
<b>Supply voltage <sup>1)</sup></b>	10 V DC ... 30 V DC	
<b>Residual ripple <sup>2)</sup></b>	≤ 10%	
<b>Current consumption <sup>3)</sup></b>	≤ 30 mA	≤ 40 mA
<b>Switching output</b>	PNP/NPN (depending on type)	PNP/NPN (selectable via menu)
<b>Number of switching outputs</b>	1	
<b>Input</b>	-	Teach-in input
<b>Switching mode</b>	Light/dark switching	
<b>Selectable switching mode</b>	Selectable via rotary switch	Selectable via menu
<b>Output current <math>I_{max}</math>.</b>	≤ 100 mA	
<b>Response time <sup>4)</sup></b>	≤ 250 μs	≤ 250 μs ≤ 50 μs, selectable via menu
<b>Switching frequency</b>	2 kHz	2 kHz, 10 kHz
<b>Connection type</b>	Cable, 2 m <sup>5)</sup> Male connector, M8 (depending on type)	
<b>Circuit protection</b>	A <sup>6)</sup> , B <sup>7)</sup> , C <sup>8)</sup> , D <sup>9)</sup>	
<b>Protection class</b>	III	

	GLL170	GLL170T	
<b>Weight</b>	Cable, 3-wire	63 g	66 g
	Male connector, M8, 3-pin	19 g	22 g
	M8 male connector, 4-pin	19 g	22 g
<b>Housing material</b>	PC/POM		
<b>Max. tightening torque</b>	0.5 Nm		
<b>Enclosure rating <sup>10)</sup></b>	IP 66		
<b>Scope of delivery</b>	Mounting bracket BEF-WLL180		
<b>Ambient temperature, operation</b>	-25 °C ... +55 °C		
<b>Ambient temperature, storage</b>	-40 °C ... +70 °C		

<sup>1)</sup> Limit values.

<sup>2)</sup> Must not exceed or fall short of  $U_V$  tolerances.

<sup>3)</sup> Without load.

<sup>4)</sup> Signal propagation time with ohmic load.

<sup>5)</sup> Do not bend cables below 0 °C.

<sup>6)</sup> A =  $U_V$  connections reverse polarity protected.

<sup>7)</sup> B = inputs and outputs reverse-polarity protected.

<sup>8)</sup> C = Interference suppression.

<sup>9)</sup> D = outputs overcurrent and short-circuit protected.

<sup>10)</sup> With correctly attached LL3 fibers.

## Ordering information

Other device versions available here → [www.mysick.com/GLL170](http://www.mysick.com/GLL170)

### GLL170

Sensing range max.	Configuration <sup>4)</sup>	Switching mode	Connection	Connection diagram	Type	Part no.
0 mm ... 190 mm (proximity system) <sup>1) 2)</sup> 0 mm ... 800 mm (through-beam system) <sup>3)</sup>	Potentiometer, 8 rotations	PNP	Cable, 3-pin, 2 m	cd-043	GLL170-P332	6063334
			Male connector, M8, 3-pin	cd-045	GLL170-P333	6063336
			Male connector, M8, 4-pin	cd-066	GLL170-P334	6063335
		NPN	Cable, 3-pin, 2 m	cd-043	GLL170-N332	6063337
			Male connector, M8, 3-pin	cd-045	GLL170-N333	6063339
			Male connector, M8, 4-pin	cd-066	GLL170-N334	6063338

<sup>1)</sup> Object with 90% remission (based on standard white, DIN 5033).

<sup>2)</sup> NF-DK06.

<sup>3)</sup> NF-TB02.

<sup>4)</sup> Sensitivity level 230°.

### GLL170T

Sensing range max.	Setting	Switching mode	Connection	Connection diagram	Type	Part no.
0 mm ... 400 mm (proximity system) <sup>1) 2)</sup> 0 mm ... 1,320 mm (through-beam system) <sup>3)</sup>	Teach-in button Cable Plus/minus button	PNP, NPN	Cable, 4-pin, 2 m	cd-093	GLL170T-B432	6063340
			Male connector, M8, 3-pin	cd-045	GLL170T-B333	6063342
			Male connector, M8, 4-pin	cd-092	GLL170T-B434	6063341

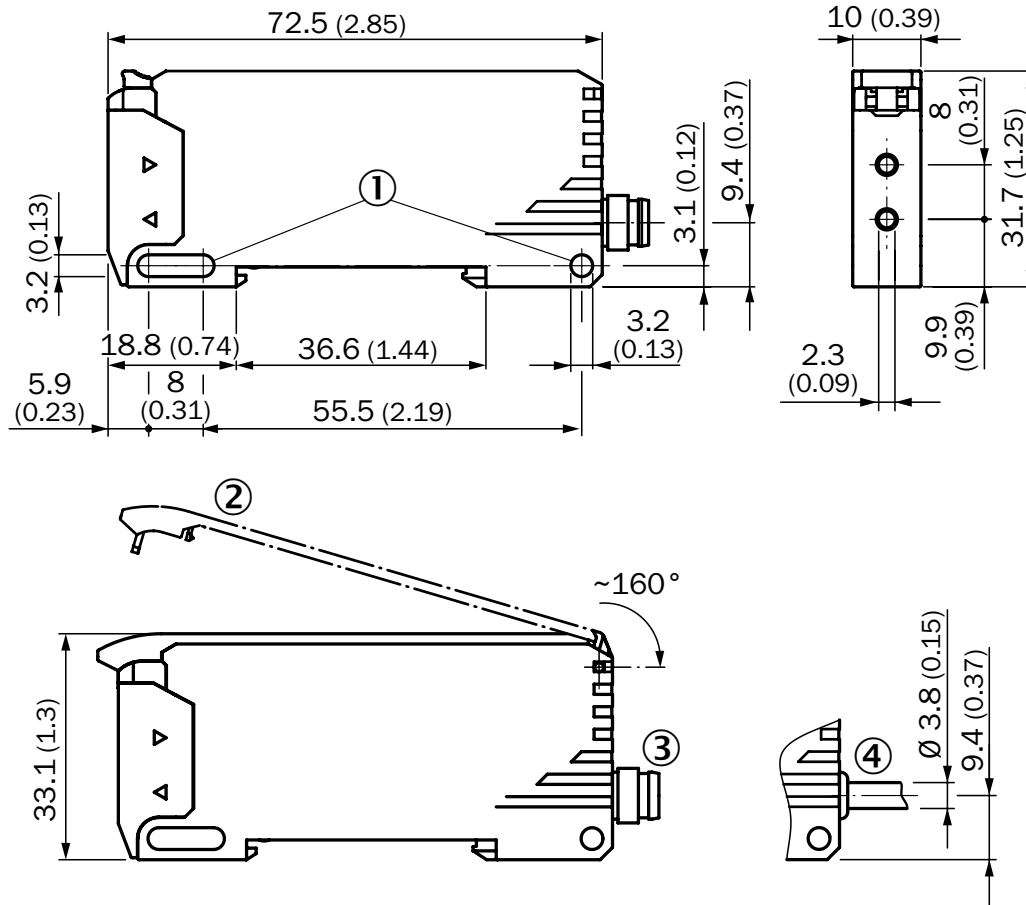
<sup>1)</sup> Object with 90% remission (based on standard white, DIN 5033).

<sup>2)</sup> NF-DK06.

<sup>3)</sup> NF-TB02.

D

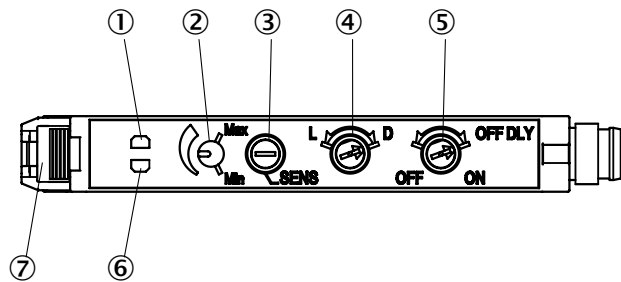
Dimensional drawing (dimensions in mm)



- ① Fixing holes
- ② Protective hood (optional) opens approx. 160°
- ③ Male connector, M8
- ④ Cable

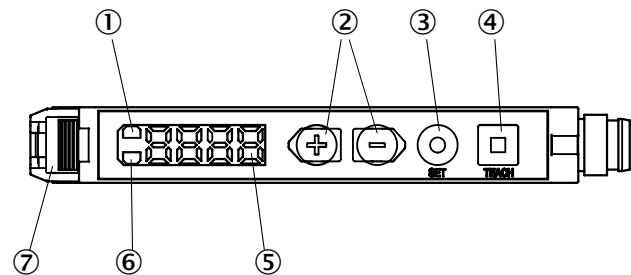
Adjustments

GLL170



- ① Orange LED indicator: Lights up when the switching output is active
- ② Sensitivity scale 230°
- ③ Sensitivity control: potentiometer, 8 rotations
- ④ Selector switch: "L.ON" (light switching) / "D.ON" (dark switching)
- ⑤ Selector switch for switch-off delay: "ON" / "OFF", 40 ms fixed
- ⑥ Green receive indicator LED: Lights up when light received < 0.9 or > 1.1 (switching threshold = 1)
- ⑦ Optical fiber interlocking

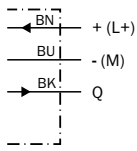
GLL170T



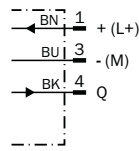
- ① Orange LED indicator: Lights up when the switching output is active
- ② Plus/minus button
- ③ SET button
- ④ Teach-in button
- ⑤ Display
- ⑥ Green LED indicator: Supply voltage active
- ⑦ Optical fiber interlocking

Connection diagram

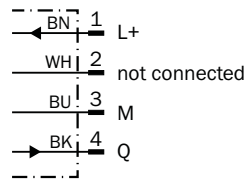
Cd-043



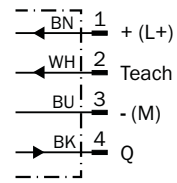
Cd-045



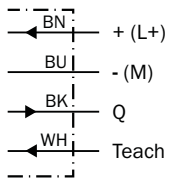
Cd-066



Cd-092



Cd-093



Recommended accessories

Mounting systems

Mounting brackets and plates

Figure	Material	Description	Type	Part no.
	Steel, zinc coated	Mounting bracket	BEF-WLL180	5325812

Other mounting accessories

Figure	Description	Type	Part no.
	Fiber cutting device, included in LL3 scope of delivery	FC	5304141
	Protective hood for GLL170, opens approx. 160°	BF-GLL170	5336263



Connectivity

Plug connectors and cables

Connecting cables with female connector

M8, 3-pin, PVC, resistant to chemicals



- **Cable material:** PVC
- **Material, plug connector:** TPU

Figure	Head A connection type	Head B connection type	Connecting cable	Material, knurled nut	Type	Part no.
	Female connector, M8, 3-pin, straight, unshielded	Cable, flying leads	2 m, 3-wire	CuZn, nickel-plated	YF8U13-020VA1XLEAX	2095860
			5 m, 3-wire	CuZn, nickel-plated	YF8U13-050VA1XLEAX	2095884
			10 m, 3-wire	CuZn, nickel-plated	YF8U13-100VA1XLEAX	2095885
	Female connector, M8, 3-pin, angled, unshielded	Cable, flying leads	2 m, 3-wire	CuZn, nickel-plated	YG8U13-020VA1XLEAX	2096165
			5 m, 3-wire	CuZn, nickel-plated	YG8U13-050VA1XLEAX	2096166
			10 m, 3-wire	CuZn, nickel-plated	YG8U13-100VA1XLEAX	2096209





M8, 4-pin, PVC, resistant to chemicals

- **Cable material:** PVC
- **Material, knurled nut:** CuZn, nickel-plated



Figure	Head A connection type	Head B connection type	Connecting cable	Material, plug connector	Type	Part no.
	Female connector, M8, 4-pin, straight, unshielded	Cable, flying leads	2 m, 4-wire	TPU	YF8U14-020VA3XLEAX	2095888
			5 m, 4-wire	TPU	YF8U14-050VA3XLEAX	2095889
			10 m, 4-wire	TPU	YF8U14-100VA3XLEAX	2095890
	Female connector, M8, 4-pin, angled, unshielded	Cable, flying leads	2 m, 4-wire	PVC	YG8U14-020VA3XLEAX	2095962
			5 m, 4-wire	PVC	YG8U14-050VA3XLEAX	2095963
			10 m, 4-wire	PVC	YG8U14-100VA3XLEAX	2095964

Female connector (ready to assemble)

M8, 3-pin


Figure	Head A connection type	Head B connection type	Material, plug connector	Material, knurled nut	Type	Part no.
	Female connector, M8, 3-pin, straight, unshielded	Screw terminals	PBT/PA	CuZn	DOS-0803-G	7902077
	Female connector, M8, 3-pin, angled, unshielded	Solder connection	PA/zinc die cast	CuZn	DOS-0803-W	7902078

M8, 4-pin


Figure	Head A connection type	Head B connection type	Material, plug connector	Material, knurled nut	Type	Part no.
	Female connector, M8, 4-pin, straight, unshielded	Screw terminals	PBT/PA	CuZn	DOS-0804-G	6009974
	Female connector, M8, 4-pin, angled, unshielded	Solder connection	PA/zinc die cast	CuZn	DOS-0804-W	6009975

Male connector (ready to assemble)

M8, 3-pin

Figure	Head A connection type	Head B connection type	Material, plug connector	Material, knurled nut	Type	Part no.
	Male connector, M8, 3-pin, straight, unshielded	Screw terminals	PBT/PA	CuZn	STE-0803-G	6037322

M8, 4-pin

Figure	Head A connection type	Head B connection type	Material, plug connector	Material, knurled nut	Type	Part no.
	Male connector, M8, 4-pin, straight, unshielded	Screw terminals	PBT/PA	CuZn	STE-0804-G	6037323

Dimensional drawings → [Page F-114](#)

A further selection of accessories can be found here → [E-104](#)



# A GLOBAL LEADER WHEN IT COMES TO SENSING RANGE AND PERFORMANCE



## Product description

The WLL180T provides the world's fastest response time - only 16  $\mu$ s. At the same time, the sensor offers maximum values for sensing range and operating reserve due to its high light intensity and resolution. This considerably increases process reliability, for example when used in dusty or moist environments. Commissioning is simple - either via the external teach-in input or directly on the unit. All programming steps, status displays, and target and actual values

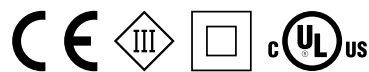
are shown on two four-digit displays. The WLL180T can be operated either as a stand-alone sensor or in a bus configuration, depending on your requirements. In a bus configuration, several sensors are networked via an internal bus, enabling the settings on one WLL180T to be copied to all other devices on the bus. Mutual interference by fiber-optic heads installed in close proximity is prevented by the integrated anti-interference logic.

## At a glance

- Selectable response time up to 16  $\mu$ s
- Sensing range up to 20 m (through-beam system); up to 1400 mm (proximity system)
- Bus-compatible with anti-interference
- 2 x 4-digit digital display
- Adjustable hysteresis
- Rotatable display screen
- High-resolution signal processing
- Programmable time delays

## Your benefits

- Reliable, rapid process detection
- Workpieces are detected reliably, even under the most difficult of ambient conditions such as dust or spray mist
- No mutual effects from fiber-optic cable heads mounted in close proximity on account of bus communication
- Easy monitoring of process parameters
- Hysteresis can be adapted to suit the application, e.g., when detecting tiny or transparent objects
- Easy-to-read display, even under difficult installation conditions



## More information

- Detailed technical data.....D-99
- Ordering information.....D-100
- Dimensional drawings.....D-101
- Adjustments.....D-102
- Connection diagram.....D-102
- Recommended accessories.....D-102

→ [www.sick.com/WLL180T](http://www.sick.com/WLL180T)

For more information, simply enter the link or scan the QR code to get direct access to technical data, CAD design models, operating instructions, software, application examples, and much more.



D

## Detailed technical data

### Features

	Visible red light	Infrared light
<b>Sensor principle</b>	Fiber-optic sensor	
<b>Device type</b>	Standalone Base unit <sup>1)</sup> Expansion unit (depending on type)	Standalone
<b>Dimensions (W x H x D)</b>	10.5 mm x 34.6 mm x 71.9 mm	
<b>Housing design (light emission)</b>	Cuboid	
<b>Sensing range max.</b>	0 m ... 20 m, through-beam system <sup>2) 3)</sup>	0 mm ... 1,000 mm, through-beam system <sup>2) 4)</sup>
<b>Sensing range</b>	0 mm ... 1,400 mm, proximity system <sup>5) 6)</sup> 0 ... 18 m, through-beam system <sup>2) 3)</sup>	0 mm ... 400 mm, proximity system <sup>5) 7)</sup> 0 m ... 850 mm, through-beam system <sup>2) 4)</sup>
<b>Type of light</b>	Visible red light	Infrared light
<b>Light sender <sup>9)</sup></b>	LED	
<b>Wavelength</b>	650 nm	1,450 nm
<b>Setting</b>	Menu-controlled Single teach-in button Cable (depending on type)	
<b>Time type</b>	Without time delay, switch off delay, on delay, switch on and off delay, one-shot	
<b>Delay time</b>	Programmable, 0 ms, 9,999 ms	
<b>Display</b>	Display	
<b>Display</b>	LED status display, 2x 4-digit digital dual display, target value (green) and actual value (red) are displayed at the same time, display of the parameters	

<sup>1)</sup> Up to 15 expansion units can be connected.

<sup>2)</sup> Sensing range at 8 ms response time. Reduced at shorter response times (see LL3/WLL180T tables).

<sup>3)</sup> LL3-TX01.

<sup>4)</sup> LL3-TW01.

<sup>5)</sup> Object with 90% remission (based on standard white, DIN 5033). Sensing range at 8 ms response time. Reduced at shorter response times (see LL3/WLL180T tables).

<sup>6)</sup> LL3-DK06.

<sup>7)</sup> LL3-DW01.

<sup>8)</sup> See LL3 fiber data.

<sup>9)</sup> Average service life: 100,000 h at  $T_u = +25\text{ °C}$ .

### Mechanics/electronics

	Visible red light	Infrared light
<b>Supply voltage <sup>1)</sup></b>	12 V DC ... 24 V DC	
<b>Residual ripple <sup>2)</sup></b>	≤ 10%	
<b>Current consumption <sup>3)</sup></b>	≤ 50 mA	
<b>Switching output</b>	PNP/NPN (depending on type)	
<b>Number of switching outputs</b>	1	
<b>input</b>	Multifunction input MF / - (depending on type)	
<b>Switching mode</b>	Light/dark switching function (can be selected manually)	
<b>Output current <math>I_{max}</math>.</b>	< 100 mA	
<b>Response time <sup>4)</sup></b>	≤ 16 μs, ≤ 70 μs, ≤ 250 μs, ≤ 2,000 μs, ≤ 8,000 μs	
<b>Switching frequency</b>	31.2 kHz, 7.1 kHz, 2 kHz, 250 Hz, 62.5 Hz	
<b>Connection type</b>	Cable, 2 m <sup>5)</sup> , male connector, M8 (depending on type)	
<b>Circuit protection</b>	A <sup>6)</sup> , B <sup>7)</sup> , C <sup>8)</sup> , D <sup>9)</sup>	
<b>Protection class</b>	III	

<b>Weight</b>	Cable, 4-wire	25 g	-
	M8 male connector, 4-pin	20 g	-
	Cable, 2-wire	25 g	-
<b>Housing material</b>	ABS/PC		
<b>Enclosure rating <sup>10)</sup></b>	IP 50		
<b>Scope of delivery</b>	Mounting bracket BEF-WLL180		
<b>Ambient temperature, operation</b>	-25 °C ... +55 °C <sup>11)</sup> (depending on type)		
<b>Ambient temperature, storage</b>	-40 °C ... +70 °C		

<sup>1)</sup> +- 10%.

<sup>2)</sup> Must not exceed or fall short of  $U_V$  tolerances.

<sup>3)</sup> Without load.

<sup>4)</sup> Can be selected.

<sup>5)</sup> Do not bend cables below 0 °C.

<sup>6)</sup> A =  $U_V$  connections reverse polarity protected.

<sup>7)</sup> B = inputs and outputs reverse-polarity protected.

<sup>8)</sup> C = Interference suppression.

<sup>9)</sup> D = outputs overcurrent and short-circuit protected.

<sup>10)</sup> With correctly attached LL3 fibers and closed protection hood.

<sup>11)</sup> Operating temperature varies according to the number of devices connected: 4-8 devices: -25 °C ... +50 °C (output current 50 mA) / 9-16 devices: -25 °C ... +45 °C (output current 20 mA).

## Ordering information

Other device versions available here → [www.sick.com/WLL180T](http://www.sick.com/WLL180T)

## Visible red light

- **Max sensing range:** 0 m to 20 m, through-beam system (sensing range at 8 ms response time. Reduced at shorter response times (see LL3/WLL180T tables))

D

Device type	Setting	Switching output	Connection	Connection diagram	Type	Part no.
Standalone	Menu-controlled Single teach-in button Cable	PNP	Cable, 4-wire, 2 m	cd-136	WLL180T-P432	6039093
			Male connector, M8, 4-pin	cd-134	WLL180T-P434	6039095
		NPN	Cable, 4-wire, 2 m	cd-136	WLL180T-N432	6039094
			Male connector, M8, 4-pin	cd-134	WLL180T-N434	6039096
Base unit	Menu-controlled Single teach-in button Cable	PNP	Cable, 4-wire, 2 m	cd-138	WLL180T-M432	6039097
			Male connector, M8, 4-pin	cd-140	WLL180T-M434	6039101
		NPN	Cable, 4-wire, 2 m	cd-138	WLL180T-L432	6039099
			Male connector, M8, 4-pin	cd-140	WLL180T-L434	6039103
	Menu-controlled Single teach-in button	PNP	Male connector, M8, 3-pin	cd-045	WLL180T-M333	6042428
		NPN	Male connector, M8, 3-pin	cd-045	WLL180T-L333	6049837
Expansion unit	Menu-controlled Single teach-in button Cable	PNP	Cable, 2-wire, 2 m	cd-138	WLL180T-F232	6039098
			Male connector, M8, 4-pin	cd-140	WLL180T-F434	6039102
		NPN	Cable, 2-wire, 2 m	cd-138	WLL180T-E232	6039100
			Male connector, M8, 4-pin	cd-140	WLL180T-E434	6039104
	Menu-controlled Single teach-in button	PNP	Male connector, M8, 3-pin	cd-362	WLL180T-F333	6042429
		NPN	Male connector, M8, 3-pin	cd-045	WLL180T-E333	6049838

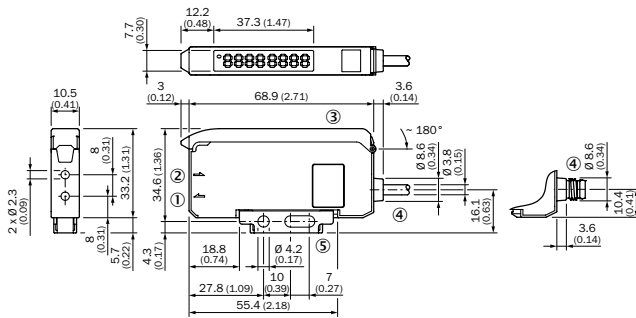
Infrared light

- **Max sensing range:** 0 m to 1000 mm, through-beam system (sensing range at 8 ms response time. Reduced at shorter response times (see LL3/WLL180T tables))

Device type	Setting	Switching output	Connection	Connection diagram	Type	Part no.
Standalone	Menu-controlled Single teach-in button Cable	PNP	Male connector, M8, 4-pin	cd-134	WLL180T-P474	6039618
		NPN	Male connector, M8, 4-pin	cd-134	WLL180T-N474	6039619

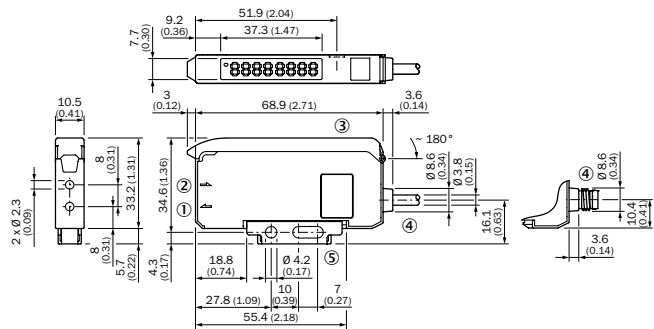
Dimensional drawings (dimensions in mm)

Standalone



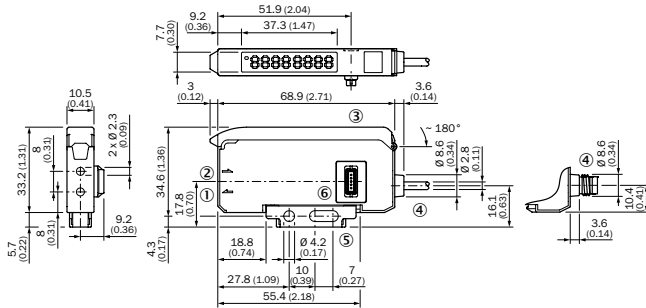
- ① LED emitter, installation of LL3 (emitter fiber)
- ② Receiver, installation of LL3 fibers (receiver fiber)
- ③ Protective hood opens approx. 180°
- ④ Connection
- ⑤ Mounting bracket, included in scope of delivery

Bus version



- ① LED emitter, installation of LL3 (emitter fiber)
- ② Receiver, installation of LL3 fibers (receiver fiber)
- ③ Protective hood opens approx. 180°
- ④ Connection
- ⑤ Mounting bracket, included in scope of delivery

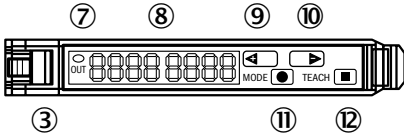
Expansion unit



- ① LED emitter, installation of LL3 (emitter fiber)
- ② Receiver, installation of LL3 fibers (receiver fiber)
- ③ Protective hood opens approx. 180°
- ④ Connection
- ⑤ Mounting bracket, included in scope of delivery
- ⑥ Bus male connector



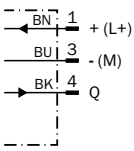
### Adjustments



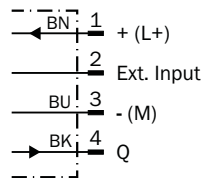
- ③ Fiber-optic locking mechanism
- ⑦ Orange LED indicator: Lights up when the switching output is active
- ⑧ Numeric display 2 x 4 digit; green: switching threshold, operating mode; red: actual value, teach-in/function parameter
- ⑨ Step button > (manual switching threshold: higher/next function parameter)
- ⑩ Step button < (manual switching threshold: lower/previous function parameter)
- ⑪ Mode/enter button (programming button)
- ⑫ Teach-in button

### Connection diagram

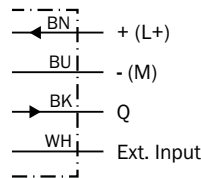
Cd-045



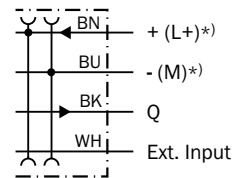
Cd-134



Cd-136

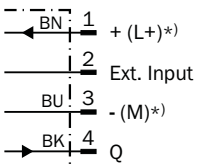


Cd-138



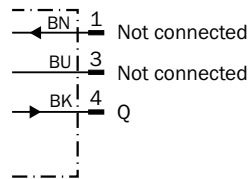
\*) Only base unit

Cd-140



\*) Only base unit

Cd-362



D

### Recommended accessories

#### Mounting systems

##### Mounting brackets and plates

Figure	Material	Description	Type	Part no.
	Steel, zinc coated	Mounting bracket	BEF-WLL180	5325812

##### Other mounting accessories

Figure	Description	Type	Part no.
	Rail end cap for block mounting, stainless steel, incl. mounting hardware	BF-EB01-W190	5313011
	Fiber cutting device, included in LL3 scope of delivery	FC	5304141



## Connectivity

Plug connectors and cables

Connecting cables with female connector



M8, 3-pin, PVC, resistant to chemicals

- **Cable material:** PVC
- **Material, plug connector:** TPU

Figure	Head A connection type	Head B connection type	Connecting cable	Material, knurled nut	Type	Part no.
	Female connector, M8, 3-pin, straight, unshielded	Cable, flying leads	2 m, 3-wire	CuZn, nickel-plated	YF8U13-020VA1XLEAX	2095860
			5 m, 3-wire	CuZn, nickel-plated	YF8U13-050VA1XLEAX	2095884
	Female connector, M8, 3-pin, angled, unshielded	Cable, flying leads	2 m, 3-wire	CuZn, nickel-plated	YG8U13-020VA1XLEAX	2096165
			5 m, 3-wire	CuZn, nickel-plated	YG8U13-050VA1XLEAX	2096166

M8, 4-pin, PVC, resistant to chemicals

- **Cable material:** PVC
- **Material, knurled nut:** CuZn, nickel-plated

Figure	Head A connection type	Head B connection type	Connecting cable	Material, plug connector	Type	Part no.
	Female connector, M8, 4-pin, straight, unshielded	Cable, flying leads	2 m, 4-wire	TPU	YF8U14-020VA3XLEAX	2095888
			5 m, 4-wire	TPU	YF8U14-050VA3XLEAX	2095889
	Female connector, M8, 4-pin, angled, unshielded	Cable, flying leads	2 m, 4-wire	PVC	YG8U14-020VA3XLEAX	2095962
			5 m, 4-wire	PVC	YG8U14-050VA3XLEAX	2095963

A further selection of accessories can be found here → [E-104](#)





## SENSORS AND ACCESSORIES FROM SICK

A perfect match: For optimal integration of sensors in your systems, the use of perfectly matched accessories is indispensable.

Reliable signal transmission guarantees productivity – high-quality connectivity components with long service life reduce costs. With this in mind, SICK

provides suitable connection technology for every application and industry. The comprehensive range of plug connectors provides the right cabling for every application.

When it comes to mounting and adapting the sensors, SICK has the ideal solution.

E



**Mounting systems . . . . . E-106**

**Reflectors and optics. . . . . E-107**

**Connectivity. . . . . E-108**

**Dimensional drawings for fibers and tip adapters. . . . . F-114**

**Index. . . . . G-150**

**E**




Accessories

Mounting systems

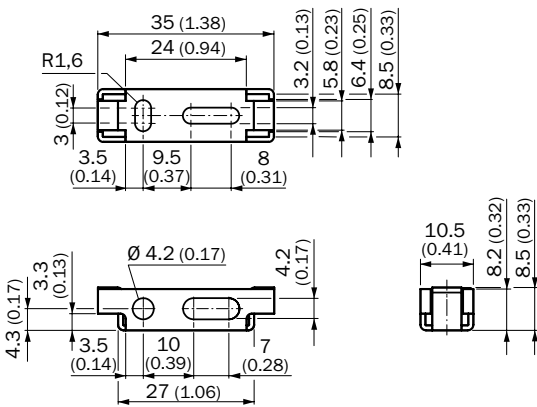
Mounting brackets and plates

Mounting bracket

- **Description:** Mounting bracket







Figure	Material	Type	Part no.	GLL170	WLL180T
	Steel, zinc coated	BEF-WLL180	5325812	●	●

BEF-WLL180



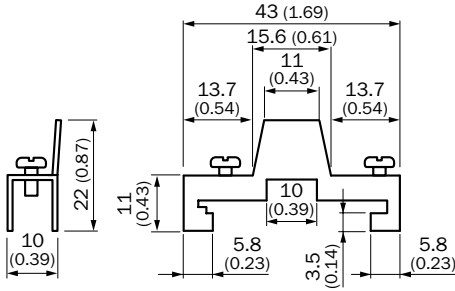
Other mounting accessories

Other info

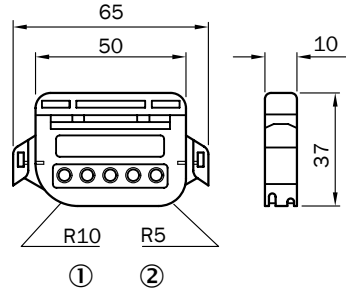
Figure	Brief description	Type	Part no.	LL3	GLL170	WLL180T
	Rail end cap for block mounting, stainless steel, incl. mounting hardware	BF-EB01-W190	5313011	-	-	●
	Adapter sleeve for Ø 1.0 mm LL3 fiber, included in LL3 scope of delivery	BF-WLL160-10	5305479	●	-	-
	Adapter sleeve for Ø 1.3 mm LL3 fiber, included in LL3 scope of delivery	BF-WLL160-13	5306094	●	-	-
	Fiber cutting device, included in LL3 scope of delivery	FC	5304141	●	-	-
	Protective metal sheathing for LL3 fiber with M6 threaded head; length 500 mm	BEF-LL3M6500	5331290	●	-	-
	Protective metal sheathing for LL3 fiber with M6 threaded head; length 1000 mm	BEF-LL3M61000	5331291	●	-	-

E

BF-EB01-W190

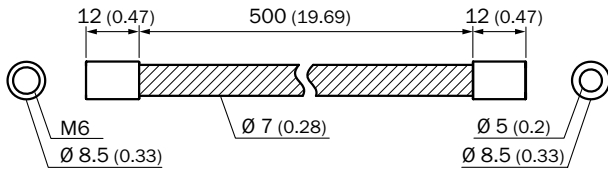


FC

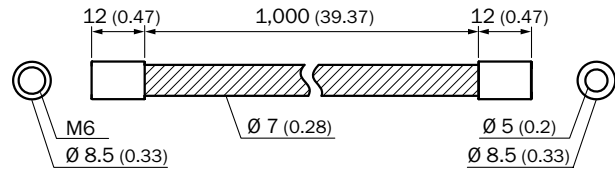


- ① Template for R10 mm bend radius for end sleeves of  $\varnothing$  1.5 mm and  $\varnothing$  2.5 mm
- ② R5 mm bend radius

BEF-LL3M6500



BEF-LL3M61000

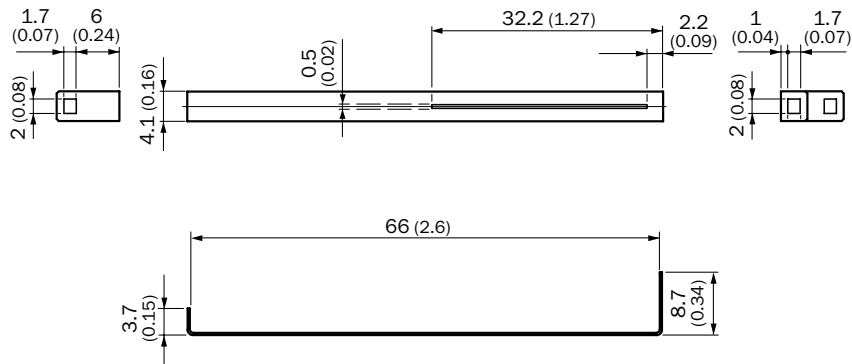


Reflectors and optics

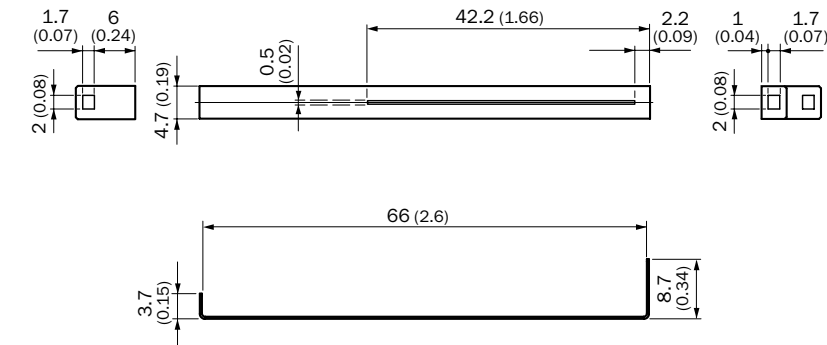
Diaphragms

Material	Description	Type	Part no.	LL3
Stainless steel	Mask, 0.5 mm x 30 mm, for LL3-TS40	BL-TS40-30	5324719	●
	Mask, 0.5 mm x 40 mm, for LL3-TS40	BL-TS40-40	5334439	●

BL-TS40-30



BL-TS40-40





Connectivity

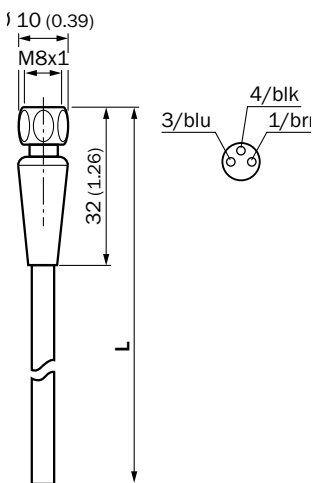
Plug connectors and cables

Connecting cables with M8 female connector, 3-pin, PP, hygiene applications

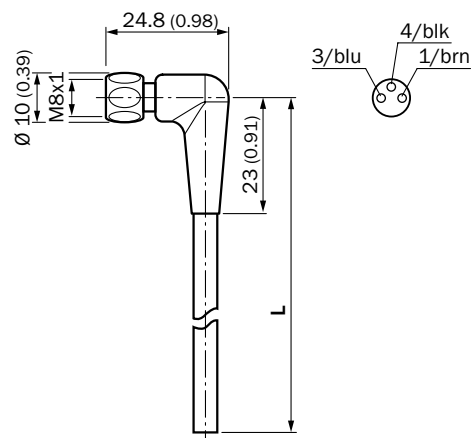
- **Cable material:** PP
- **Material, plug connector:** PP
- **Material, knurled nut:** stainless steel (V4A/1.4404/316L)

Figure	Head A connection type	Head B connection type	Connecting cable	Type	Part no.	GLL170	WLL180T
						●	●
	Female connector, M8, 3-pin, straight, unshielded	Cable, flying leads	2 m, 3-wire	DOL-0803-G02MRN	6058504	●	●
			5 m, 3-wire	DOL-0803-G05MRN	6058505	●	●
			10 m, 3-wire	DOL-0803-G10MRN	6058506	●	●
	Female connector, M8, 3-pin, angled, unshielded	Cable, flying leads	2 m, 3-wire	DOL-0803-W02MRN	6058507	●	●
			5 m, 3-wire	DOL-0803-W05MRN	6058508	●	●
			10 m, 3-wire	DOL-0803-W10MRN	6058509	●	●

DOL-0803-GxxMRN





DOL-0803-WxxMRN



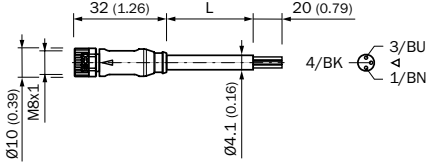
Connecting cables with M8 female connector, 3-pin, PUR, halogen-free, resistant to oil/lubricants

- **Cable material:** PUR, halogen-free
- **Material, plug connector:** TPU
- **Material, knurled nut:** nickel plated zinc die cast

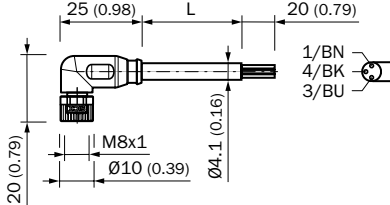


Figure	Head A connection type	Head B connection type	Connecting cable	Type	Part no.	GLL170	WLL180T
						●	●
	Female connector, M8, 3-pin, straight, unshielded	Cable, flying leads	1 m, 3-wire	YF8U13-010UA1XLEAX	2094779	●	●
			2 m, 3-wire	YF8U13-020UA1XLEAX	2094782	●	●
			3 m, 3-wire	YF8U13-030UA1XLEAX	2094787	●	●
			5 m, 3-wire	YF8U13-050UA1XLEAX	2094788	●	●
			10 m, 3-wire	YF8U13-100UA1XLEAX	2094789	●	●
			20 m, 3-wire	YF8U13-200UA1XLEAX	2094790	●	●
	Female connector, M8, 3-pin, angled, unshielded	Cable, flying leads	2 m, 3-wire	YG8U13-020UA1XLEAX	2094794	●	●
			5 m, 3-wire	YG8U13-050UA1XLEAX	2095586	●	●
			10 m, 3-wire	YG8U13-100UA1XLEAX	2095588	●	●

YF8U13-xxxUA1XLEAX



YG8U13-xxxUA1XLEAX

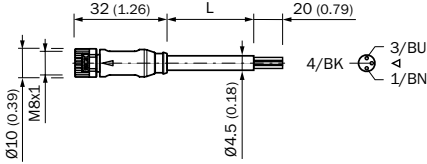


Connecting cables with M8 female connector, 3-pin, PVC, resistant to chemicals

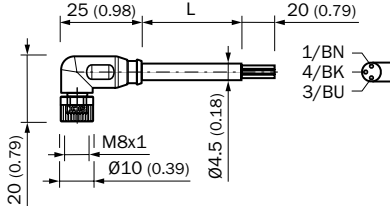
- **Cable material:** PVC
- **Material, plug connector:** TPU
- **Material, knurled nut:** CuZn, nickel-plated

Figure	Head A connection type	Head B connection type	Connecting cable	Type	Part no.	GLL170	WLL180T
	Female connector, M8, 3-pin, straight, unshielded	Cable, flying leads	2 m, 3-wire	YF8U13-020VA1XLEAX	2095860	●	●
			5 m, 3-wire	YF8U13-050VA1XLEAX	2095884	●	●
			10 m, 3-wire	YF8U13-100VA1XLEAX	2095885	●	●
			15 m, 3-wire	YF8U13-150VA1XLEAX	2095886	●	●
	Female connector, M8, 3-pin, angled, unshielded	Cable, flying leads	2 m, 3-wire	YG8U13-020VA1XLEAX	2096165	●	●
			5 m, 3-wire	YG8U13-050VA1XLEAX	2096166	●	●
			10 m, 3-wire	YG8U13-100VA1XLEAX	2096209	●	●
			15 m, 3-wire	YG8U13-150VA1XLEAX	2096210	●	●

YF8U13-xxxVA1XLEAX



YG8U13-xxxVA1XLEAX



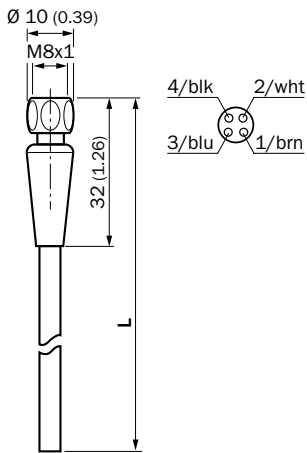
Connecting cables with M8 female connector, 4-pin, PP, hygiene applications

- **Cable material:** PP
- **Material, plug connector:** PP
- **Material, knurled nut:** stainless steel (V4A/1.4404/316L)

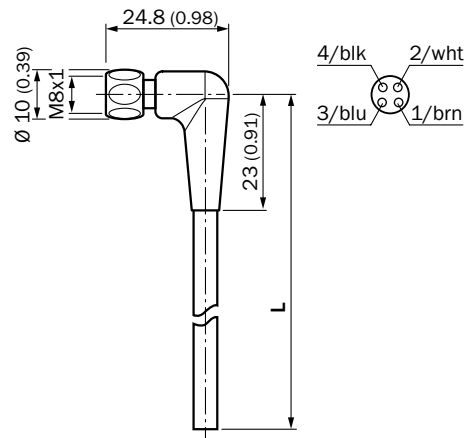
Figure	Head A connection type	Head B connection type	Connecting cable	Type	Part no.	GLL170	WLL180T
	Female connector, M8, 4-pin, straight, unshielded	Cable, flying leads	2 m, 4-wire	DOL-0804-G02MRN	6058510	●	●
			5 m, 4-wire	DOL-0804-G05MRN	6058511	●	●
			10 m, 4-wire	DOL-0804-G10MRN	6058512	●	●
			25 m, 4-wire	DOL-0804-G25MRN	6058513	●	●
	Female connector, M8, 4-pin, angled, unshielded	Cable, flying leads	2 m, 4-wire	DOL-0804-W02MRN	6058514	●	●
			5 m, 4-wire	DOL-0804-W05MRN	6058515	●	●
			10 m, 4-wire	DOL-0804-W10MRN	6058517	●	●
			25 m, 4-wire	DOL-0804-W25MRN	6058518	●	●



DOL-0804-GxxMRN



DOL-0804-WxxMRN



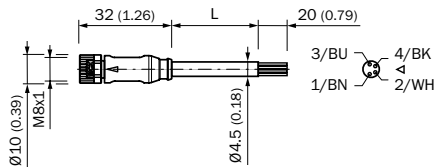
Connecting cables with M8 female connector, 4-pin, PUR, halogen-free, resistant to oil/lubricants

- **Cable material:** PUR, halogen-free
- **Material, plug connector:** TPU
- **Material, knurled nut:** nickel plated zinc die cast

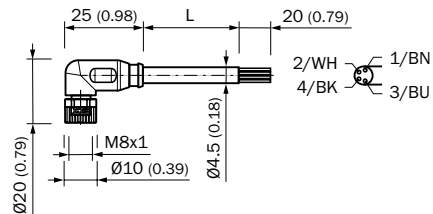
Figure	Head A connection type	Head B connection type	Connecting cable	Type	Part no.	GLL170	WLL180T
	Female connector, M8, 4-pin, straight, shielded	Cable, flying leads	5 m, 4-wire	YF8UA4-050UB4XLEAX	2096200	●	●
			10 m, 4-wire	YF8UA4-100UB4XLEAX	2096201	●	●
	Female connector, M8, 4-pin, straight, unshielded	Cable, flying leads	2 m, 4-wire	YF8U14-020UA3XLEAX	2094791	●	●
			5 m, 4-wire	YF8U14-050UA3XLEAX	2094792	●	●
			10 m, 4-wire	YF8U14-100UA3XLEAX	2094793	●	●
			15 m, 4-wire	YF8U14-150UA3XLEAX	2095580	●	●
			20 m, 4-wire	YF8U14-200UA3XLEAX	2095582	●	●
	Female connector, M8, 4-pin, angled, unshielded	Cable, flying leads	2 m, 4-wire	YG8U14-020UA3XLEAX	2095589	●	●
			5 m, 4-wire	YG8U14-050UA3XLEAX	2095590	●	●
			10 m, 4-wire	YG8U14-100UA3XLEAX	2095591	●	●

E

YF8U14-xxxUA3XLEAX





YG8U14-xxxUA3XLEAX

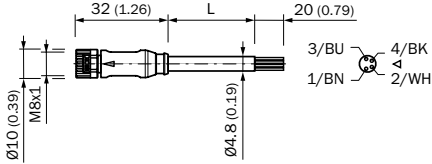


Connecting cables with M8 female connector, 4-pin, PVC, resistant to chemicals

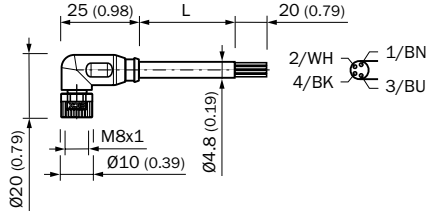
- **Cable material:** PVC
- **Material, knurled nut:** CuZn, nickel-plated

Figure	Head A connection type	Head B connection type	Connecting cable	Material, plug connector	Type	Part no.	GLL170	WLL180T
	Female connector, M8, 4-pin, straight, unshielded	Cable, flying leads	2 m, 4-wire	TPU	YF8U14-020VA3XLEAX	2095888	●	●
			3 m, 4-wire	TPU	YF8U14-030VA3XLEAX	2095896	●	●
			5 m, 4-wire	TPU	YF8U14-050VA3XLEAX	2095889	●	●
			10 m, 4-wire	TPU	YF8U14-100VA3XLEAX	2095890	●	●
			1.5 m, 4-wire	TPU	YF8U14-015VA3XLEAX	2095894	●	●
			2.5 m, 4-wire	TPU	YF8U14-025VA3XLEAX	2095876	●	●
	Female connector, M8, 4-pin, angled, unshielded	Cable, flying leads	2 m, 4-wire	PVC	YG8U14-020VA3XLEAX	2095962	●	●
			5 m, 4-wire	PVC	YG8U14-050VA3XLEAX	2095963	●	●
			10 m, 4-wire	PVC	YG8U14-100VA3XLEAX	2095964	●	●

YF8U14-xxxVA3XLEAX





YG8U14-xxxVA3XLEAX

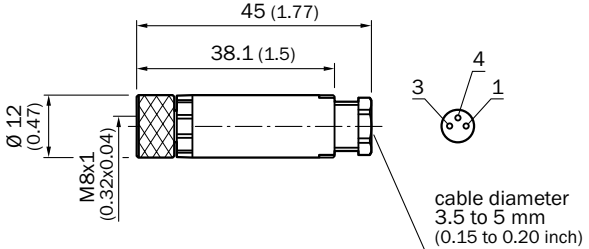


Female connectors (ready to assemble), M8, 3-pin

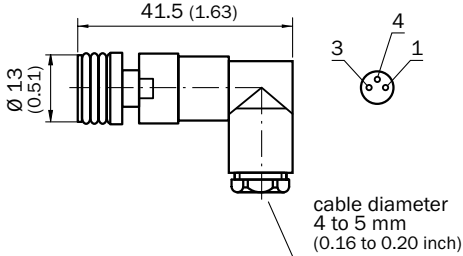
- **Material, knurled nut:** CuZn

Figure	Head A connection type	Head B connection type	Material, plug connector	Type	Part no.	GLL170	WLL180T
	Female connector, M8, 3-pin, straight, unshielded	Screw terminals	PBT/PA	DOS-0803-G	7902077	●	●
	Female connector, M8, 3-pin, angled, unshielded	Solder connection	PA/zinc die cast	DOS-0803-W	7902078	●	●

DOS-0803-G





DOS-0803-W

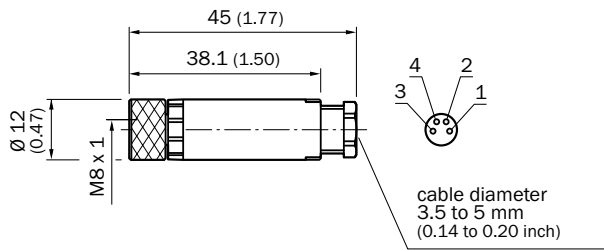


Female connectors (ready to assemble), M8, 4-pin

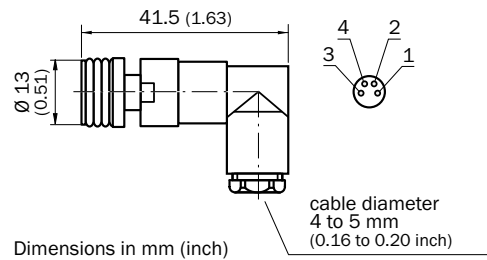
- **Material, knurled nut:** CuZn

Figure	Head A connection type	Head B connection type	Material, plug connector	Type	Part no.	GLL170	WLL180T
	Female connector, M8, 4-pin, straight, unshielded	Screw terminals	PBT/PA	DOS-0804-G	6009974	●	●
	Female connector, M8, 4-pin, angled, unshielded	Solder connection	PA/zinc die cast	DOS-0804-W	6009975	●	●


DOS-0804-G



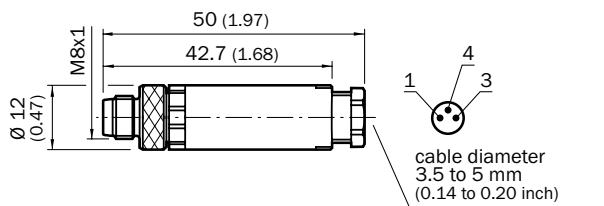
DOS-0804-W



Male connectors (ready to assemble), M8, 3-pin


Figure	Head A connection type	Head B connection type	Material, plug connector	Material, knurled nut	Type	Part no.	GLL170	WLL180T
	Male connector, M8, 3-pin, straight, unshielded	Screw terminals	PBT/PA	CuZn	STE-0803-G	6037322	●	●

STE-0803-G

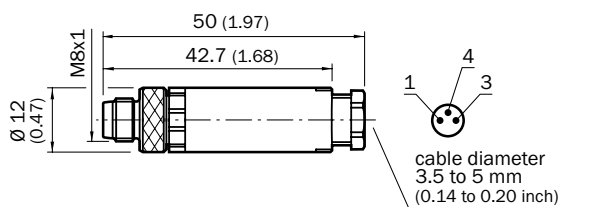


E

Male connectors (ready to assemble), M8, 4-pin

Figure	Head A connection type	Head B connection type	Material, plug connector	Material, knurled nut	Type	Part no.	GLL170	WLL180T
	Male connector, M8, 4-pin, straight, unshielded	Screw terminals	PBT/PA	CuZn	STE-0804-G	6037323	●	●

STE-0804-G



**E**

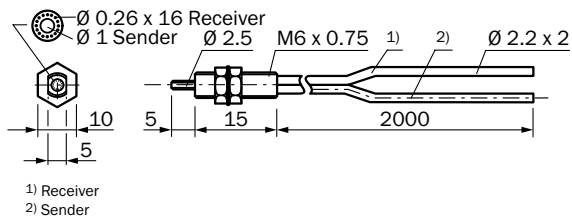


Dimensional drawings (dimensions in mm)

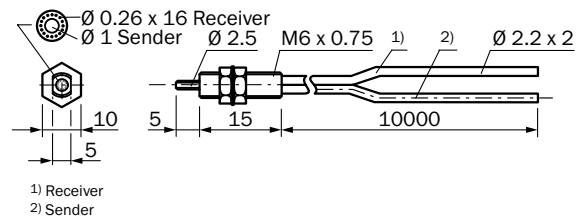


Fiber-optic proximity systems

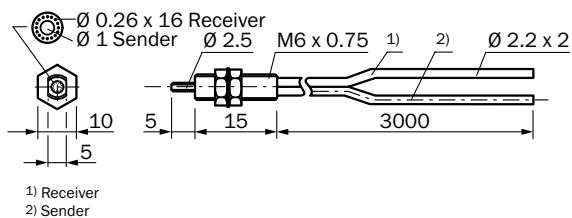
LL3-DB01



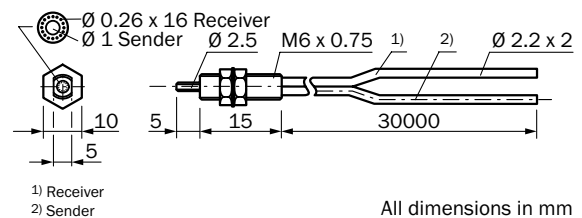
LL3-DB01-10



LL3-DB01-03

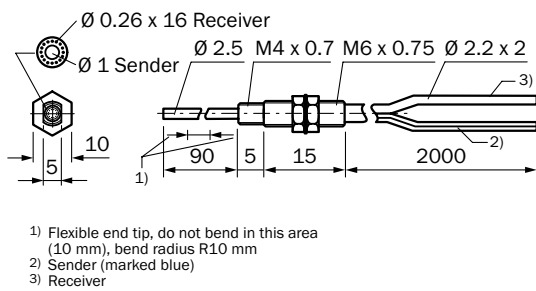


LL3-DB01-30

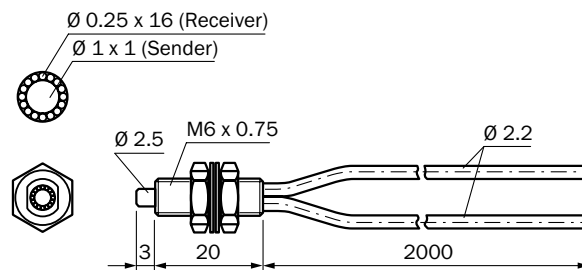


All dimensions in mm

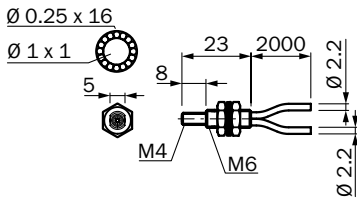
LL3-DB02



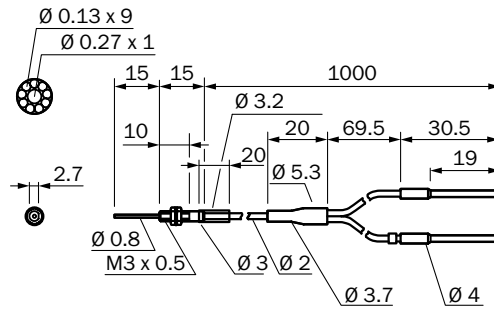
LL3-DB03



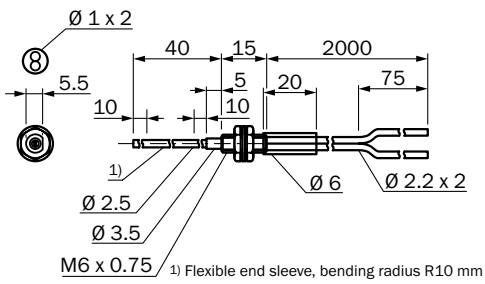
LL3-DB04



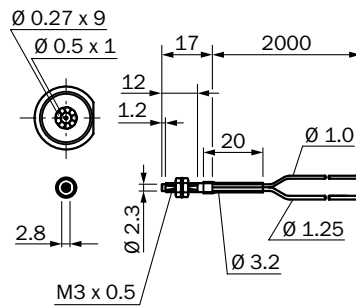
LL3-DB05



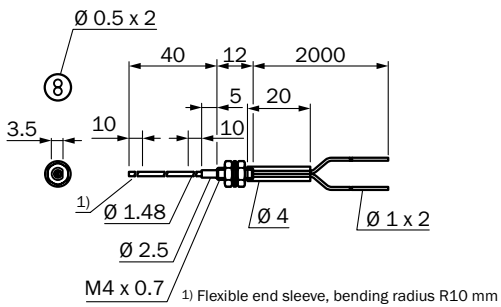
LL3-DB06



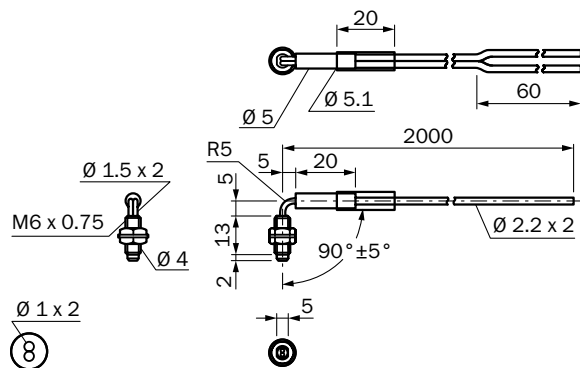
LL3-DB07



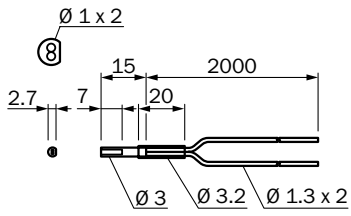
LL3-DB08



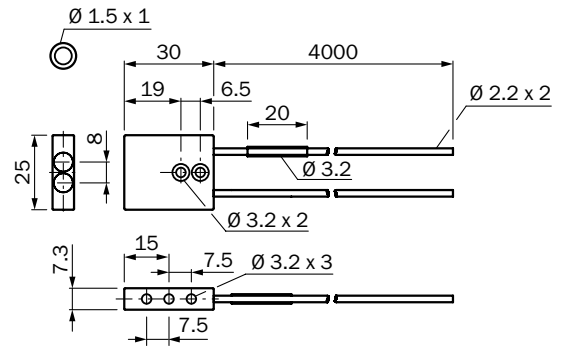
LL3-DB09



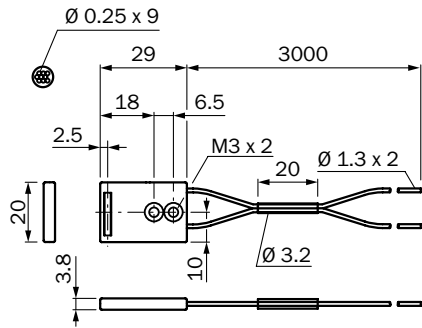
LL3-DB10



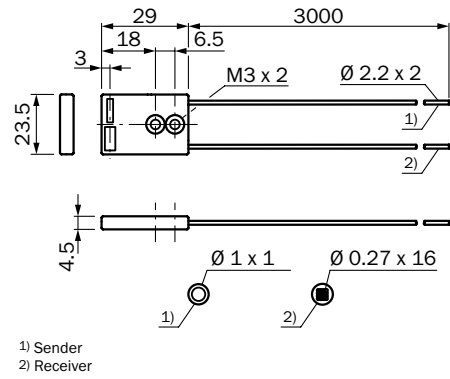
LL3-DC03



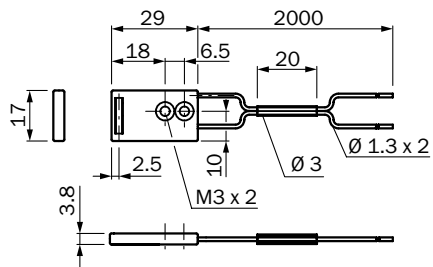
LL3-DC04



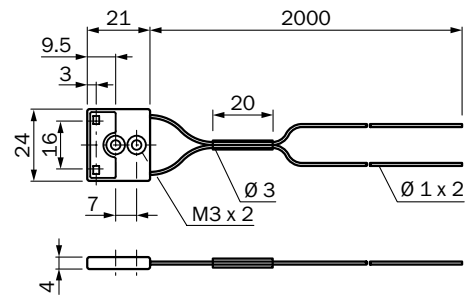
LL3-DC05



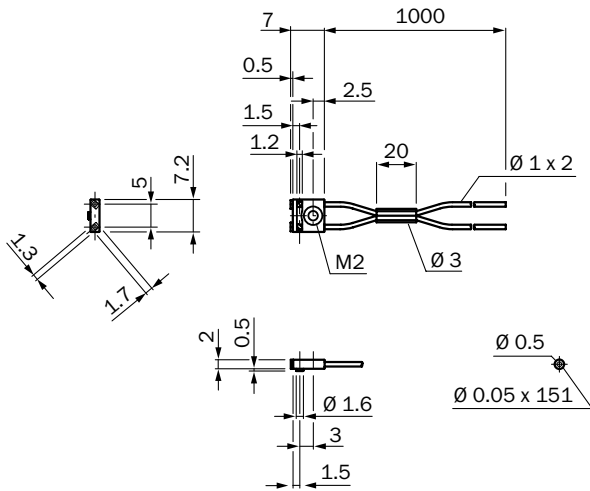
LL3-DC06



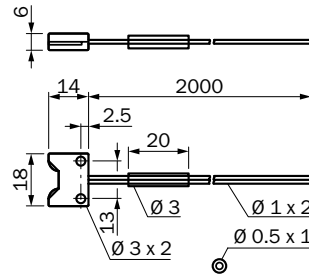
LL3-DC07



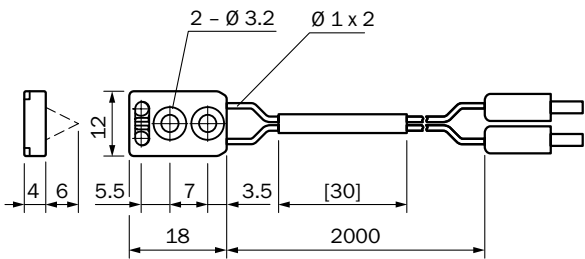
LL3-DC08



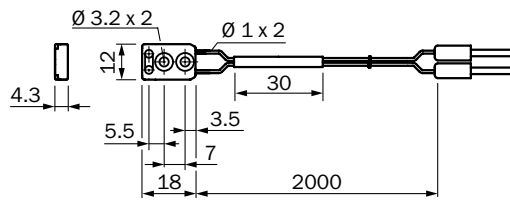
LL3-DC09



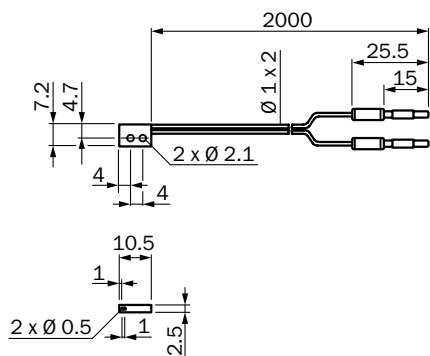
LL3-DC38



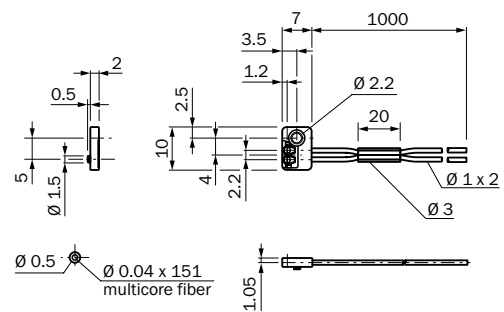
LL3-DC39



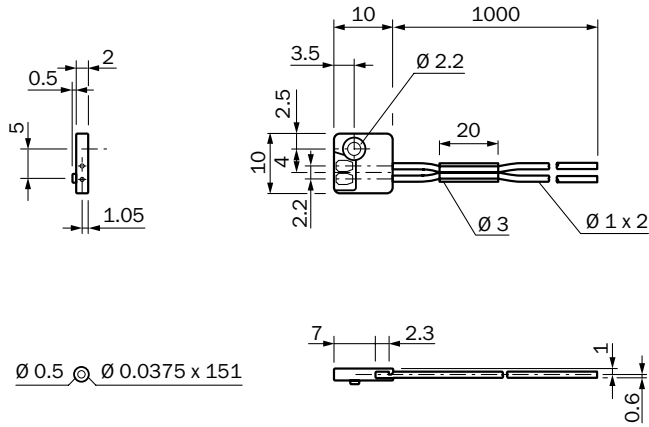
LL3-DC47



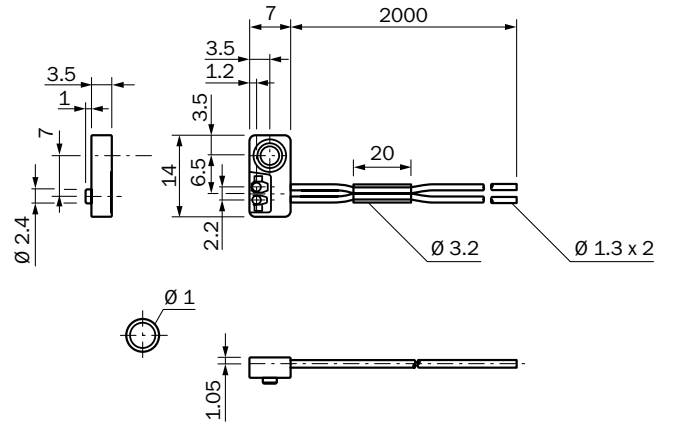
LL3-DE01



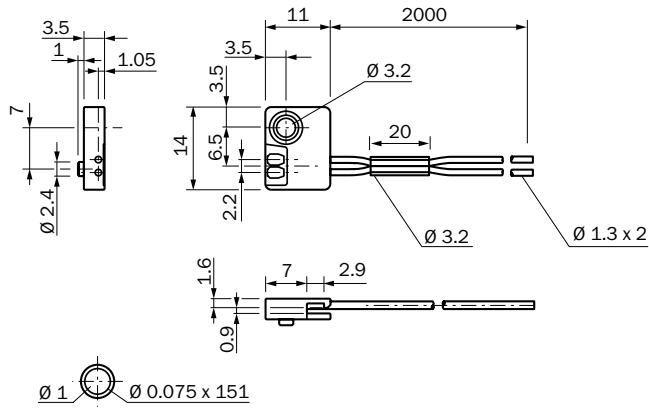
LL3-DE02



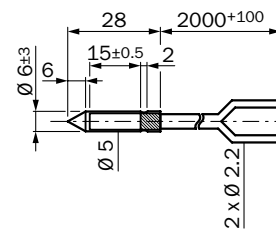
LL3-DE03



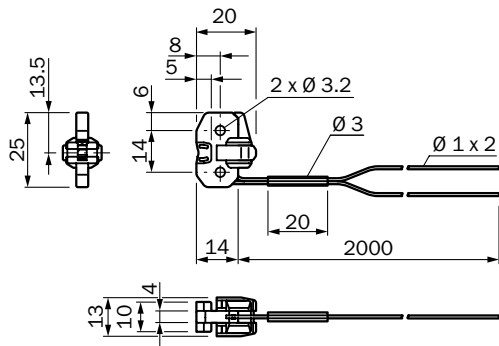
LL3-DE04



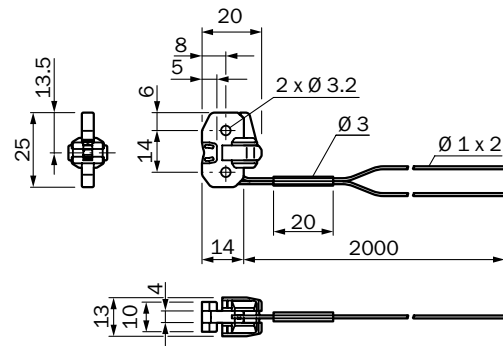
LL3-DF02-S01



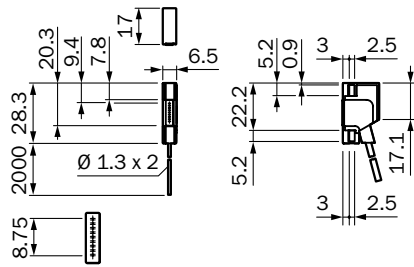
LL3-DF04



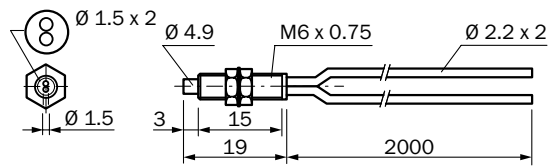
LL3-DF05



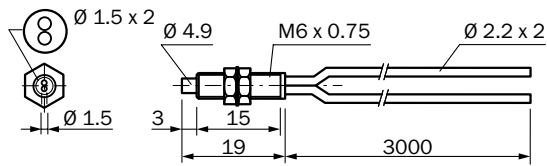
LL3-DF07



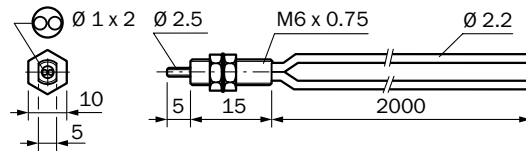
LL3-DH01



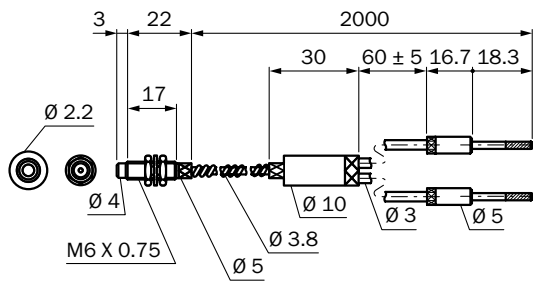
LL3-DH01-03



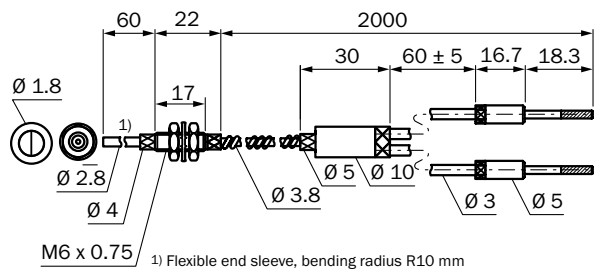
LL3-DH02



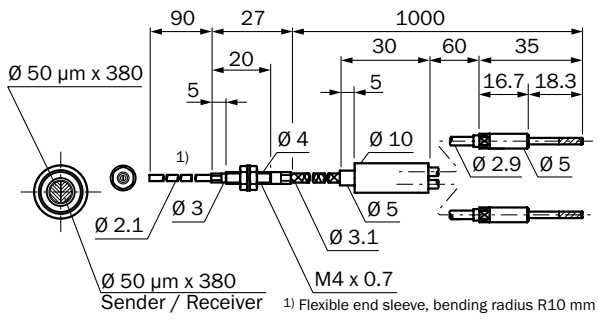
LL3-DH03



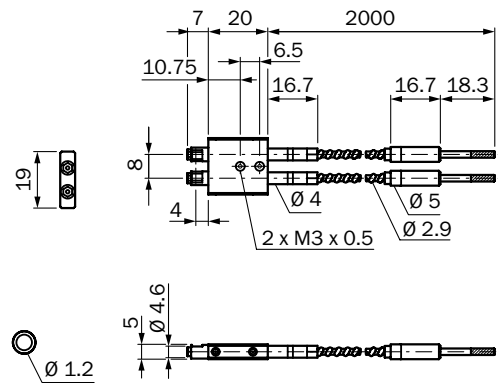
LL3-DH04



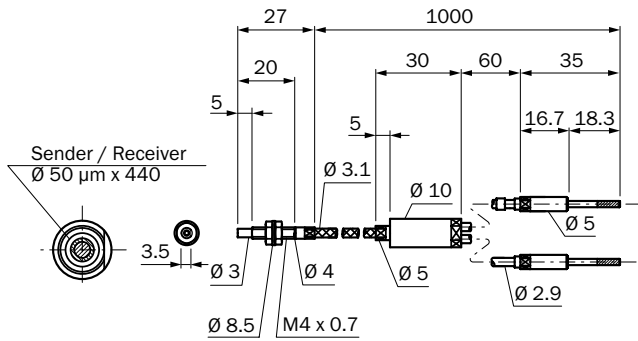
LL3-DH05



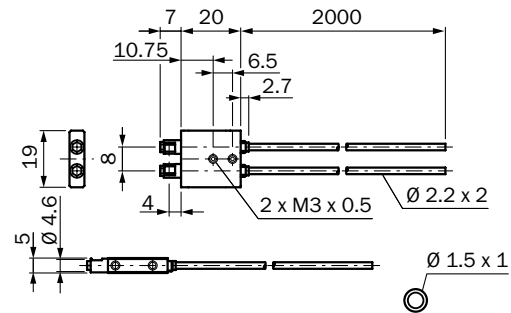
LL3-DH06



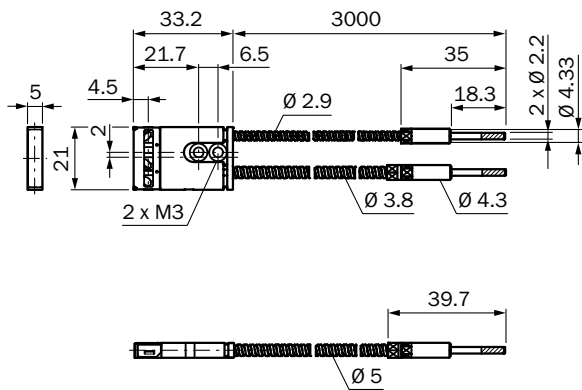
LL3-DH07



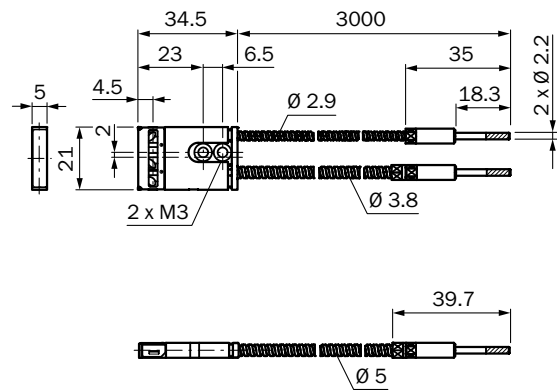
LL3-DH08



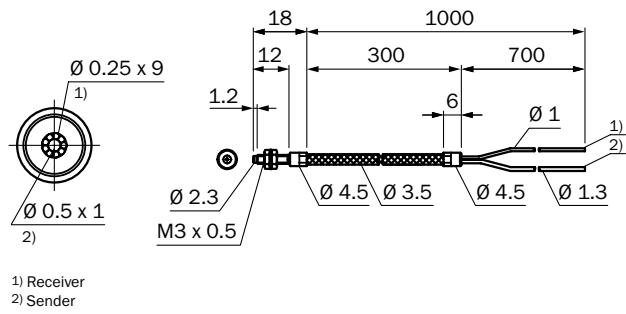
LL3-DH10



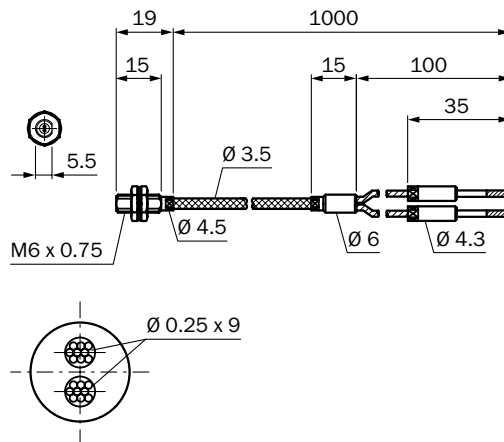
LL3-DH11



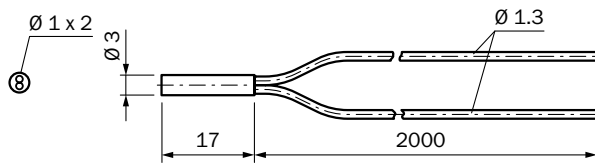
LL3-DJ01



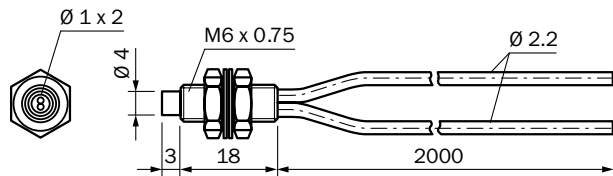
LL3-DJ02



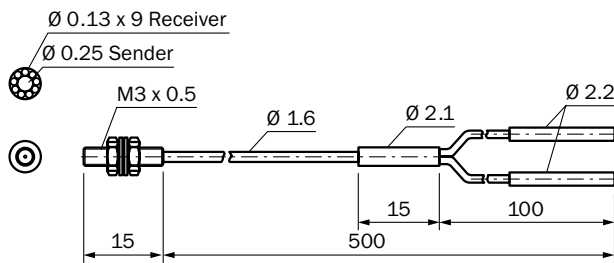
LL3-DK04



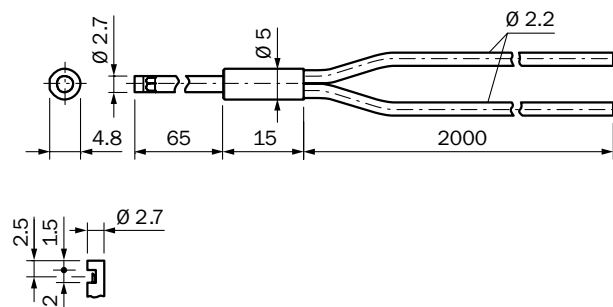
LL3-DK06



LL3-DK21

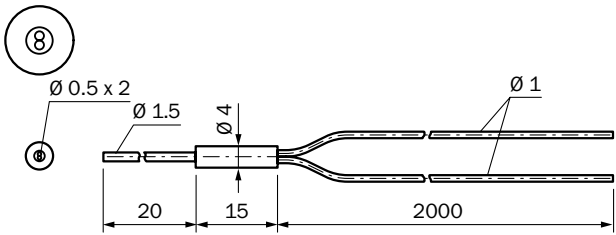


LL3-DK33

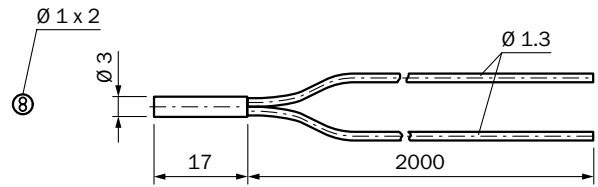




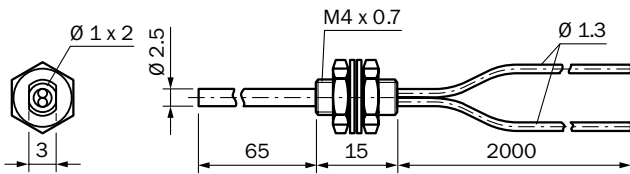
LL3-DK43



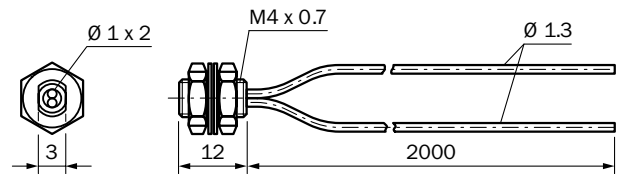
LL3-DK4Z



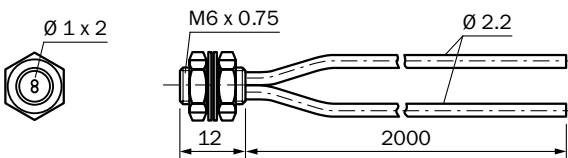
LL3-DK63Z



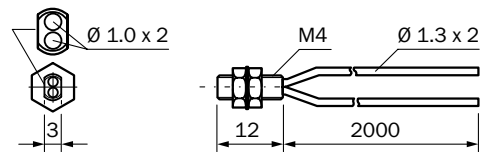
LL3-DK66



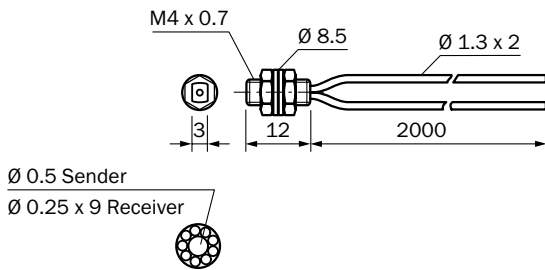
LL3-DK67



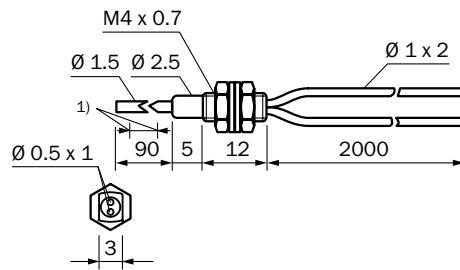
LL3-DM01



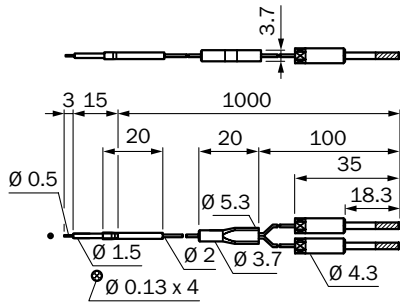
LL3-DM02



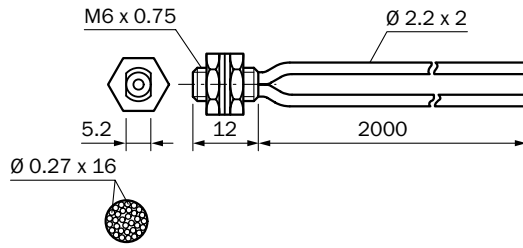
LL3-DM03



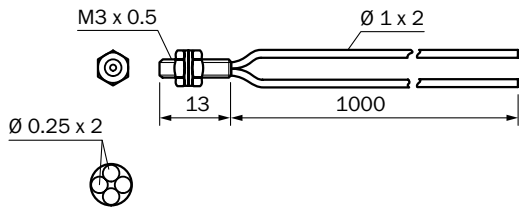
LL3-DP01



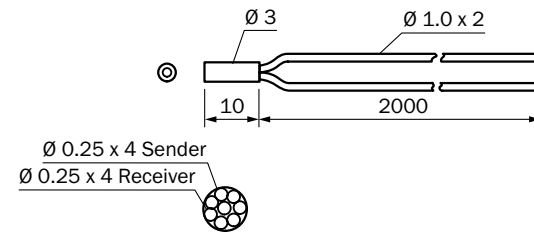
LL3-DR01



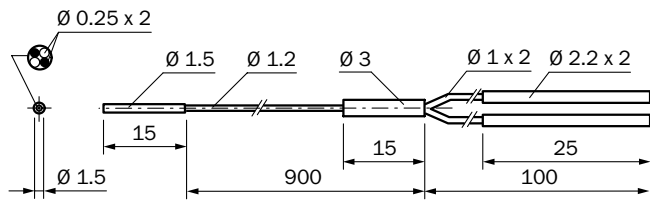
LL3-DR02



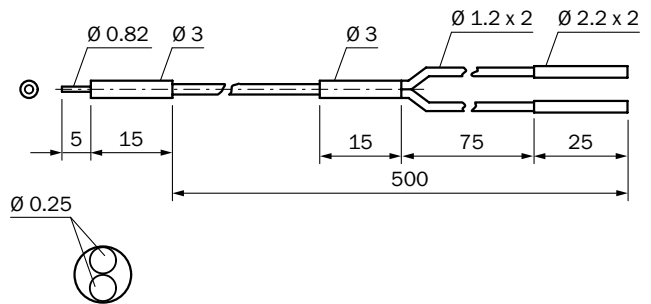
LL3-DR03



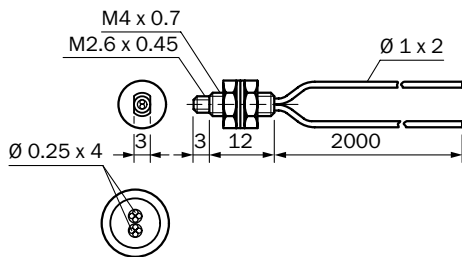
LL3-DR04



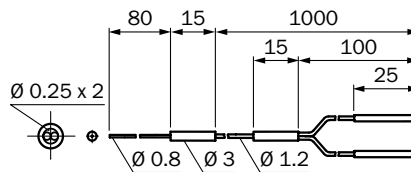
LL3-DR05



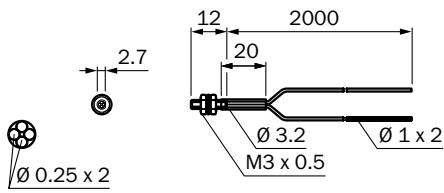
LL3-DR06



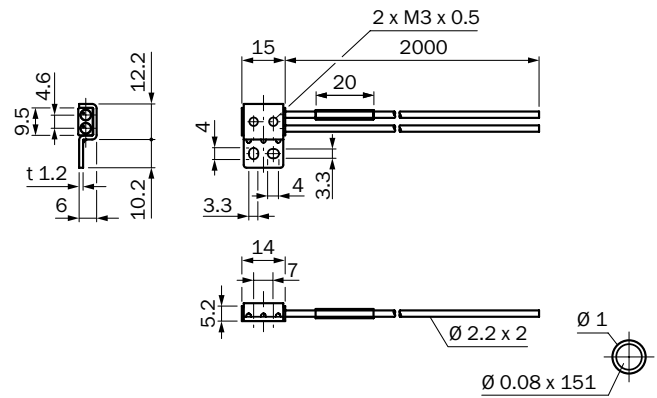
LL3-DR07



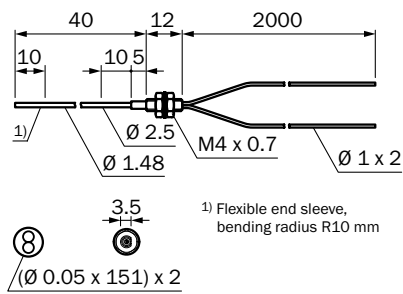
LL3-DR08



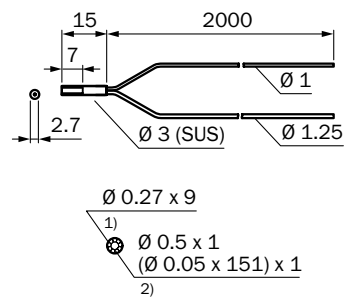
LL3-DR09



LL3-DR10

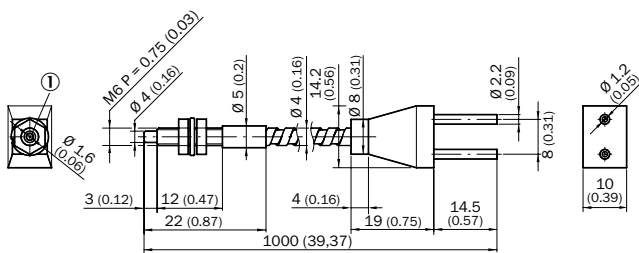


LL3-DR11

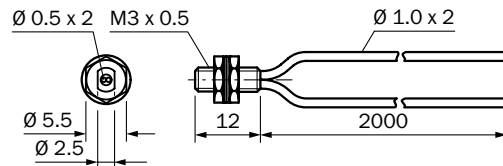


1) Receiver  
2) Sender

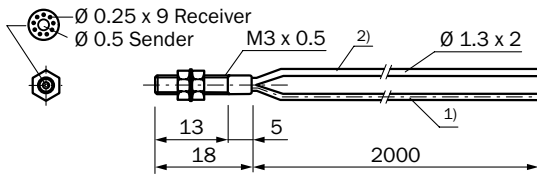
LL3-DR12



LL3-DS06

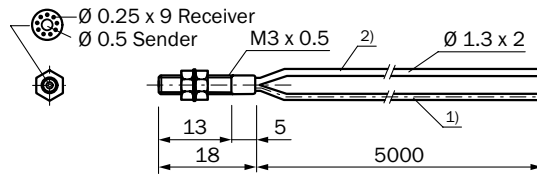


LL3-DT01



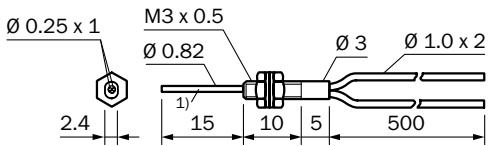
1) Sender  
2) Receiver

LL3-DT01-05



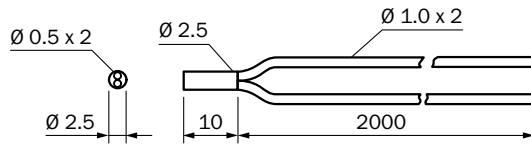
1) Sender  
2) Receiver

LL3-DT02

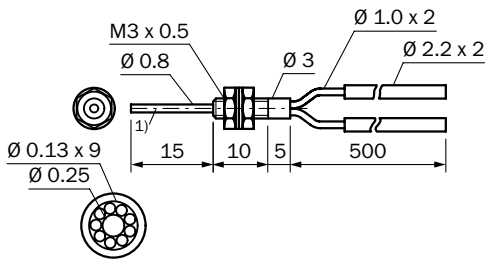


1) End tip cannot be bent

LL3-DT03

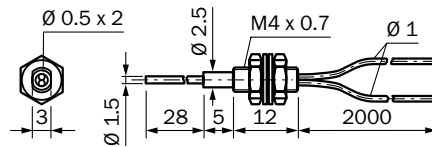


LL3-DT04

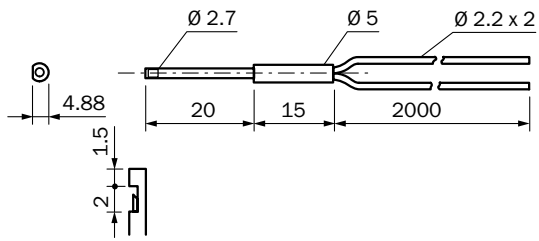


1) End tip cannot be bent

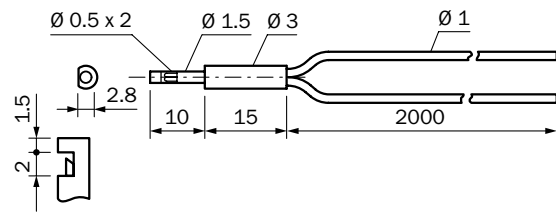
LL3-DT05



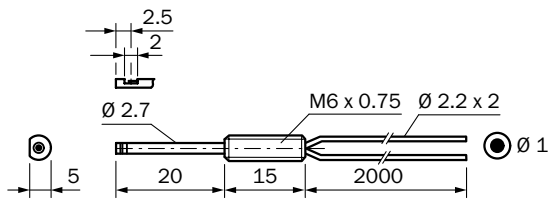
LL3-DV01



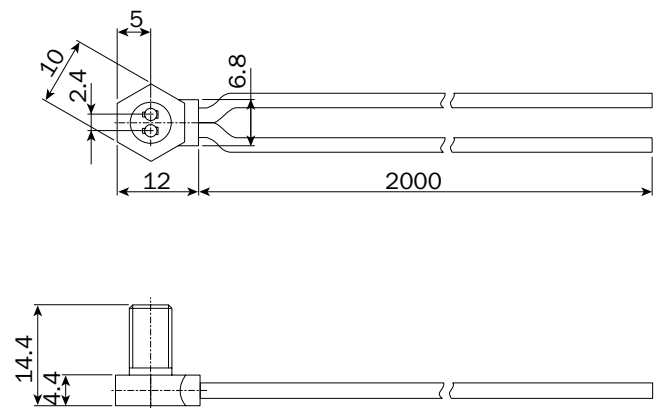
LL3-DV02



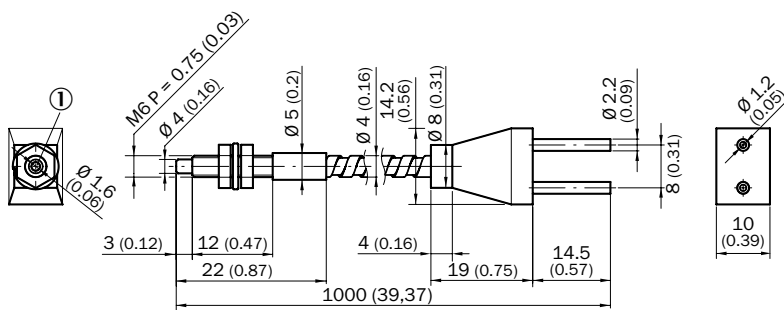
LL3-DV03



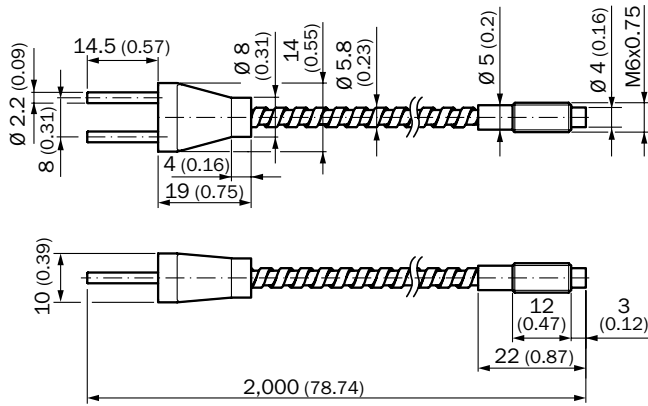
LL3-DV05, LL3-DV06, LL3-DV07



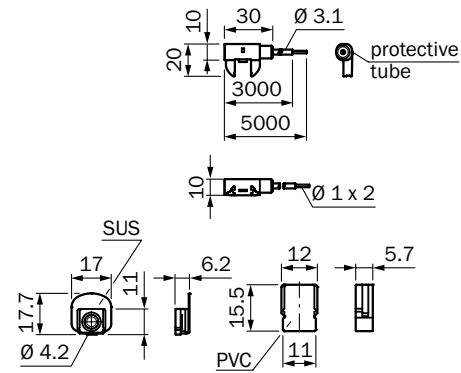
LL3-DW01



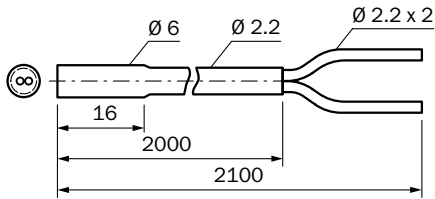
LL3-DW01-2



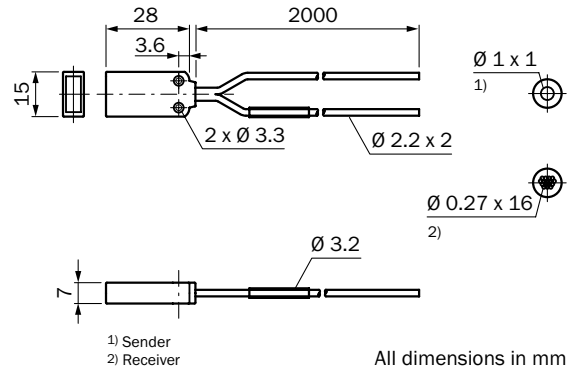
LL3-DW02



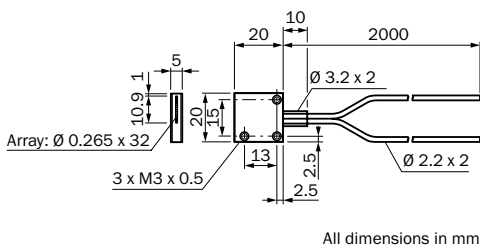
LL3-DY01



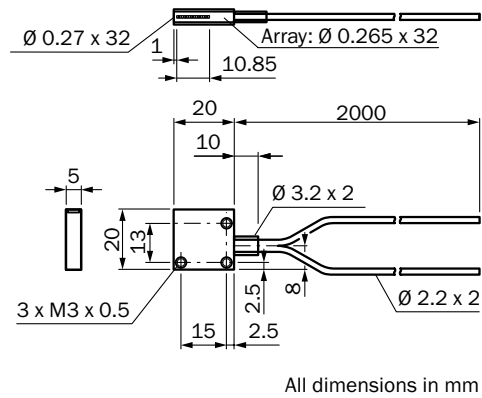
LL3-DZ01



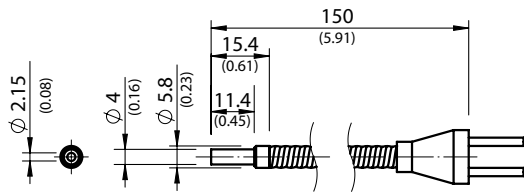
LL3-DZ02



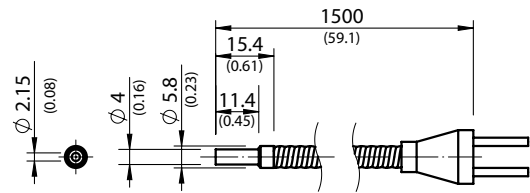
LL3-DZ03



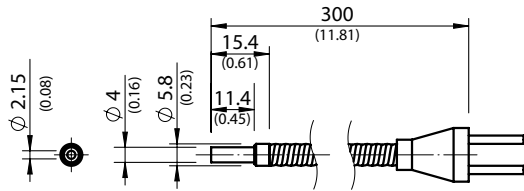
LL3-LM31150



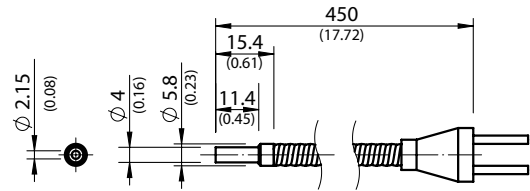
LL3-LM311500



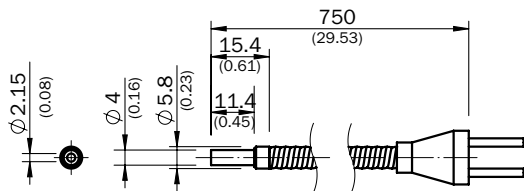
LL3-LM31300



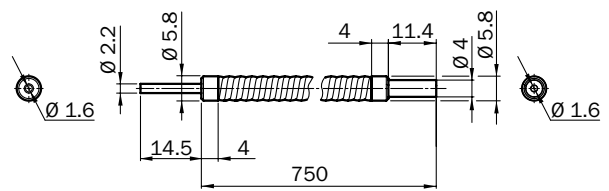
LL3-LM31450



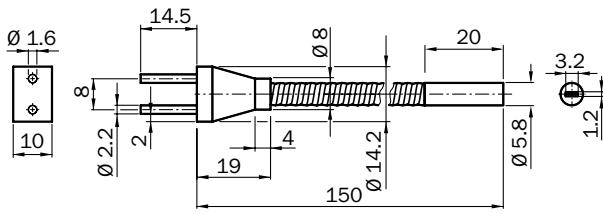
LL3-LM31750



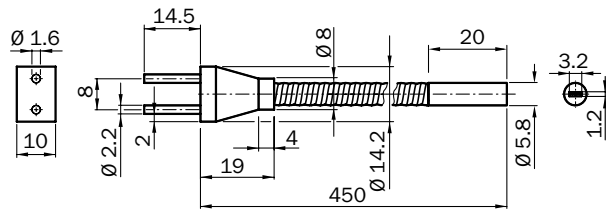
LL3-LM32750



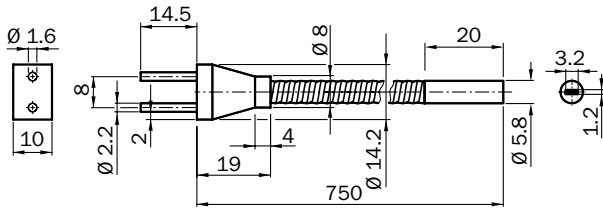
LL3-LM35150



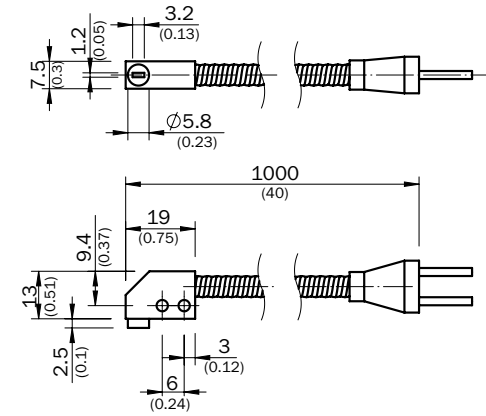
LL3-LM35450



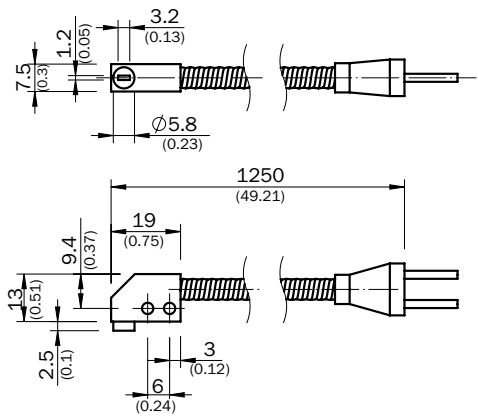
LL3-LM35750



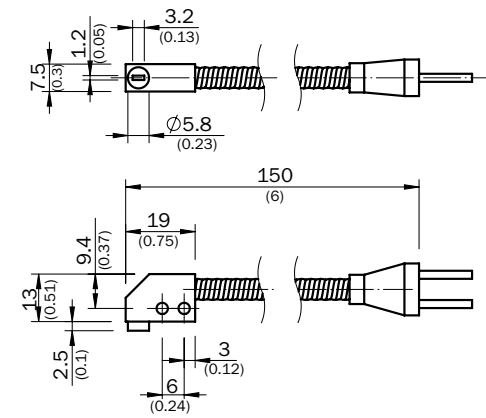
LL3-LM361000



LL3-LM361250

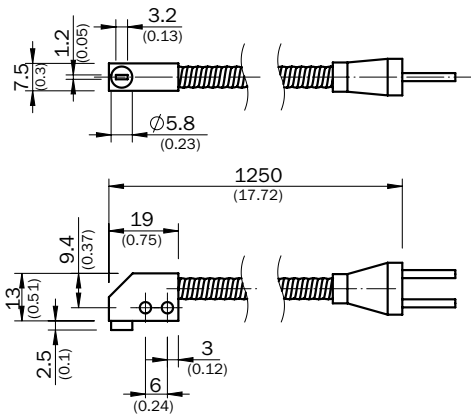


LL3-LM36150

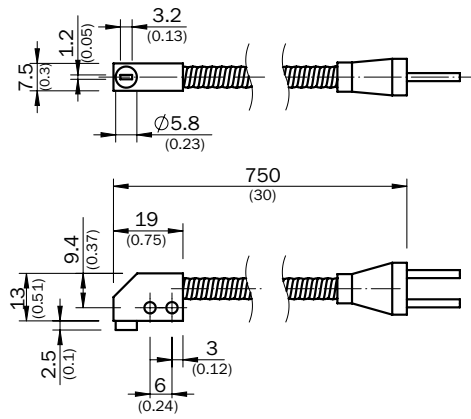




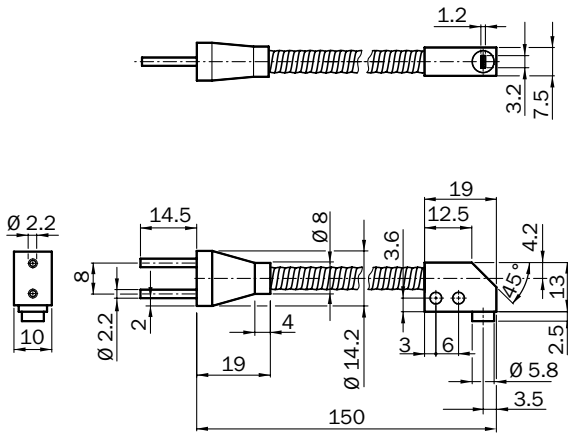
LL3-LM36450



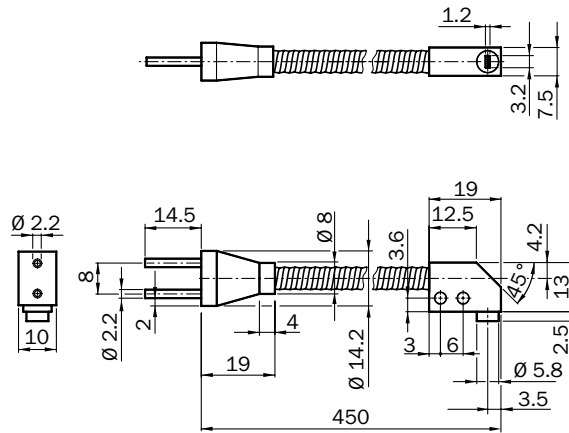
LL3-LM36750



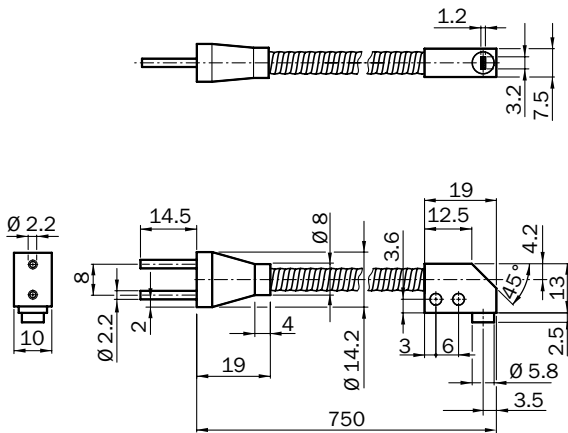
LL3-LM37150



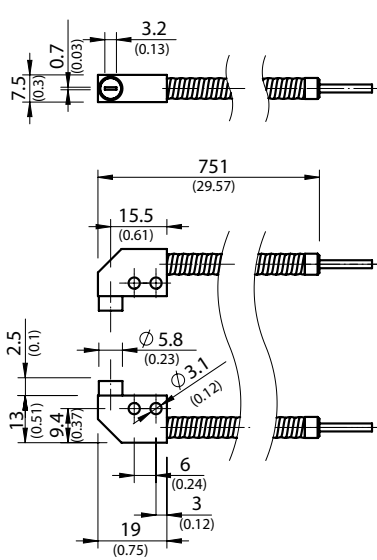
LL3-LM37450



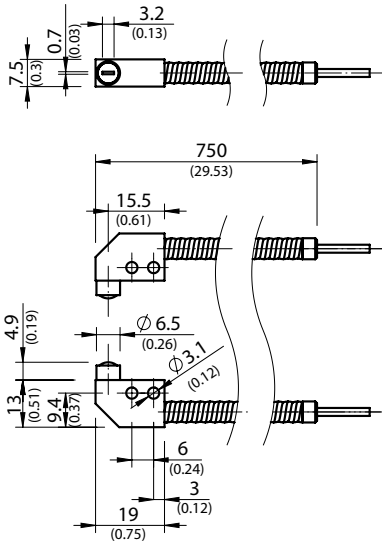
LL3-LM37750



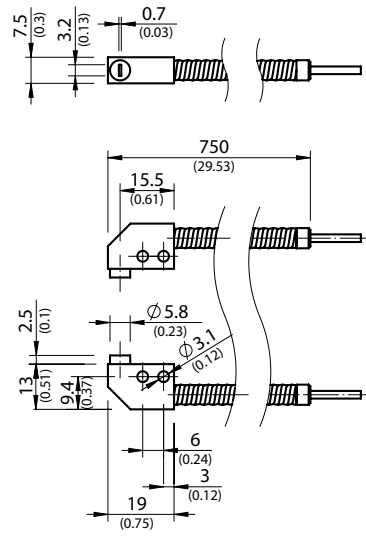
LL3-LM38750



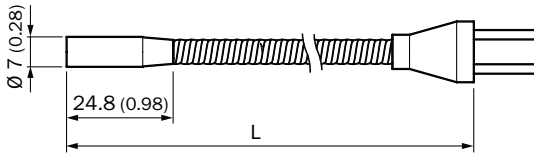
LL3-LM38751



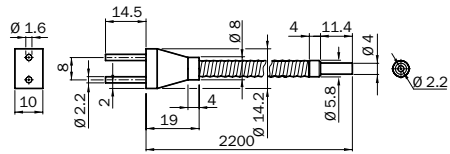
LL3-LM39750



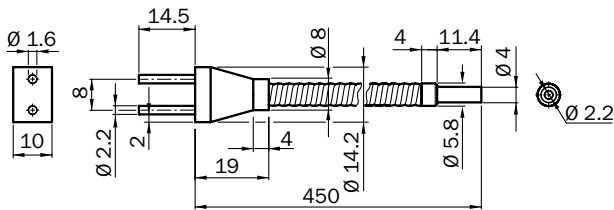
LL3-LM401000



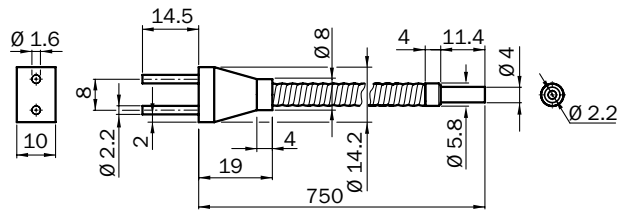
LL3-LT312200



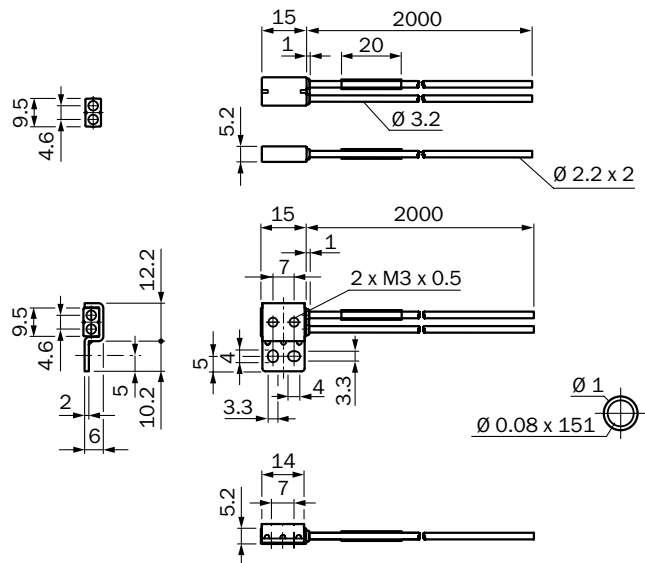
LL3-LT31450



LL3-LT31750



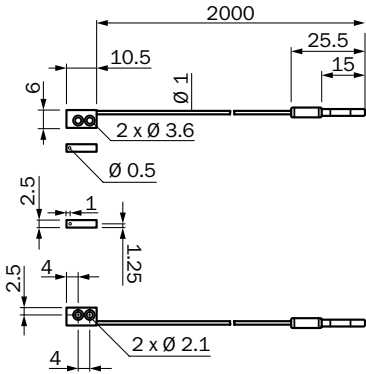
LL3-RR01



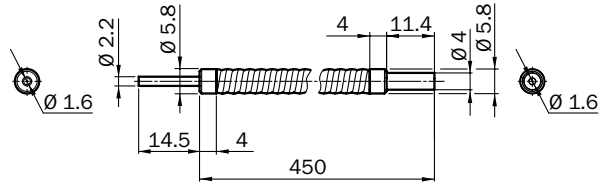


Fiber-optic through-beam systems

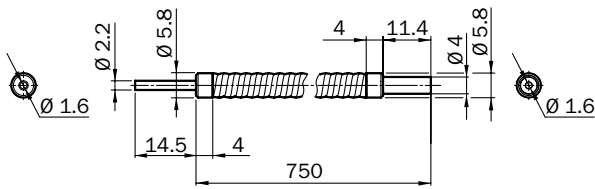
LL3-DC57



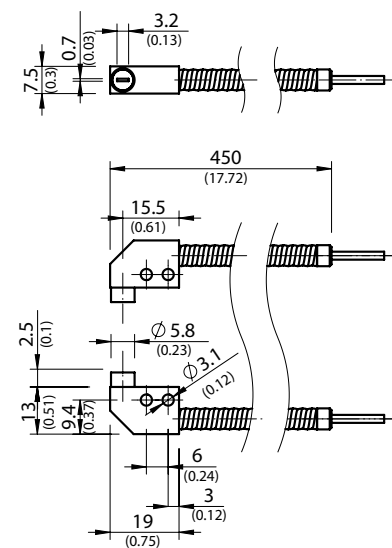
LL3-LM32450



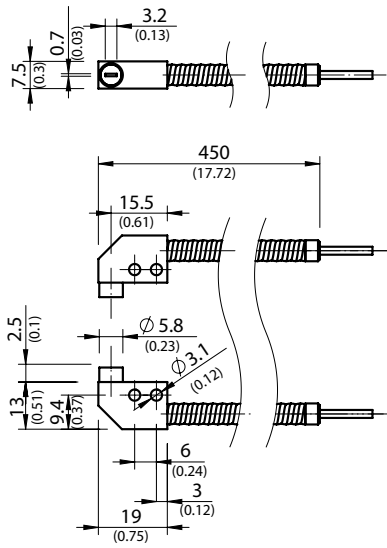
LL3-LM32750



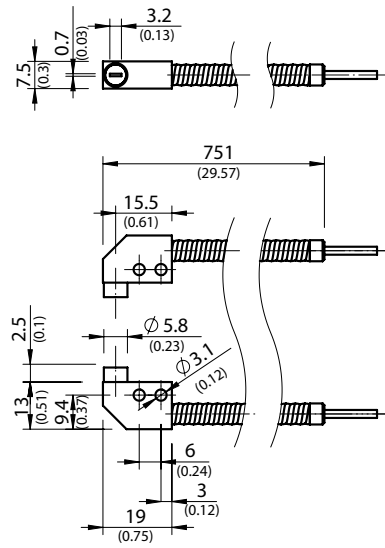
LL3-LM38150



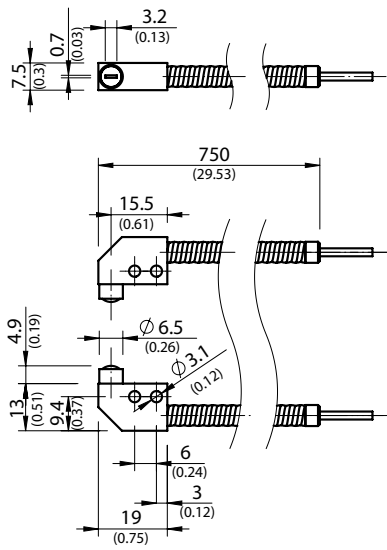
LL3-LM38450



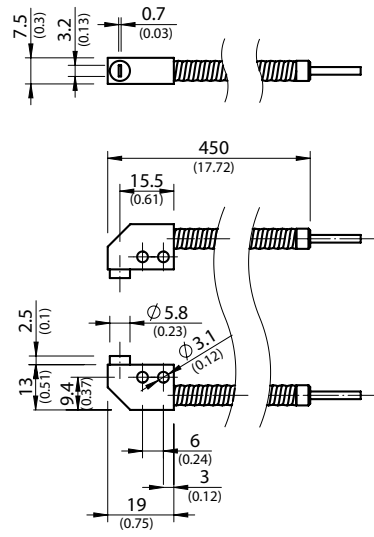
LL3-LM38750



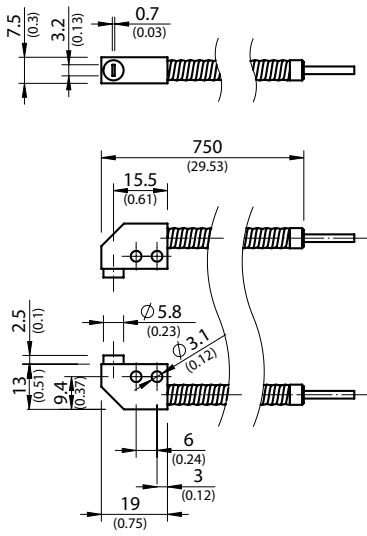
LL3-LM38751



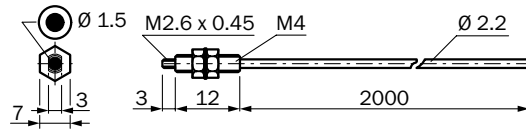
LL3-LM39450



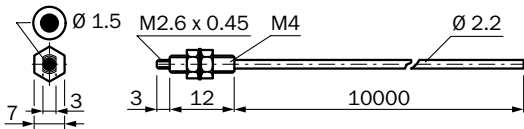
LL3-LM39750



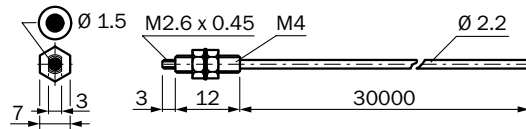
LL3-TB01



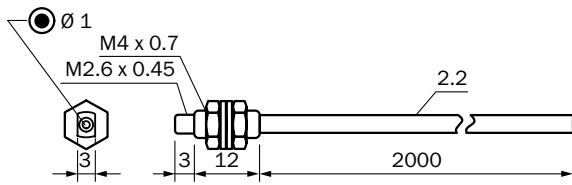
LL3-TB01-10



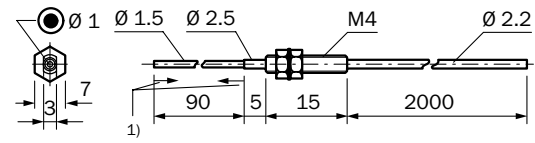
LL3-TB01-30



LL3-TB02

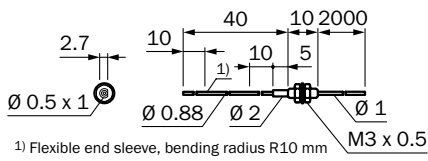


LL3-TB03



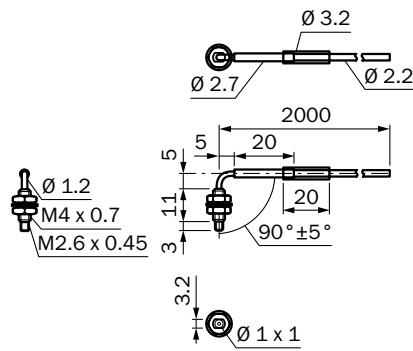
1) Flexible end tip, do not bend in this area (10 mm), bend radius R10 mm

LL3-TB05

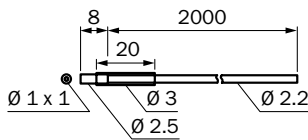


1) Flexible end sleeve, bending radius R10 mm

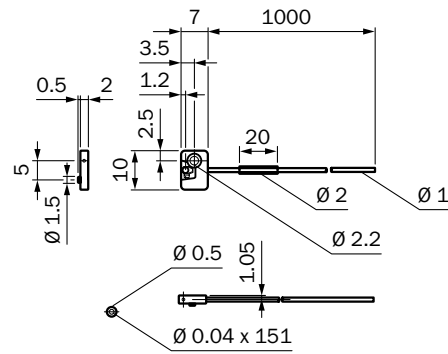
LL3-TB06



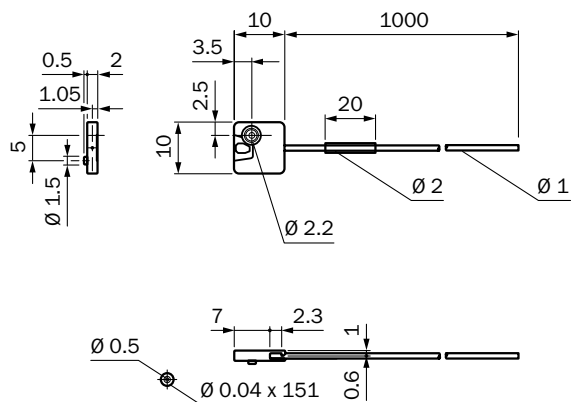
LL3-TB07



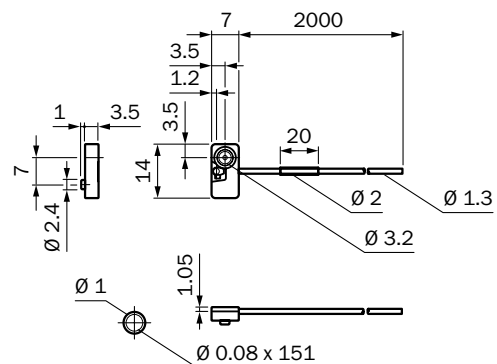
LL3-TE01



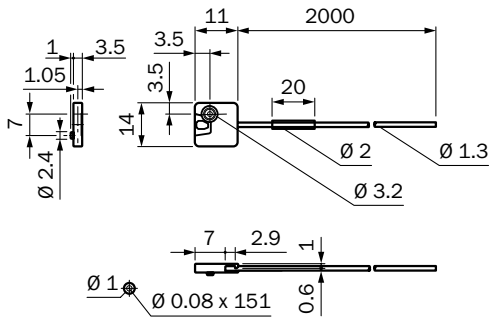
LL3-TE02



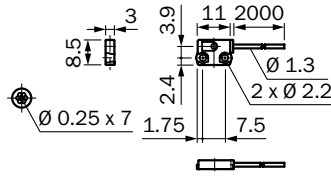
LL3-TE03



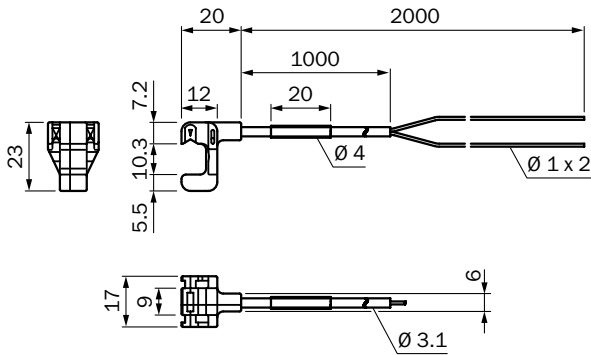
LL3-TE04



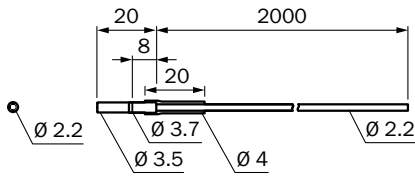
LL3-TE05



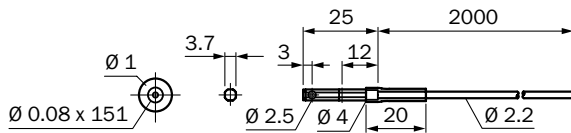
LL3-TF01



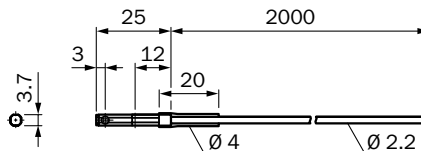
LL3-TG01



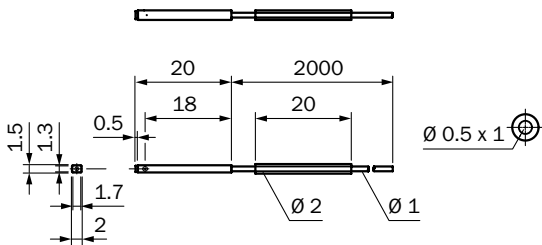
LL3-TG02



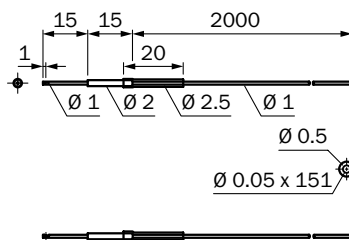
LL3-TG03



LL3-TG04

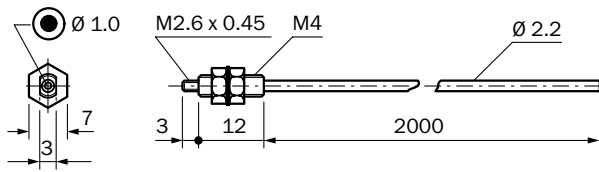


LL3-TG05

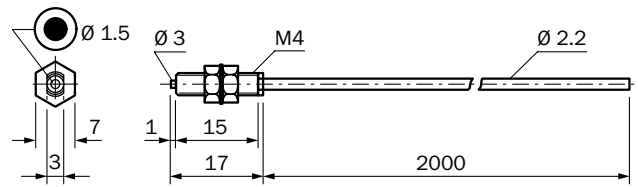




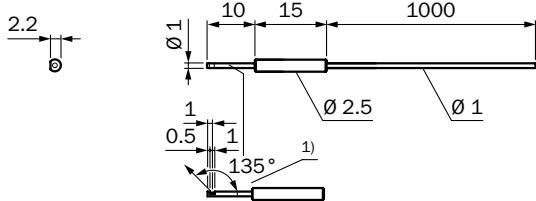
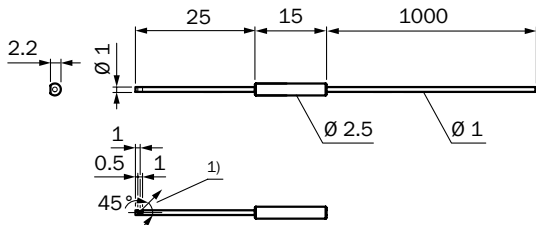
LL3-TH01



LL3-TH02

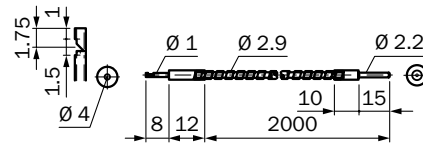


LL3-TH06

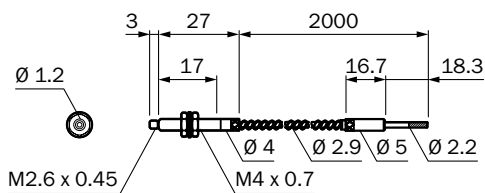


1) angle of beam

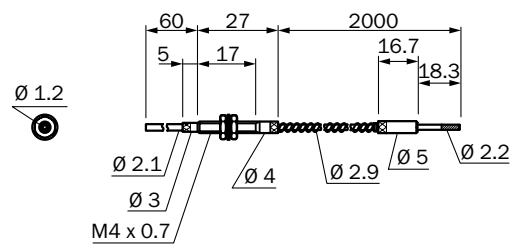
LL3-TH07



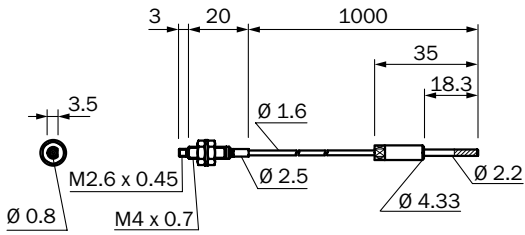
LL3-TH08



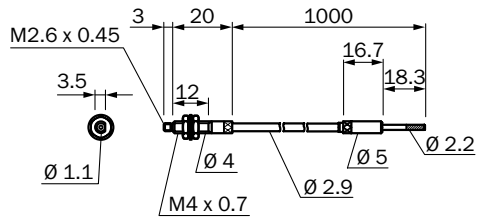
LL3-TH09



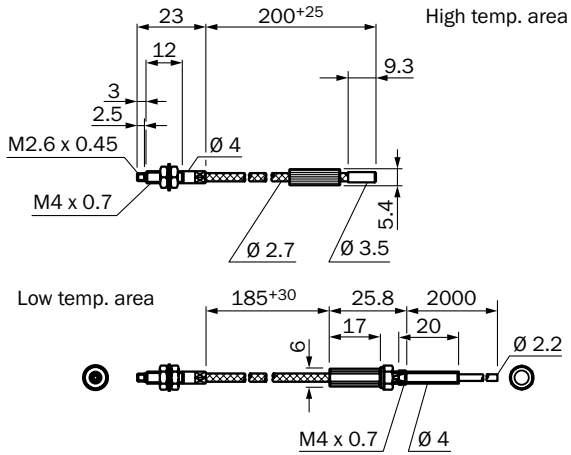
LL3-TH10



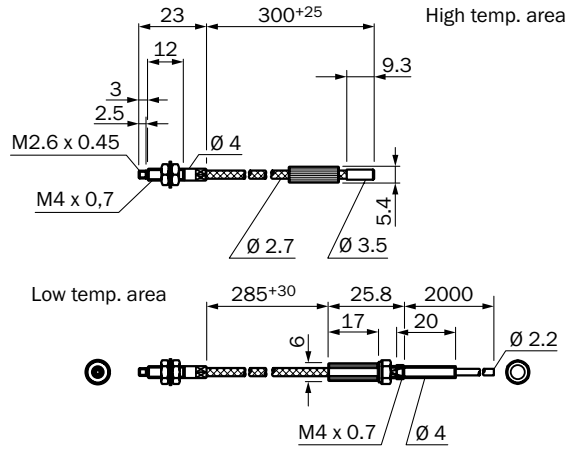
LL3-TH11



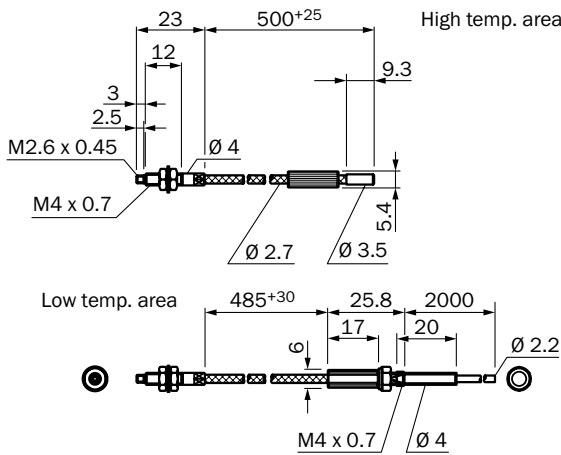
LL3-TH12



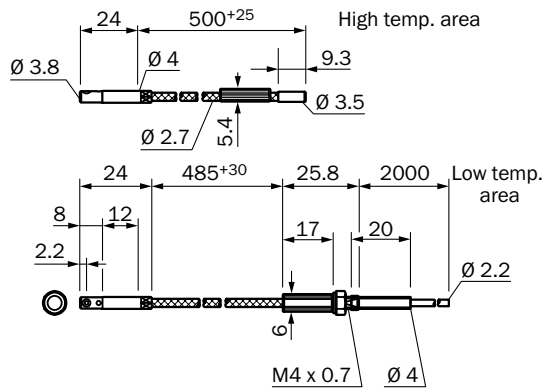
LL3-TH13



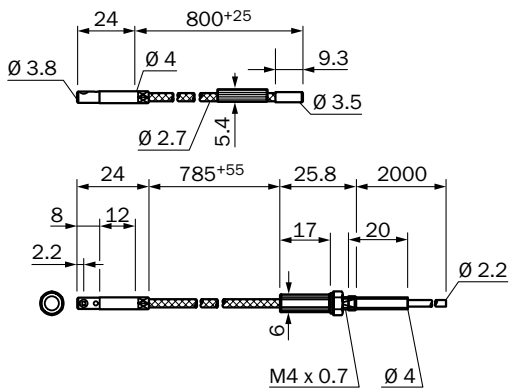
LL3-TH14



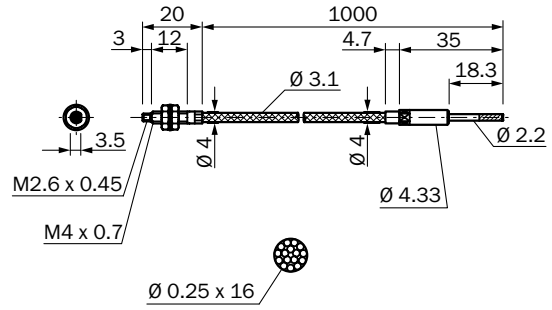
LL3-TH15



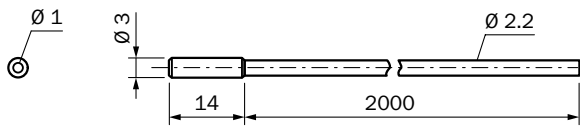
LL3-TH16



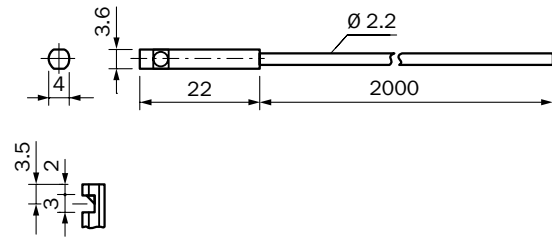
LL3-TJ01



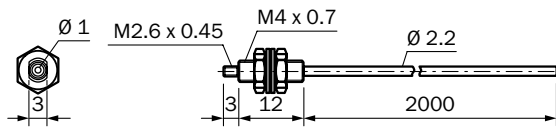
LL3-TK05



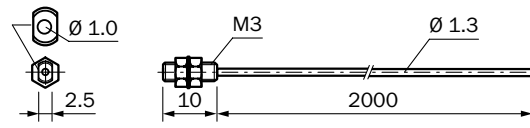
LL3-TK16



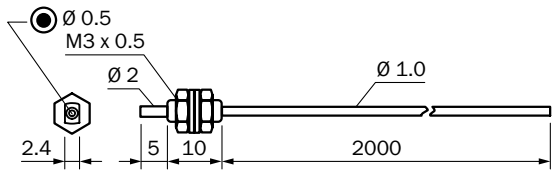
LL3-TK77



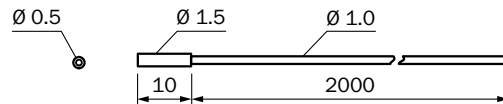
LL3-TM01



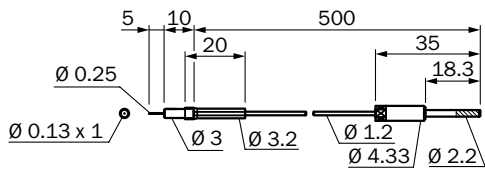
LL3-TM02



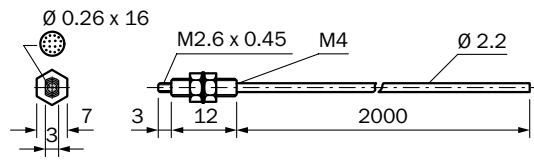
LL3-TM03



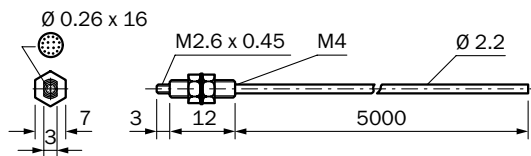
LL3-TP01



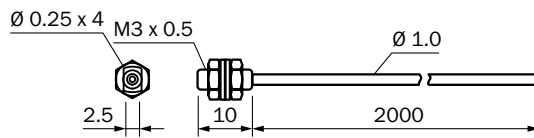
LL3-TR01



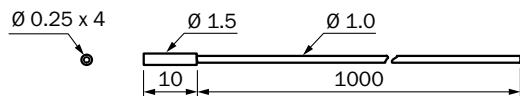
LL3-TR01-05



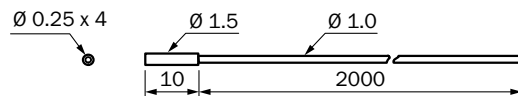
LL3-TR02



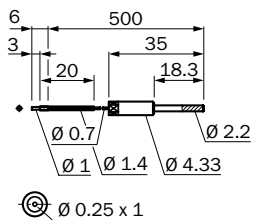
LL3-TR03



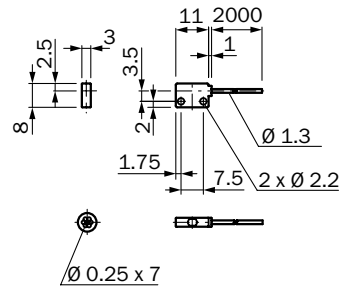
LL3-TR03-2



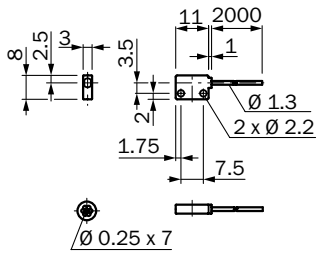
LL3-TR04



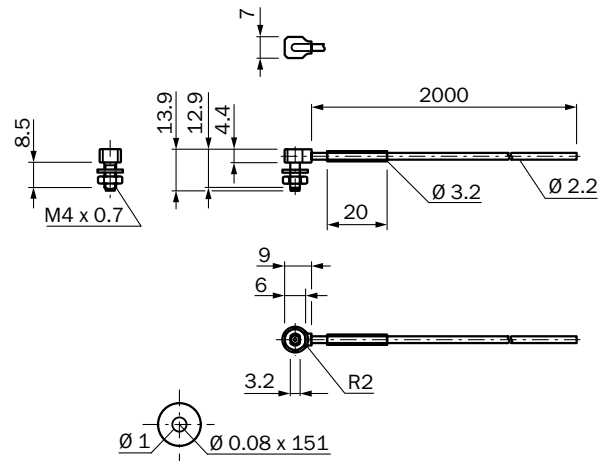
LL3-TR05



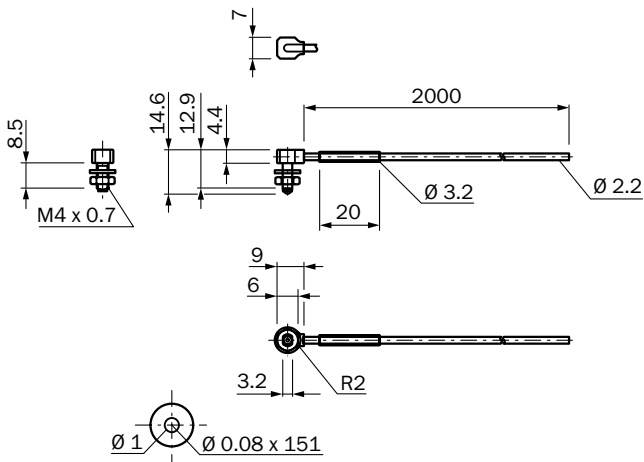
LL3-TR06



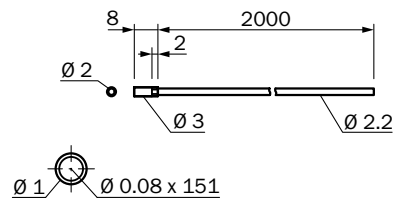
LL3-TR08



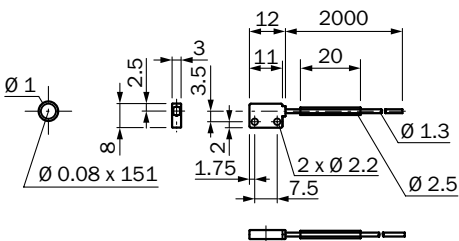
LL3-TR09



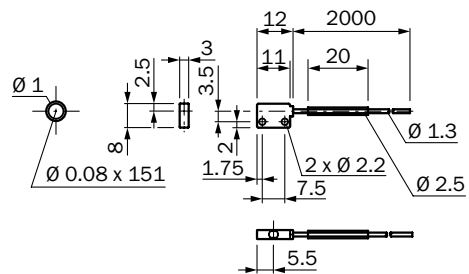
LL3-TR10



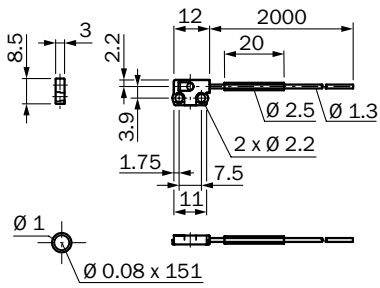
LL3-TR11



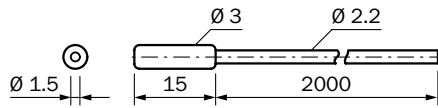
LL3-TR12



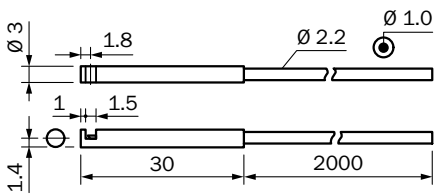
LL3-TR13



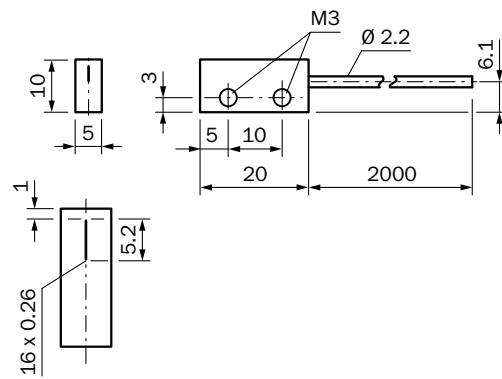
LL3-TS07



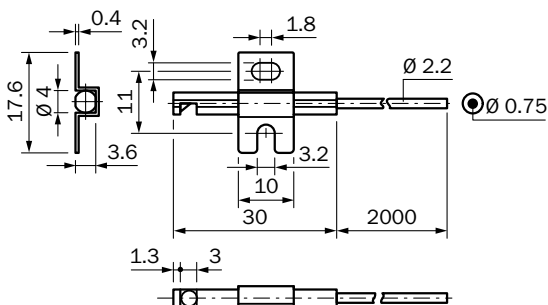
LL3-TS08



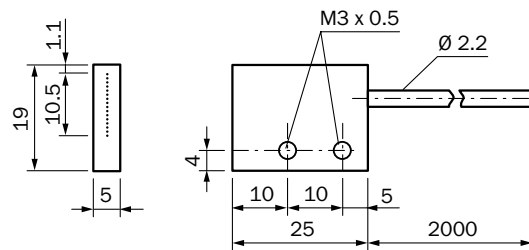
LL3-TS10



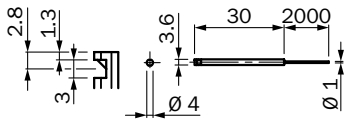
LL3-TS12



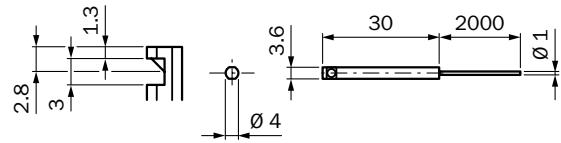
LL3-TS14



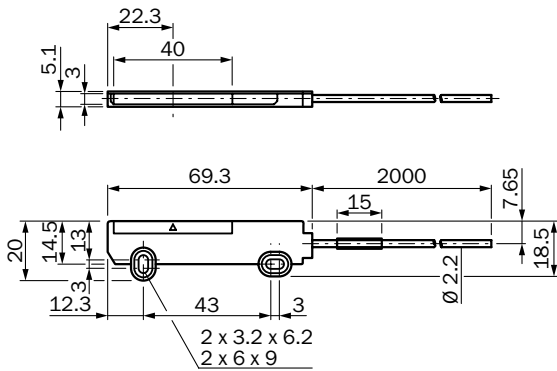
LL3-TS22



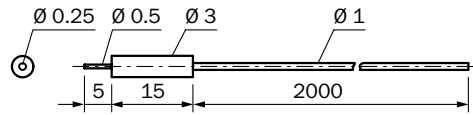
LL3-TS22M



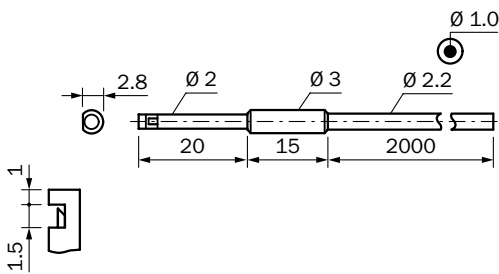
LL3-TS40



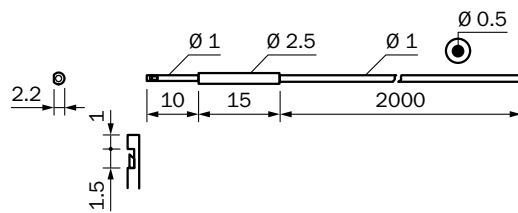
LL3-TT01



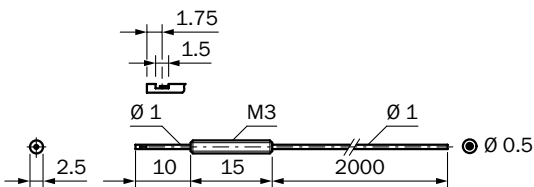
LL3-TV01



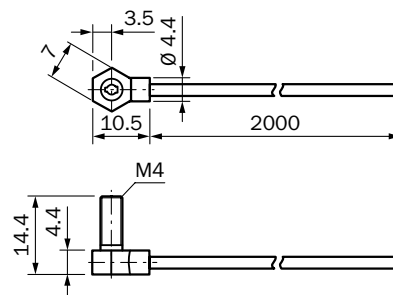
LL3-TV02



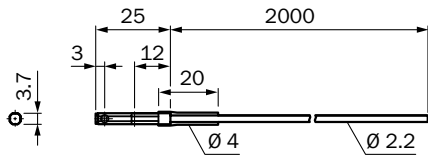
LL3-TV04



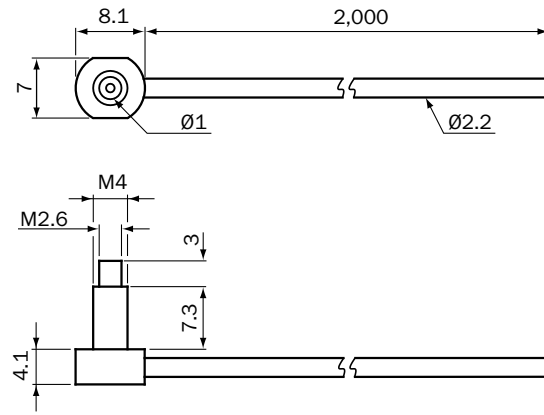
LL3-TV05, LL3-TV06, LL3-TV07



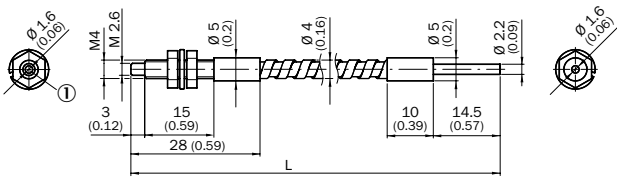
LL3-TV08



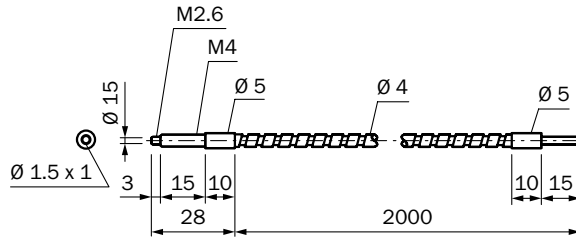
LL3-TV77



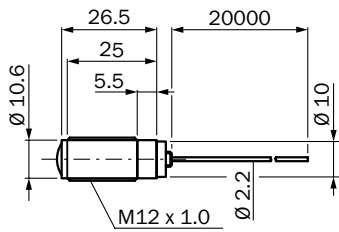
LL3-TW01



LL3-TW01-2

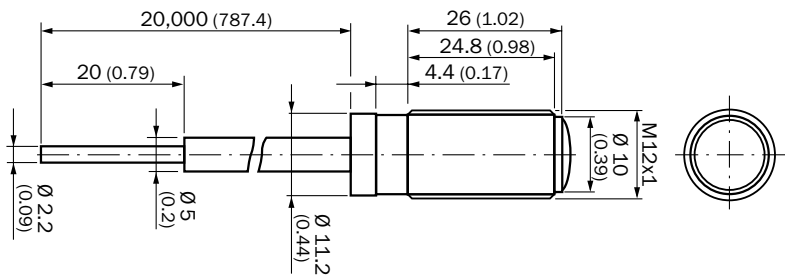


LL3-TX01



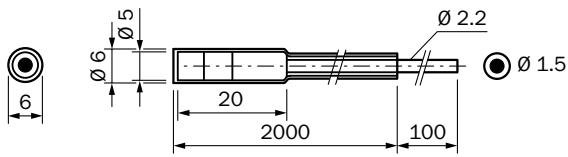
All dimensions in mm

LL3-TX02

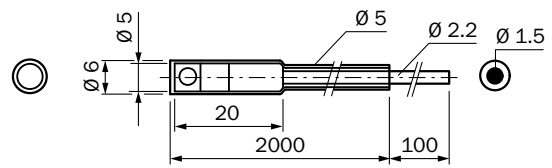




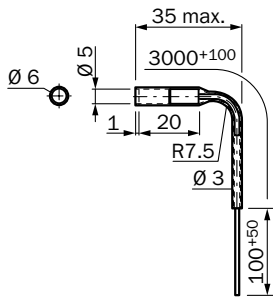
LL3-TY01



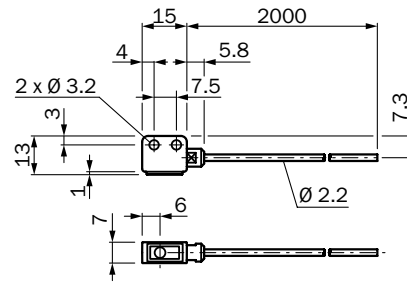
LL3-TY02



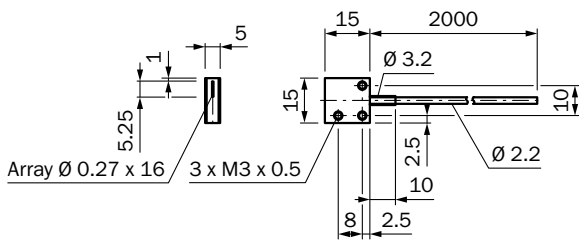
LL3-TY03



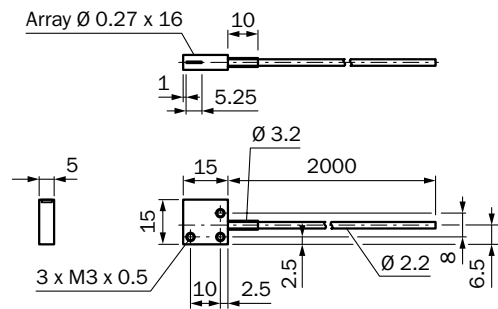
LL3-TY05



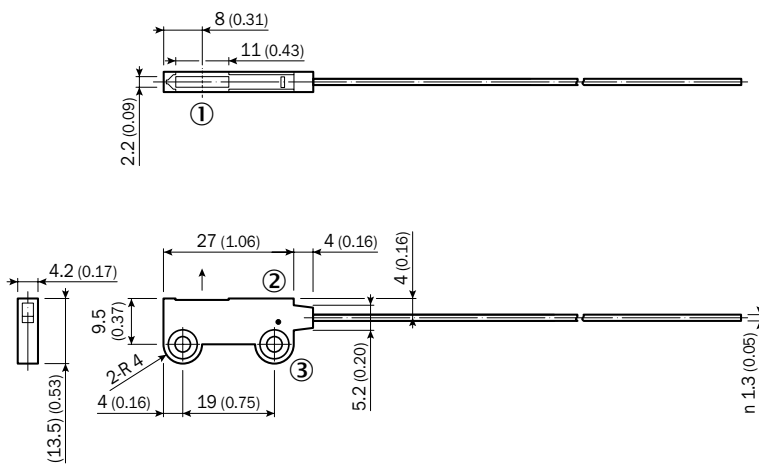
LL3-TZ05



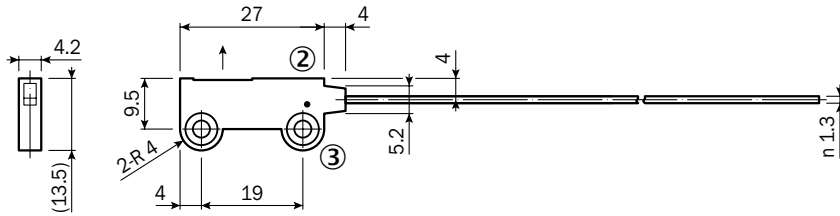
LL3-TZ06



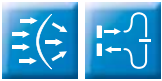
LL3-TZ09



LL3-TZ10



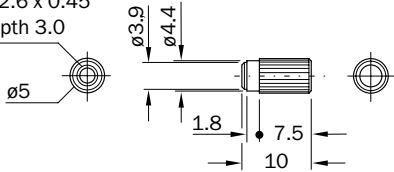
Dimensional drawings (dimensions in mm)



Tip adapters, through-beam system

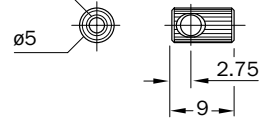
LL3-TA01, LL3-TA01S

M 2.6 x 0.45  
Depth 3.0



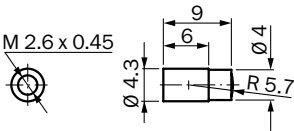
LL3-TA02

M 2.6 x 0.45  
Depth 3.0

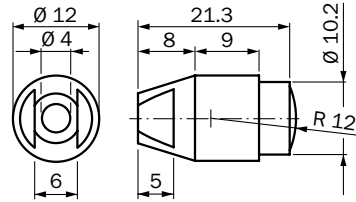


LL3-TA03

M 2.6 x 0.45

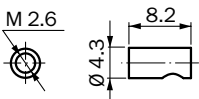


LL3-TA04



LL3-TA05

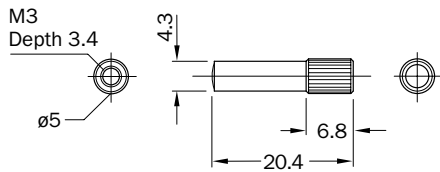
M 2.6



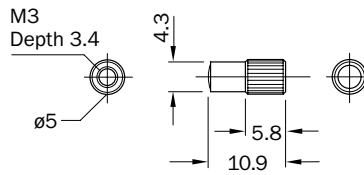


Tip adapters, proximity system

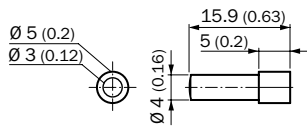
LL3-DA01



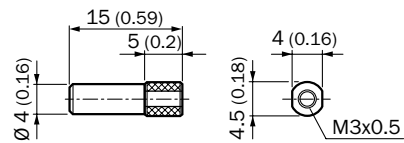
LL3-DA02



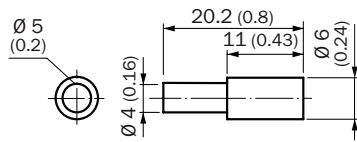
LL3-DA03



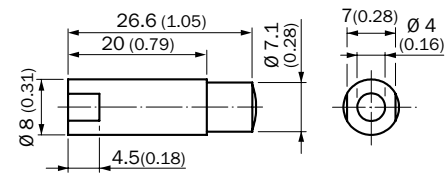
LL3-DA04



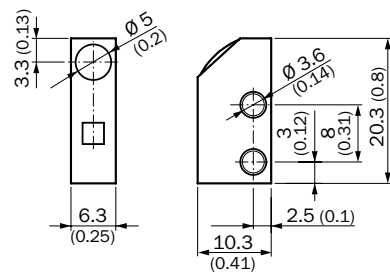
LL3-DA05



LL3-DA06



LL3-DA07



Type	Part no.	Page
BEF-LL3M61000	5331291	→ E-106
BEF-LL3M6500	5331290	→ E-106
BEF-WLL180	5325812	→ E-106
BF-EB01-W190	5313011	→ E-106
BF-WLL160-10	5305479	→ E-106
BF-WLL160-13	5306094	→ E-106
BL-TS40-30	5324719	→ E-107
BL-TS40-40	5334439	→ E-107
DOL-0803-G02MRN	6058504	→ E-108
DOL-0803-G05MRN	6058505	→ E-108
DOL-0803-G10MRN	6058506	→ E-108
DOL-0803-W02MRN	6058507	→ E-108
DOL-0803-W05MRN	6058508	→ E-108
DOL-0803-W10MRN	6058509	→ E-108
DOL-0804-G02MRN	6058510	→ E-109
DOL-0804-G05MRN	6058511	→ E-109
DOL-0804-G10MRN	6058512	→ E-109
DOL-0804-G25MRN	6058513	→ E-109
DOL-0804-W02MRN	6058514	→ E-109
DOL-0804-W05MRN	6058515	→ E-109
DOL-0804-W10MRN	6058517	→ E-109
DOL-0804-W25MRN	6058518	→ E-109
DOS-0803-G	7902077	→ E-111
DOS-0803-W	7902078	→ E-111
DOS-0804-G	6009974	→ E-112
DOS-0804-W	6009975	→ E-112
FC	5304141	→ E-106
GLL170-N332	6063337	→ D-94
GLL170-N333	6063339	→ D-94
GLL170-N334	6063338	→ D-94
GLL170-P332	6063334	→ D-94
GLL170-P333	6063336	→ D-94
GLL170-P334	6063335	→ D-94
GLL170T-B333	6063342	→ D-94
GLL170T-B432	6063340	→ D-94
GLL170T-B434	6063341	→ D-94
LL3-DA01	5308127	→ C-80
LL3-DA02	5308130	→ C-80
LL3-DA03	5326465	→ C-80
LL3-DA04	5326466	→ C-80
LL3-DA05	5326467	→ C-80
LL3-DA06	5326468	→ C-80
LL3-DA07	5326469	→ C-80
LL3-DB01	5308074	→ B-18
LL3-DB01-10	5308075	→ B-18
LL3-DB01-3	5322552	→ B-19
LL3-DB01-30	5324662	→ B-19
LL3-DB02	5308083	→ B-45
LL3-DB03	5313021	→ B-19
LL3-DB04	5325990	→ B-19
LL3-DB05	5326002	→ B-45
LL3-DB06	5326006	→ B-46
LL3-DB07	5325988	→ B-19
LL3-DB08	5326004	→ B-46
LL3-DB09	5325991	→ B-32
LL3-DB10	5325999	→ B-26

Type	Part no.	Page
LL3-DC03	5326020	→ B-39, B-64
LL3-DC04	5326018	→ B-39, B-65, B-68, B-72
LL3-DC05	5326016	→ B-40, B-65
LL3-DC06	5326017	→ B-40, B-65, B-68, B-72
LL3-DC07	5326019	→ B-40, B-65
LL3-DC08	5326029	→ B-40, B-65
LL3-DC09	5326028	→ B-40, B-65
LL3-DC38	5322472	→ B-40, B-65
LL3-DC39	5322513	→ B-40, B-65
LL3-DC47	5324268	→ B-40, B-73
LL3-DC57	5324269	→ B-43, B-76
LL3-DE01	5325285	→ B-41, B-73
LL3-DE02	5324497	→ B-41, B-73
LL3-DE03	5325986	→ B-41, B-73
LL3-DE04	5325987	→ B-41, B-73
LL3-DF02-S01	5321924	→ B-60
LL3-DF04	5326035	→ B-61
LL3-DF05	5326034	→ B-61
LL3-DF07	5326033	→ B-61
LL3-DH01	5308091	→ B-19, B-53
LL3-DH01-03	5321260	→ B-19, B-53
LL3-DH02	5308092	→ B-19, B-54
LL3-DH03	5324787	→ B-54
LL3-DH04	5326022	→ B-46, B-54
LL3-DH05	5326021	→ B-46, B-54
LL3-DH06	5326026	→ B-41, B-54, B-65
LL3-DH07	5326031	→ B-54
LL3-DH08	5326025	→ B-41, B-54, B-66
LL3-DH10	5326023	→ B-41, B-54, B-66
LL3-DH11	5326024	→ B-41, B-54, B-66
LL3-DJ01	5325989	→ B-19
LL3-DJ02	5325992	→ B-20
LL3-DK04	5313020	→ B-26
LL3-DK06	5313019	→ B-20
LL3-DK21	5313023	→ B-20
LL3-DK33	5313031	→ B-32, B-46
LL3-DK43	5313030	→ B-46
LL3-DK4Z	5313026	→ B-26, B-73
LL3-DK63Z	5313027	→ B-46, B-73
LL3-DK66	5313024	→ B-20, B-73
LL3-DK67	5313025	→ B-20, B-73
LL3-DM01	5308071	→ B-20
LL3-DM02	5308077	→ B-20
LL3-DM03	5308084	→ B-46
LL3-DP01	5325998	→ B-27
LL3-DR01	5308078	→ B-20, B-69, B-74
LL3-DR02	5308079	→ B-20, B-69, B-74
LL3-DR03	5308080	→ B-27, B-69, B-74
LL3-DR04	5308081	→ B-27, B-69, B-74
LL3-DR05	5308087	→ B-27, B-46, B-69
LL3-DR06	5308082	→ B-21, B-69, B-74
LL3-DR07	5326007	→ B-47
LL3-DR08	5326037	→ B-21, B-69
LL3-DR09	5325528	→ B-41, B-66, B-74
LL3-DR10	5326005	→ B-47
LL3-DR11	5326000	→ B-27

Type	Part no.	Page
LL3-DR12	5326001	→ B-27, B-33, B-74
LL3-DS06	5308073	→ B-21
LL3-DT01	5308076	→ B-21
LL3-DT01-05	5309087	→ B-21
LL3-DT02	5308085	→ B-47, B-70, B-74
LL3-DT03	5308072	→ B-27
LL3-DT04	5308086	→ B-47, B-70, B-75
LL3-DT05	5313028	→ B-47
LL3-DV01	5308088	→ B-33, B-47
LL3-DV02	5308089	→ B-33, B-47
LL3-DV03	5308090	→ B-33, B-47
LL3-DV05	5322549	→ B-21, B-33
LL3-DV06	5322550	→ B-21, B-33, B-55
LL3-DV07	5322551	→ B-21, B-33, B-75
LL3-DW01	5315234	→ B-21, B-55, B-61
LL3-DW01-2	5324789	→ B-22, B-55, B-61
LL3-DW02	5325608	→ B-61
LL3-DY01	5308093	→ B-58
LL3-DZ01	5326013	→ B-50
LL3-DZ02	5326014	→ B-51
LL3-DZ03	5326015	→ B-51
LL3-LM31150	2073483	→ B-27
LL3-LM311500	2073486	→ B-28
LL3-LM31300	2079212	→ B-27
LL3-LM31450	2073484	→ B-28
LL3-LM31750	2073485	→ B-28
LL3-LM32450	2073499	→ B-30
LL3-LM32750	2073500	→ B-28, B-30, B-61, B-63
LL3-LM35150	2073488	→ B-28
LL3-LM35450	2073489	→ B-28
LL3-LM35750	2073490	→ B-28
LL3-LM361000	2073494	→ B-33
LL3-LM361250	2073495	→ B-33
LL3-LM36150	2073491	→ B-34
LL3-LM36450	2073492	→ B-34
LL3-LM36750	2073493	→ B-34
LL3-LM37150	2073496	→ B-34
LL3-LM37450	2073497	→ B-34
LL3-LM37750	2073498	→ B-34
LL3-LM38150	2073501	→ B-35
LL3-LM38450	2073502	→ B-35
LL3-LM38750	2073503	→ B-34, B-35, B-61, B-63
LL3-LM38751	2073504	→ B-34, B-35, B-61, B-63
LL3-LM39450	2073505	→ B-35
LL3-LM39750	2073506	→ B-34, B-35, B-62, B-63
LL3-LM401000	2082375	→ B-28
LL3-LT312200	2073487	→ B-30
LL3-LT31450	2077269	→ B-28
LL3-LT31750	2074450	→ B-29
LL3-RR01	5326008	→ B-42, B-75
LL3-TA01	5308128	→ C-82, C-84
LL3-TA01S	5326461	→ C-82, C-84
LL3-TA02	5308129	→ C-82, C-84
LL3-TA03	5326462	→ C-82, C-84
LL3-TA04	5326463	→ C-82, C-84
LL3-TA05	5326464	→ C-82, C-84

Type	Part no.	Page
LL3-TB01	5308050	→ B-23
LL3-TB01-10	5308051	→ B-23
LL3-TB01-30	5315499	→ B-23
LL3-TB02	5308048	→ B-23
LL3-TB03	5308056	→ B-48
LL3-TB05	5325924	→ B-48
LL3-TB06	5325916	→ B-36
LL3-TB07	5325919	→ B-30
LL3-TE01	5325807	→ B-43, B-76
LL3-TE02	5325910	→ B-43, B-76
LL3-TE03	5325908	→ B-43, B-76
LL3-TE04	5325911	→ B-43, B-76
LL3-TE05	5325914	→ B-43, B-76
LL3-TF01	5324242	→ B-63
LL3-TG01	5325940	→ B-67
LL3-TG02	5325943	→ B-36, B-67, B-76
LL3-TG03	5325942	→ B-67
LL3-TG04	5324499	→ B-67, B-76
LL3-TG05	5325921	→ B-30, B-36, B-77
LL3-TH01	5308064	→ B-23, B-56
LL3-TH02	5308065	→ B-23, B-56
LL3-TH06	5325926	→ B-30, B-36
LL3-TH07	5325977	→ B-36, B-56
LL3-TH08	5325978	→ B-56
LL3-TH09	5325979	→ B-56
LL3-TH10	5325970	→ B-56
LL3-TH11	5325971	→ B-56
LL3-TH12	5325972	→ B-57
LL3-TH13	5325973	→ B-57
LL3-TH14	5325974	→ B-57
LL3-TH15	5325975	→ B-36, B-57
LL3-TH16	5325976	→ B-36, B-57
LL3-TJ01	5325915	→ B-23
LL3-TK05	5313034	→ B-30, B-77
LL3-TK16	5313038	→ B-36, B-48
LL3-TK77	5313035	→ B-24, B-77
LL3-TM01	5308068	→ B-24
LL3-TM02	5308069	→ B-24
LL3-TM03	5308070	→ B-30
LL3-TP01	5325925	→ B-48, B-77
LL3-TR01	5308052	→ B-24, B-71, B-77
LL3-TR01-05	5322198	→ B-24, B-71, B-77
LL3-TR02	5308053	→ B-24, B-71, B-77
LL3-TR03	5308054	→ B-31, B-71, B-77
LL3-TR03-2	5308055	→ B-31, B-71, B-77
LL3-TR04	5325918	→ B-31, B-71, B-78
LL3-TR05	5325808	→ B-44, B-71, B-78
LL3-TR06	5325912	→ B-44, B-71, B-78
LL3-TR08	5325984	→ B-37, B-67, B-78
LL3-TR09	5325985	→ B-37, B-67, B-78
LL3-TR10	5325920	→ B-31, B-78
LL3-TR11	5325906	→ B-44, B-78
LL3-TR12	5325907	→ B-44, B-78
LL3-TR13	5325909	→ B-44, B-78
LL3-TS07	5308049	→ B-31
LL3-TS08	5308061	→ B-37, B-48

## LL3-TS10 ... YG8U14-100VA3XLEAX

Type	Part no.	Page
LL3-TS10	5308063	→ B-52
LL3-TS12	5308062	→ B-37, B-48
LL3-TS14	5313039	→ B-52
LL3-TS22	5325944	→ B-37, B-67
LL3-TS22M	5325968	→ B-37, B-57, B-67
LL3-TS40	5323971	→ B-52, B-79
LL3-TT01	5308057	→ B-48
LL3-TV01	5308058	→ B-37, B-48
LL3-TV02	5308059	→ B-37, B-49
LL3-TV04	5308060	→ B-37, B-49
LL3-TV05	5322546	→ B-24, B-38
LL3-TV06	5322547	→ B-24, B-38, B-57
LL3-TV07	5322548	→ B-25, B-38, B-79
LL3-TV08	5325922	→ B-31, B-38
LL3-TV77	5326557	→ B-25, B-38, B-79
LL3-TW01	5315233	→ B-25, B-57, B-63
LL3-TW01-2	5321306	→ B-25, B-57, B-63
LL3-TX01	5324173	→ B-25
LL3-TX02	5325046	→ B-25
LL3-TY01	5308066	→ B-59
LL3-TY02	5308067	→ B-38, B-59
LL3-TY03	5325982	→ B-38, B-59
LL3-TY05	5325980	→ B-59
LL3-TZ05	5325937	→ B-52
LL3-TZ06	5325938	→ B-52
LL3-TZ09	5326598	→ B-52, B-79
LL3-TZ10	5326599	→ B-52
STE-0803-G	6037322	→ E-112
STE-0804-G	6037323	→ E-112
WLL180T-E232	6039100	→ D-100
WLL180T-E333	6049838	→ D-100
WLL180T-E434	6039104	→ D-100
WLL180T-F232	6039098	→ D-100
WLL180T-F333	6042429	→ D-100
WLL180T-F434	6039102	→ D-100
WLL180T-L333	6049837	→ D-100
WLL180T-L432	6039099	→ D-100
WLL180T-L434	6039103	→ D-100
WLL180T-M333	6042428	→ D-100
WLL180T-M432	6039097	→ D-100
WLL180T-M434	6039101	→ D-100
WLL180T-N432	6039094	→ D-100
WLL180T-N434	6039096	→ D-100
WLL180T-N474	6039619	→ D-101
WLL180T-P432	6039093	→ D-100
WLL180T-P434	6039095	→ D-100
WLL180T-P474	6039618	→ D-101
YF8U13-010UA1XLEAX	2094779	→ E-108
YF8U13-020UA1XLEAX	2094782	→ E-108
YF8U13-020VA1XLEAX	2095860	→ E-109
YF8U13-030UA1XLEAX	2094787	→ E-108
YF8U13-050UA1XLEAX	2094788	→ E-108
YF8U13-050VA1XLEAX	2095884	→ E-109
YF8U13-100UA1XLEAX	2094789	→ E-108
YF8U13-100VA1XLEAX	2095885	→ E-109
YF8U13-150VA1XLEAX	2095886	→ E-109

Type	Part no.	Page
YF8U13-200UA1XLEAX	2094790	→ E-108
YF8U14-015VA3XLEAX	2095894	→ E-111
YF8U14-020UA3XLEAX	2094791	→ E-110
YF8U14-020VA3XLEAX	2095888	→ E-111
YF8U14-025VA3XLEAX	2095876	→ E-111
YF8U14-030VA3XLEAX	2095896	→ E-111
YF8U14-050UA3XLEAX	2094792	→ E-110
YF8U14-050VA3XLEAX	2095889	→ E-111
YF8U14-100UA3XLEAX	2094793	→ E-110
YF8U14-100VA3XLEAX	2095890	→ E-111
YF8U14-150UA3XLEAX	2095580	→ E-110
YF8U14-200UA3XLEAX	2095582	→ E-110
YF8UA4-050UB4XLEAX	2096200	→ E-110
YF8UA4-100UB4XLEAX	2096201	→ E-110
YG8U13-020UA1XLEAX	2094794	→ E-108
YG8U13-020VA1XLEAX	2096165	→ E-109
YG8U13-050UA1XLEAX	2095586	→ E-108
YG8U13-050VA1XLEAX	2096166	→ E-109
YG8U13-100UA1XLEAX	2095588	→ E-108
YG8U13-100VA1XLEAX	2096209	→ E-109
YG8U13-150VA1XLEAX	2096210	→ E-109
YG8U14-020UA3XLEAX	2095589	→ E-110
YG8U14-020VA3XLEAX	2095962	→ E-111
YG8U14-050UA3XLEAX	2095590	→ E-110
YG8U14-050VA3XLEAX	2095963	→ E-111
YG8U14-100UA3XLEAX	2095591	→ E-110
YG8U14-100VA3XLEAX	2095964	→ E-111







## REGISTER NOW AT WWW.SICK.COM AND ENJOY THE FOLLOWING BENEFITS






- ✔ View net price and individual discount for each product.
- ✔ Simple ordering and delivery tracking.
- ✔ Overview of all quotes and orders.
- ✔ Create, save and share personalized wish lists.
- ✔ Direct ordering: place large orders quickly.
- ✔ Status of all quotes and orders. Notification by e-mail in the event of status changes.
- ✔ Simple reuse of previous orders.
- ✔ Convenient export of quotes and orders in the right format for your systems.



## SERVICES FOR MACHINES AND SYSTEMS: SICK LifeTime Services

The sophisticated and versatile LifeTime Services perfectly complement SICK’s comprehensive product range. Services range from product-independent consulting to traditional product services.



- 
**Consulting and design**  
 Secure and professional
- 
**Product and system support**  
 Reliable, fast, and on-site
- 
**Verification and optimization**  
 Safe and regularly tested
- 
**Upgrade and retrofits**  
 Simple, safe, and economical
- 
**Training and education**  
 Practical, focused, and professional

## SICK AT A GLANCE

SICK is a leading manufacturer of intelligent sensors and sensor solutions for industrial applications. With more than 9,700 employees and over 50 subsidiaries and equity investments as well as numerous agencies worldwide, SICK is always close to its customers. A unique range of products and services creates the perfect basis for controlling processes securely and efficiently, protecting individuals from accidents, and preventing damage to the environment.

SICK has extensive experience in various industries and understands their processes and requirements. With intelligent sensors, SICK delivers exactly what the customers need. In application centers in Europe, Asia, and North America, system solutions are tested and optimized in accordance with customer specifications. All this makes SICK a reliable supplier and development partner.

Comprehensive services round out the offering: SICK LifeTime Services provide support throughout the machine life cycle and ensure safety and productivity.

**That is “Sensor Intelligence.”**

### **Worldwide presence:**

Australia, Austria, Belgium, Brazil, Canada, Chile, China, Czech Republic, Denmark, Finland, France, Germany, Great Britain, Hungary, Hong Kong, India, Israel, Italy, Japan, Malaysia, Mexico, Netherlands, New Zealand, Norway, Poland, Romania, Russia, Singapore, Slovakia, Slovenia, South Africa, South Korea, Spain, Sweden, Switzerland, Taiwan, Thailand, Turkey, United Arab Emirates, USA, Vietnam.

Detailed addresses and further locations → [www.sick.com](http://www.sick.com)